

John Gardener



Ogród

Outdoor & Gardening



John Gardener



John Gardener oferuje rozwiązania niezbędne do pielęgnacji ogrodów, działek oraz roślin. Misją marki jest pomoc w stworzeniu równie użytkowej, co satysfakcjonującej estetycznie przestrzeni.

Produkty marki JG charakteryzują się trwałością oraz prostotą montażu.

John Gardener troszczy się również o psychiczny komfort klienta, więc każdy z artykułów wykazuje się odpowiednią mocą, ale i możliwie jak największym wyciszeniem silnika.

JG to między innymi kosiarki, narzędzia spalinowe oraz elektryczne wykorzystywane w ogrodnictwie.

Produkty są przeznaczone zarówno dla profesjonalistów jak i amatorów.

John Gardener offers solutions necessary for the care of gardens, plots and plants. The mission of the brand is to help in creating a space that is both functional and aesthetically satisfying. JG products are characterized by durability and ease of assembly. John Gardener also cares about the psychological comfort of the customer, so each of the articles has the appropriate power, but also the greatest possible muting of the engine. JG includes, among others, lawn mowers, gasoline and electric tools used in gardening. Products are intended for both professionals and amateurs.

O firmie

Firma GEKO jest firmą rodzinną o 100% polskim kapitale, działającą nieprzerwanie od początku lat 90 w Kietlinie obok Radomska w województwie Łódzkim.

Nasza firma jest oparta na tradycyjnych wartościach, której głównym celem jest dostarczanie klientom jak najlepszych i najnowocześniejszych rozwiązań.

Priorytetem jest jakość i trwałość produktu oraz pełna satysfakcja klienta, który po zakupie i użytkowaniu produktów naszych marek jest dodatkowo zadowolony, że wybrał rozwiązanie w korzystnej cenie.

About us

GEKO is a family-owned company with 100% Polish capital, operating continuously since the early 90s in Kietlin near Radomsko in the Łódź province.

Our company is based on traditional values, whose main goal is to provide customers with the best and most modern solutions.

The priority is the quality and durability of the product and the full satisfaction of the customer, who after purchasing and using the products of our brands is additionally satisfied that he chose a solution at a favorable price.



John Gardener



Twardy



keltin

Spis treści / Contents:

1. Kosiarki spalinowe / Lawn Mowers	2
2. Kosiarki akumulatorowe / Cordless lawnmowers	4
3. Kosiarki elektryczne / Electric Lawn Mowers	5
4. Podkaszarki spalinowe / Petrol Brush Cutters	6
5. Podkaszarki elektryczne / Electric brush cutter.....	8
6. Części zamienne do podkaszarek / Brush Cutter Spare Parts	10
7. Osprzęt do podkaszarek / Brush Cutter Accessories.....	15
8. Aeratory i wertykulatory / Aerators	21
9. Glebogryzarki / Cultivators	22
10. Dmuchawy/odkurzacze ogrodowe / Leaf Blowers & Garden Vacuums	24
11. Piły, pilarki / Chain Saws	26
12. Nożyce do żywopłotu, trawy i krzewów / Hedge, grass and shrub shears	34
13. Przycinanie i cięcie / Pruning & Cutting	36
14. Rozdrabniacze do gałęzi/siewniki / Garden Shredders/Seeders	52
15. Opryskiwacze ogrodowe / Sprayers.....	53
16. Pompy do wody / Water Pumps	59
17. Wężę i akcesoria ogrodowe / Garden Hoses and accessories.....	71
18. Wężę strażackie / Fire Hoses	88
19. Plandeki / Tarpaulins	92
20. Wiertnice do gleby / Augers	97
21. Łopaty, szpadle, widły i grabie / Shovels, spades, forks and rakes	99
22. Łopaty do śniegu / Snow Shovels	106
23. Małe narzędzia ogrodnicze / Small gardening tools.....	108
24. Miotły i szczotki / Brooms & Brushes	109
25. Rękawice / Gloves	111
26. Wałki przekaźnika mocy / PTO Shafts	116
27. Koła, dętki, opony / Wheels, tubes, tires	118
28. Silniki elektryczne / Electric Engines.....	122
29. Silniki spalinowe / Gas Engines	123
30. Oleje / Oils	125
31. Kanistry / Petrol Cans	126
32. Grille / Grills	128
33. Pozostałe / Other Garden Tools	130
34. Oświetlenie / Lighting	139
35. Myjki ciśnieniowe i akcesoria / Pressure Washers and accessories.....	141
36. Sprzęt i akcesoria turystyczne / Tourist Equipment & Accessories	146
37. Kalosze / Rubber boots.....	154
38. Gumofilce / Rubber boots with felt lining.....	155
39. Chodaki / Clogs.....	156



Kosiarki spalinowe / Lawn Mowers



99cc	moc nominalna 1.6kw
 20/40/60mm	 400mm
 15 cm 15	 45 l
OHV	



GB Lawn mower
DE Rasenmäher
RU Газонокосилки
CZ Sekačka na trávu
SK Kosačka na trávu
HU Fűnyíró
RO Mașină de tuns iarba

Kod EAN

5901477129438

John Gardener Kod produktu **Kosiarka spalinowa 40cm /metal obudowa/ JG G83050 1**



173cc	moc nominalna 3.6kw
 25-70mm	 510mm
 25 cm 20.5	 60 l
OHV	



GB Lawn mower
DE Rasenmäher
RU Газонокосилки
CZ Sekačka na trávu
SK Kosačka na trávu
HU Fűnyíró
RO Mașină de tuns iarba

Kod EAN

5901477129414

John Gardener Kod produktu **#Kosiarka spalinowa JG z napędem 51cm 6w1 G83051 1**



196cc	moc nominalna 3.6kw
25-70mm	510mm
25 cm 20,5	60 l
OHV	system mycia obudowy



GB Lawn mower
DE Rasenmäher
RU Газонокосилки
CZ Sekačka na trávu
SK Kosačka na trávu
HU Fűnyíró
RO Mașină de tuns iarba

Kod EAN

5901477129421

John Gardener Kod produktu **#Kosiarka spalinowa z napędem i elek. startem 51cm G83052 1**

196cc	moc nominalna 3.6kw
25-70mm	510mm
29,5 cm 20,5	60 l
system mycia obudowy	LONCIN



GB Lawn mower
DE Rasenmäher
RU Газонокосилки
CZ Sekačka na trávu
SK Kosačka na trávu
HU Fűnyíró
RO Mașină de tuns iarba

Kod EAN

5901477129384

John Gardener Kod produktu **#Kosiarka spalinowa z napędem 51cm G83053 1**

196cc	moc nominalna 3.6kw
25-70mm	510mm
29,5 cm 20,5	60 l
system mycia obudowy	LONCIN



GB Lawn mower
DE Rasenmäher
RU Газонокосилки
CZ Sekačka na trávu
SK Kosačka na trávu
HU Fűnyíró
RO Mașină de tuns iarba

Kod EAN

5901477129391

John Gardener Kod produktu **#Kosiarka spalinowa z napędem i elek. startem 51cm G83054 1**

139cc	moc nominalna 2.7kw
25-75mm	400mm
20 cm 15	40 l
OHV	



GB Lawn mower
DE Rasenmäher
RU Газонокосилки
CZ Sekačka na trávu
SK Kosačka na trávu
HU Fűnyíró
RO Mașină de tuns iarba

Kod EAN

5901477139239

John Gardener Kod produktu **#Kosiarka spalinowa 40cm /metal obud./ z napędem G83055 1**

139cc	moc nominalna 2.7kw
25-75mm	460mm
17,5 cm 25	60 l
OHV	



GB Lawn mower
DE Rasenmäher
RU Газонокосилки
CZ Sekačka na trávu
SK Kosačka na trávu
HU Fűnyíró
RO Mașină de tuns iarba

Kod EAN

5901477139246

John Gardener Kod produktu **#Kosiarka spalinowa z napędem 46cm G83056 1**

140cc	moc nominalna 2.1kw
25-70mm	510mm
17,5 cm 25	60 l
system mycia obudowy	



GB Lawn mower
DE Rasenmäher
RU Газонокосилки
CZ Sekačka na trávu
SK Kosačka na trávu
HU Fűnyíró
RO Mașină de tuns iarba

Kod EAN

5901477156724

John Gardener Kod produktu **#Kosiarka spalinowa do trawy JG 51cm Multi B&S G83059 1**

Kosiarki akumulatorowe / Cordless lawnmowers



38 cm	45L
25-75 mm	13 KG
SILNIK BEZSZCZOTKOWY BRUSHLESS MOTOR	2x 40V 4.0Ah



CoreX

GB Brushless cordless lawn mower
DE Bürstenloser Akku-Rasenmäher
RU Бесщеточная аккумуляторная газонокосилка
CZ Bezuhlíková akumulátorová sekačka na trávu
SK Bezuhlíková akumulátorová kosačka na trávu
HU Szénkefe nélküli akkumulátoros fűnyíró
RO Mașină de tuns iarba cu acumulator fără perii

Kod EAN
 5903418302993

John Gardener
Kosiarka akumulatorowa bezszczotkowa CoreX G80686 1

32 cm	30L
25-65 mm	8.2 KG
SILNIK BEZSZCZOTKOWY BRUSHLESS MOTOR	20V 4.0Ah



CoreX

GB Brushless cordless lawn mower
DE Bürstenloser Akku-Rasenmäher
RU Бесщеточная аккумуляторная газонокосилка
CZ Bezuhlíková akumulátorová sekačka na trávu
SK Bezuhlíková akumulátorová kosačka na trávu
HU Szénkefe nélküli akkumulátoros fűnyíró
RO Mașină de tuns iarba cu acumulator fără perii

Kod EAN
 5903418302986

John Gardener
Kosiarka akumulatorowa bezszczotkowa CoreX G80685 1

20V	4Ah
-----	-----



CoreX

GB Battery for cordless tools
DE Akku für Akku-Werkzeuge
RU Аккумулятор для аккумуляторных инструментов
CZ Baterie pro akumulátorové nářadí
SK Batéria pre akumulátorové náradie
HU Akkumulátor akkumulátoros szerszámokhoz
RO Baterie pentru scule cu acumulator

Kod EAN
 5903418303044

John Gardener
Bateria 4.0Ah 20V do narzędzi akumulatorowych CoreX G80681 50

20V DC 2A



CoreX

GB Battery for cordless tools
DE Akku für Akku-Werkzeuge
RU Аккумулятор для аккумуляторных инструментов
CZ Baterie pro akumulátorové nářadí
SK Batéria pre akumulátorové náradie
HU Akkumulátor akkumulátoros szerszámokhoz
RO Baterie pentru scule cu acumulator

Kod EAN
 5903418303051

John Gardener
Ładowarka typu baza 2A 20V do narzędzi akumulatorowych CoreX G80683 42

Kosiarki elektryczne / Electric Lawn Mowers



230V~50Hz	pobór prądu 1200W
25/40/55mm	320mm
3000obr/min	35 l



230V~50Hz	pobór prądu 1200W
25/60mm	320mm
3100obr/min	30 l



GB Electric lawn mower
DE Elektrischer Rasenmäher
RU Электрическая газонокосилка
CZ Elektrické sekačky na trávu
SK Elektrická sekačka na trávu
HU Elektromos fűnyíró
RO Mașină de tuns gazon electric



Kod EAN
5901477156205
Kod produktu
G83025 1

GB Electric lawn mower
DE Elektrischer Rasenmäher
RU Электрическая газонокосилка
CZ Elektrické sekačky na trávu
SK Elektrická sekačka na trávu
HU Elektromos fűnyíró
RO Mașină de tuns gazon electric



Kod EAN
5901477156212
Kod produktu
Kosiarka elektryczna 32cm model: SHARP G83026 1

230V~50Hz	pobór prądu 1300W
25/60mm	320mm
3100obr/min	30 l



230V~50Hz	pobór prądu 1700W
25/75mm	380mm
3450obr/min	40 l



GB Electric lawn mower
DE Elektrischer Rasenmäher
RU Электрическая газонокосилка
CZ Elektrické sekačky na trávu
SK Elektrická sekačka na trávu
HU Elektromos fűnyíró
RO Mașină de tuns gazon electric



Kod EAN
5901477156229
Kod produktu
Kosiarka elektryczna 32cm model: HD EXTREME G83027 1

GB Electric lawn mower
DE Elektrischer Rasenmäher
RU Электрическая газонокосилка
CZ Elektrické sekačky na trávu
SK Elektrická sekačka na trávu
HU Elektromos fűnyíró
RO Mașină de tuns gazon electric



Kod EAN
5901477161421
Kod produktu
Kosiarka elektryczna 38cm reg. wys. model: STRONG G83028 1

Podkaszarki spalinowe / Petrol Brush Cutters



52cc	8000obr/min
255mm	425mm
25 : 1	1000ml



GB Gasoline brush cutter
 DE Benzin freischneider
 RU Бензиновый триммер
 CZ Křovinořez
 SK Křovinořez
 HU Benzines bozótívágó
 RO Motocoasa benzina



Johr Gardener
 Podkaszarka spalinowa multifunkcyjna 4w1
 Kod produktu
G81057 1

52cc	moc nominalna 1.6kW
255mm	425mm
25 : 1	850ml
7000obr/min	



GB Gasoline brush cutter
 DE Benzin freischneider
 RU Бензиновый триммер
 CZ Křovinořez
 SK Křovinořez
 HU Benzines bozótívágó
 RO Motocoasa benzina



Johr Gardener
 Podkaszarka spalinowa antywibracyjna 52cc
 Kod produktu
G81059 1



42,7cc
 255mm
 25 : 1
 8000ob/min
 moc nominalna
 1.3kw
 410mm
 1000ml

GB Gasoline brush cutter
 DE Benzin freischneider
 RU Бензиновый триммер
 CZ Křovinořez
 SK Krovinořez
 HU Benzines bozótvágo
 RO Motocoasa benzina

Kod EAN
 5901477121074

John Gardener Kod produktu
Podkaszarka spalinowa z dodatkowym wyposażeniem G81061 1



49,7cc
 255mm
 25 : 1
 8000ob/min
 moc nominalna
 1.3kw
 425mm
 1000ml

GB Gasoline brush cutter
 DE Benzin freischneider
 RU Бензиновый триммер
 CZ Křovinořez
 SK Krovinořez
 HU Benzines bozótvágo
 RO Motocoasa benzina

Kod EAN
 5901477116742

GAZELA Kod produktu
Podkaszarka spalinowa GAZELA G81062 1



37.7cc
 255mm
 0,1L
 7500ob/min
 moc nominalna
 1.3kw
 425mm
 630ml
 Typ silnika:
 4-suwowy
 chłodzony
 powietrzem

GB Gasoline brush cutter
 DE Benzin freischneider
 RU Бензиновый триммер
 CZ Křovinořez
 SK Krovinořez
 HU Benzines bozótvágo
 RO Motocoasa benzina

Kod EAN
 5901477186318

John Gardener Kod produktu
Podkaszarka spalinowa 4-suwowa JG z dodatkowym wyposażeniem G81047 1/2



Podkaszarki elektryczne / Electric brush cutter

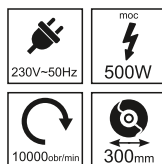
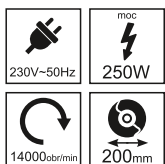

GB Electric trimmer
DE Elektro-Rasentrimmer
RU Электрический триммер
CZ Elektrická sekačka
SK Elektrická kosačka
HU Elektromos fűnyíró
RO Cositoare electrică



John Gardener
Podkaszarka elektryczna do trawy G83015 20

GB Electric trimmer
DE Elektro-Rasentrimmer
RU Электрический триммер
CZ Elektrická sekačka
SK Elektrická kosačka
HU Elektromos fűnyíró
RO Cositoare electrică



John Gardener
Podkaszarka elektryczna do trawy PROFÍ G83016 4



GB Nylon cutter
DE Trimmerkopf
RU Головка триммерная
CZ Strunová hlava
SK Strunová hlava
HU Damil fej
RO Cap cu cablu



John Gardener
Głowica żyłkowa do kosy elektrycznej G83015 250W CG83015-1 300



GB Nylon cutter
DE Trimmerkopf
RU Головка триммерная
CZ Strunová hlava
SK Strunová hlava
HU Damil fej
RO Cap cu cablu



John Gardener
Głowica żyłkowa do kosy elektrycznej G83016 500W CG83016-1 100

21 V
2x2.0 Ah
Li-Ion

600W

1000obr/min

200mm

99-135cm

30-50mm



GB Cordless grass trimmer
DE Akku-Rasentrimmer
RU Аккумуляторный триммер
CZ Akumulátorová strunová sekačka
SK Akumulátorový krovinořez
HU Akkumulátoros fűszegélynyíró
RO Trimmer cu acumulator

1x 2x 10x 20x

Kod EAN

5903418302931

John Gardener Kod produktu

Podkaszarka akumulatorowa 2x2.0Ah 21V-zestaw XXL G80668 1



FOR
G80668

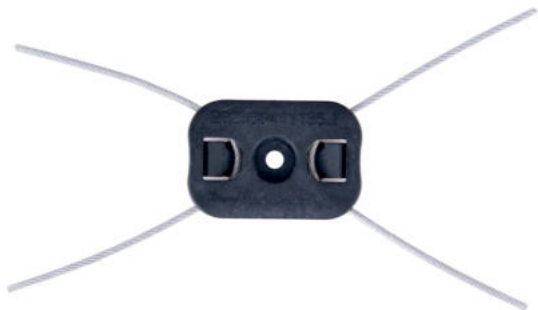

GB Trimmer head for cordless grass trimmer
DE Fadenkopf für Akku-Rasentrimmer
RU Триммерная головка для аккумуляторного триммера
CZ Strunová hlava pro akumulátorovou sekačku
SK Strunová hlava pre akumulátorový krovinořez
HU Damilfej akkumulátoros fűszegélynyíróhoz
RO Cap de tăiere pentru trimmer cu acumulator

Kod EAN

5903418303891

John Gardener Kod produktu

Głowica żyłkowa do podkaszarki akumulatorowej G80668 CG80668F 100

FOR
G80668

x40T

150mm



GB Carbide blade for cordless grass trimmer
DE Hartmetallklinge für Akku-Rasentrimmer
RU Твердосплавный диск для аккумуляторного триммера
CZ Karbidový kotúč pro akumulátorovou sekačku
SK Karbidový kotúč pre akumulátorový krovinořez
HU Keményfém tárcsa akkumulátoros fűszegélynyíróhoz
RO Disc cu plăcuțe din carbură pentru trimmer cu acumulator

Kod EAN

5903418303884

John Gardener Kod produktu

Tarcza z widzą do podkaszarki akumulatorowej G80668 CG80668E 50

FOR
G80668

6pcs

135mm

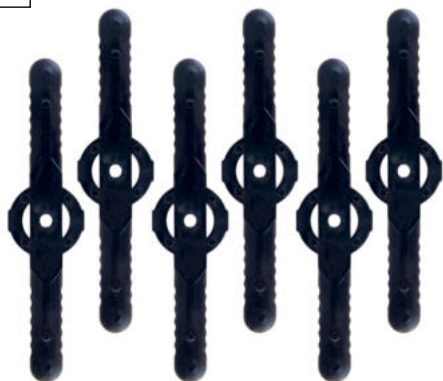

GB Plastic blades for cordless grass trimmer
DE Kunststoffmesser für Akku-Rasentrimmer
RU Пластиковые лезвия для аккумуляторного триммера
CZ Plastové nože pro akumulátorovou sekačku
SK Plastové nože pre akumulátorový krovinořez
HU Műanyag kések akkumulátoros fűszegélynyíróhoz
RO Lame din plastic pentru trimmer cu acumulator

Kod EAN

5903418303914

John Gardener Kod produktu

Ostrza plastikowe do podkaszarki akumulatorowej G80668 CG80668H 50

FOR
G80668

150mm



GB Metal blade for cordless grass trimmer
DE Metallklinge für Akku-Rasentrimmer
RU Металлическое лезвие для аккумуляторного триммера
CZ Kovový nůž pro akumulátorovou sekačku
SK Kovový nôž pre akumulátorový krovinořez
HU Fém penge akkumulátoros fűszegélynyíróhoz
RO Lamă metalică pentru trimmer cu acumulator

Kod EAN

5903418303907

John Gardener Kod produktu

Ostrze metalowe do podkaszarki akumulatorowej G80668 CG80668G 100

Części zamienne do podkaszarek / Brush Cutter Spare Parts



43cc
8000obr/min

25 : 1
1200ml



GB Engine for gasoline brush cutter
DE Motor für Benzin Freischneider
RU Двигатель для бензиновый триммер
CZ Motor k benzínovému křovinořezu
SK Motor k benzínovému křovinořezu
HU Motor benzines bozótvágozóhoz
RO Motor pentru motocosiitoare pe benzina

John Gardener
Kod produktu 5901477129179
Silnik do podkaszarki spalinowej G81064 4

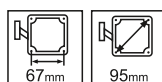

GB Starter
DE Starter
RU Crапrep
CZ Startování
SK Štartovanie
HU Indító
RO Demaror

John Gardener
Kod produktu 5901477123894
Starter do podkaszarki G81065A 100

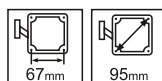

GB Starter
DE Starter
RU Crапrep
CZ Startování
SK Štartovanie
HU Indító
RO Demaror

John Gardener
Kod produktu 5901477136030
Starter do podkaszarki no.3 ze sprężyną G81065B 100

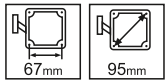

GB Starter
DE Starter
RU Стартёр
CZ Startování
SK Štartovanie
HU Indító
RO Demaror



John Gardener Kod produktu Starter do podkaszarki no.2 G81068A 100



GB Starter
DE Starter
RU Стартёр
CZ Startování
SK Štartovanie
HU Indító
RO Demaror



John Gardener Kod produktu Starter do podkaszarek i opryskiwaczy spalinowych G81068Z 100



GB Wall bracket-holder for Brushcutter
DE Wandhalterung für Freischneider
RU Настенный кронштейн-держатель для Brushcutter
CZ Držák na zeď pro křovinořez
SK Držiak na stenu pre křovinořez
HU Fali konzoltartó a bozótágóhoz
RO Suport pentru perete pentru decupător



John Gardener Kod produktu Uchwył-wieszak na ścianę do kosi podkaszarki G81066C 100



GB Element for fastening handles
DE Griffhalter für Motorsense
RU Кронштейн крепления руля бензокосы
CZ Držák rúčky pro křovinořez
SK Držiak rúčky pro křovinořez
HU Fogantyú rögzító
RO Element pentru mâner de fixare



John Gardener Kod produktu Krzyżak do mocowania rączki kosi 28mm G81065G 100



GB Knife for shield set with 3 screws
DE Messer für Rasenmäher
RU Нож для обрезки лески бензокосы
CZ Nůž pro sekačku
SK Nôž pre kosačku
HU Fűnyíró penge
RO Cuțit pentru mașina de tuns iarba



John Gardener Kod produktu Nóż odcinający żyłkę do kosi spalinowej G81065H 300



GB Part of shield set
DE Schutzhaube für Schnitffaden
RU Гребень на бензокосы
CZ Ochranný kryt sečení
SK Ochranný kryt kosenia
HU Védőburkolat fűkaszához
RO Cuțit pentru carcasa protecție motocoasa



John Gardener Kod produktu Grzebień osłony do kosi spalinowej G81065I 250



GB Cable for oil tank
DE Schlauch für Sense
RU Топливопровод в сборе для бензокосы
CZ Hadice s filtrem pro křovinořez
SK Hadica s filtrom pre křovinořez
HU Olajtartály kábel
RO Filtru + furtun benzina motocoasa



John Gardener Kod produktu Wężyk paliwa z filtrem do kosi spalinowej G81065J 500



GB Nylon cutter
DE Trimmerkopf
RU Головка триммерная
CZ Strunová hlava
SK Strunová hlava
HU Damil fej
RO Cap cu cablu



John Gardener Kod produktu Głowica żyłkowa do podkaszarki NEW G81065K 50

40T



GB 40T blade
DE 40 Zähne Rodungssägeblatt
RU Диск для кустореза 30зубы
CZ Kotoúč 30-zubý
SK Kotúč 30-zubý
HU Vágókorong
RO Disc Taietor



John Gardener Kod produktu Tarcza tnąca do podkaszarki 40-zębów G81065L 100



GB Set of gaskets
DE Dichtungssatz für Motorsense
RU Комплект уплотнителей для бензокосилки
CZ Set podložek a těsnění pro křovinořez
SK Set podložiek a tesnení pre křovinořez
HU Tömítő készlet fűkaszához
RO Set garnituri drujba



John Gardener Kod produktu Zestaw membran gaźnika do podkaszarki spalinowej G81065M 500



GB Cap for oil tank for brushcutter
DE Tankdeckel öl tank passend
RU Крышка масляного бака для бензокосы
CZ Paliivová nádrž čínské křovinořez
SK Paliivová nádrž čínskej křovinořez
HU Benzín sapka
RO Rezervor benzina drujba



John Gardener Kod produktu Korek zbiornika paliwa do kosi G81065N 200



GB Set of gaskets
DE Dichtungssatz für Motorsense
RU Комплект уплотнителей для бензокосилки
CZ Set podložek a těsnění pro křovinořez
SK Set podložiek a tesnení pre křovinořez
HU Tömítő készlet fűkaszához
RO Set garnituri drujba



John Gardener Kod produktu Komplet podkładek-uszczeliek do podkaszarki G81065P 500



GB Carburetor
DE Vergaser
RU карбюратор
CZ Karburátor
SK Karburátor
HU Karburátor
RO Carburator

Kod EAN
5901477123955

John Gardener Kod produktu 
Gaźnik do kosy spalinowej uniwersalny G81066G 100



GB Clutch Assy
DE die Kiefer zu der Kupplung
RU Челюсти к муфте
CZ Spojka pro křovinořez
SK Spojka pre krovinořez
HU Tengelykapcsoló fűkaszához
RO Ambreiaj drujba

Kod EAN
5901477127045

John Gardener Kod produktu 
Szczęki do sprzęgła podkaszarki spalinowej G81066R 100



GB Electronic ignition
DE Zündspule für Benzin Freischneider
RU катушка зажигания для бензиновый триммер
CZ Indukční cívka
SK Indukčná cievka
HU Gyújtótekercs fűkaszához
RO Bobina de inducție

Kod EAN
5901477123962

John Gardener Kod produktu 
Cewka zapłonowa kosy spalinowej G81066W 100



GB Flywheel
DE Schwungrad
RU Маховик
CZ Setvačnik
SK Zotrvačnik
HU Lendkerék
RO Volantul

Kod EAN
5901477127052

John Gardener Kod produktu 
Koło zamachowe do kosy spalinowej G81066X 1



GB Connecting rod
DE Pleuel
RU Шатун
CZ Klukový hřídel pro křovinořez
SK Klukový hriadeľ pre krovinořez
HU Hajtókár fűkaszához
RO Biela

Kod EAN
5901477127069

John Gardener Kod produktu 
Korbowód do kosy spalinowej G81067G 50



GB Spark plug
DE Zündkerze
RU Свеча зажигания
CZ Zapařovací svíčka
SK Zapařovacia sviečka
HU Gyújtógyertya
RO Bujii de aprindere

Kod EAN
5901477123979

John Gardener Kod produktu 
Świeca zapłonowa kosy spalinowej G81067S 500



GB Carbureator base
DE Vergaserunterteil
RU Карбюраторная база
CZ Základna karburátoru
SK Základňa karburátora
HU Karburátor alap
RO Baza carburatorului

Kod EAN
5901477128172

John Gardener Kod produktu 
Podstawa gaźnika G81067X 1



GB Right handlebar with controller
DE Griff mit für die Motorsense
RU Ручка регулятор
CZ Rukojeť na křovinořez
SK Rukoväť na krovinořez
HU Fűkasza alkatrés�
RO Controlor

Kod EAN
5901477124228

John Gardener Kod produktu 
Prawa rączka z regulatorem do kosy spalinowej G81068R 100



GB Left handle for brush cutter
DE Linker Griff für Motorsense
RU Левая рукоятка для бензокосы
CZ Levá rukojeť pro křovinořez
SK Ľavá rukoväť pre krovinořez
HU Bal oldali fogantyú bozótívágóhoz
RO Măner stâng pentru motocoasă

Kod EAN
5901477197468

John Gardener Kod produktu 
Lewa rączka do kosy spalinowej G81068B 80



GB Right handlebar with controller
DE Griff mit für die Motorsense
RU Ручка регулятор
CZ Rukojeť na křovinořez
SK Rukoväť na krovinořez
HU Fűkasza alkatrés�
RO Controlor

Kod EAN
5901477197475

John Gardener Kod produktu 
Prawa rączka z przełącznikiem do kosy spalinowej G81068C 50



GB Piston
DE Kolben
RU Поршень
CZ Pist
SK Piest
HU Dugattyú
RO Piston

Kod EAN
5901477127106

John Gardener Kod produktu 
Tłok kosy spalinowej JG G81068E 1



GB Bolt
DE Bolzen
RU Болт
CZ Šroub
SK Skrutka
HU Csavar
RO Bolț

Kod EAN
5901477127113

John Gardener Kod produktu 
Sworzeń tłoka kosy spalinowej G81068G 1



GB Fuel tank
DE Kraftstofftank
RU Топливный бак
CZ Palivová nádrž pro křovinořezy
SK Palivová nádrž pre krovinořezy
HU Üzemanyag tartály
RO Combustibil motocoasa



5901477123986

John Gardener Kod produktu **Zbiornik paliwa kosi spalinowej G81068J 50**



GB Head with 7teeth mode 26mm
DE Kegelfradgetriebe 7t 26mm
RU Угловая головка 7 зубов 26мм
CZ Úhlová převodovka křovinořezy
SK Úhlová převodovka krovinořezy
HU Kúpfogaskerék
RO Cap trimmer



5901477127120

John Gardener Kod produktu **Przekładnia kątowna do kosi spalinowej 7frezów 26mm G81068M 50**



GB Head with 9teeth mode 26mm
DE Kegelfradgetriebe 9t 26mm
RU Угловая головка 9 зубов 26мм
CZ Úhlová převodovka křovinořezy
SK Úhlová převodovka krovinořezy
HU Kúpfogaskerék
RO Cap trimmer



5901477124198

John Gardener Kod produktu **Przekładnia kątowna do kosi spalinowej 9frezów 26mm G81069B 50**



GB Head with 9teeth mode 28mm
DE Kegelfradgetriebe 9t 28mm
RU Угловая головка 9 зубов 28мм
CZ Úhlová převodovka křovinořezy
SK Úhlová převodovka krovinořezy
HU Kúpfogaskerék
RO Cap trimmer



5901477124204

John Gardener Kod produktu **Przekładnia kątowna do kosi spalinowej 9frezów 28mm G81069C 50**



GB Clutch cover
DE Kupplungsdeckel
RU Крышка сцепления
CZ Buben spojky pro křovinořez
SK Buben spojky pre krovinořez
HU Kuplungfedél
RO Carcase ambreiaj



5901477124105

John Gardener Kod produktu **Kosz sprzęgła 9 zębów G81069F 100**



GB Clutch cover
DE Kupplungsdeckel
RU Крышка сцепления
CZ Buben spojky pro křovinořez
SK Buben spojky pre krovinořez
HU Kuplungfedél
RO Carcase ambreiaj



5901477127168

John Gardener Kod produktu **Ośłona sprzęgła (kosz) 7 zębów G81068U 100**



GB Connector
DE Verbindungstück
RU Верхний редуктор бензокосы
CZ Spojkový koš pro křovinořez
SK Spojkový koš pre krovinořez
HU Ósszekötőelem
RO Conector



5901477127175

John Gardener Kod produktu **Bęben sprzęgła(kosz)kosi spal. 7 frezów 26mm G81068W 50**



GB Supper strap
DE Doppelschultergurt
RU Ремень наплечный двойной
CZ Dvojramenný popruh
SK Dvojramenný popruh
HU Dupla vállpánt
RO Ham Motocoasa



5901477128561

John Gardener Kod produktu **Szelki do podkaszarki typ lekki G81068X 50**



GB Supper strap
DE Doppelschultergurt
RU Ремень наплечный двойной
CZ Dvojramenný popruh
SK Dvojramenný popruh
HU Dupla vállpánt
RO Ham Motocoasa



5903418303068

John Gardener Kod produktu **Szelki do kosi spalinowej - komfortowe - uniwersalne G81065R 25**



GB Supper strap
DE Doppelschultergurt
RU Ремень наплечный двойной
CZ Dvojramenný popruh
SK Dvojramenný popruh
HU Dupla vállpánt
RO Ham Motocoasa



5903418303075

John Gardener Kod produktu **Szelki do kosi spalinowej - plecakowe- mocne G81065S 25**



GB Supper strap
DE Doppelschultergurt
RU Ремень наплечный двойной
CZ Dvojramenný popruh
SK Dvojramenný popruh
HU Dupla vállpánt
RO Ham Motocoasa



5901477154096

John Gardener Kod produktu **Szelki do kosi spalinowej JG PREMIUM G81065C 40**



GB Supper strap
DE Doppelschultergurt
RU Ремень наплечный двойной
CZ Dvojramenný popruh
SK Dvojramenný popruh
HU Dupla vállpánt
RO Ham Motocoasa



5901477185953

John Gardener Kod produktu **Szelki do podkaszarki - typ. wygodny G81067Y 20**



GB Supper strap
DE Doppelschultergurt
RU Ремень наплечный двойной
CZ Dvojrámenný popruh
SK Dvojramenný popruh
HU Dupla vállpánt
RO Ham Motocoasa



John Gardener Kod produktu **Szelki do kosi typ ciężki** G81069I 40



GB Clutch cover
DE Kupplungsdeckel
RU Крышка сцепления
CZ Buben spojky pro křovinořez
SK Buben spojky pre krovinořez
HU Kuplungfedél
RO Carcase ambreiaj



John Gardener Kod produktu **Walek napędowy do kosi spalinowej 9 frezów** G81069D 100



GB Clutch cover
DE Kupplungsdeckel
RU Крышка сцепления
CZ Buben spojky pro křovinořez
SK Buben spojky pre krovinořez
HU Kuplungfedél
RO Carcase ambreiaj



John Gardener Kod produktu **Walek napędowy do kosi spalinowej-kwadrat** G81069E 50



GB Clutch cover
DE Kupplungsdeckel
RU Крышка сцепления
CZ Buben spojky pro křovinořez
SK Buben spojky pre krovinořez
HU Kuplungfedél
RO Carcase ambreiaj



John Gardener Kod produktu **Walek napędowy do kosi spalinowej 7 frezów** G81068N 50



GB Clutch cover
DE Kupplungsdeckel
RU Крышка сцепления
CZ Buben spojky pro křovinořez
SK Buben spojky pre krovinořez
HU Kuplungfedél
RO Carcase ambreiaj



John Gardener Kod produktu **Kosz sprzęgła kwadrat** G81069G 100



GB Connector
DE Verbindungstück
RU Верхний редуктор бензокосы
CZ Spojkový koš pro křovinořez
SK Spojkový koš pre krovinořez
HU Összekötőelem
RO Conector



John Gardener Kod produktu **Bęben sprzęgła, kosz do kosi spal. 9 frezów 28mm** G81069H 50



GB Shield set with knife
DE Messer Schutz für Motorsense
RU Кожух защитный для бензокос с креплением
CZ Kryt žací hlavy pro křovinořez
SK Kryt žacej hlavy pre krovinořez
HU Védőburkolat fűkaszához
RO Carcasa protectie motocoasa



John Gardener Kod produktu **Ostona do kosi spalinowej z nożem** G81068O 50



GB Ear muff
DE Gehörschutz
RU Средства защиты слуха
CZ Chrániče sluchu
SK Chrániče sluchu
HU Fülvédőt
RO Antifoane



John Gardener Kod produktu **Nauszniki ochronne** G81069J 50



GB Mask
DE Kopfschutzschild
RU Маска
CZ Ochranná maska
SK Ochranná maska
HU Védőmaszk
RO Masca protectie

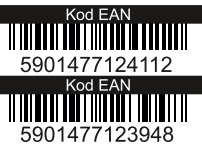

John Gardener Kod produktu **Maska ochronna z siatką JG do kos, pił** G81069K 48
Maska ochronna z osłoną PCV do kos, pił G81065Z 48



GB Head 9 teeth 28mm Japan Type
DE Kegelradgetriebe 9t 28mm
RU Угловая головка 9 зубов 28мм
CZ Úhlová převodovka křovinořezu
SK Úhlová prevodovka krovinořezu
HU Kúpfogaskerék
RO Cap trimmer



John Gardener Kod produktu **Przekładnia kątowna, do kosi PROFİ 9 frezów 28mm** G81069O 50



GB Connector
DE Verbindungstück
RU Верхний редуктор бензокосы
CZ Spojkový koš pro křovinořez
SK Spojkový koš pre krovinořez
HU Összekötőelem
RO Conector



John Gardener Kod produktu **Bęben sprzęgła (kosz) kosi spal. 9 frezów 26mm** G81069P 50



GB Nut
DE Nuss
RU Гайка
CZ Ořech
SK Ořech
HU Dió
RO Piuliță



John Gardener Kod produktu **Nakrętka mocowania przekładni-noża kosi spalinowej** G81069R 400



GB Spring for clutch assy
DE Kupplungsfeder
RU Пружина сцепления
CZ Pružina spojky ku křovinořezu
SK Pružina spojky ku křovinořezom
HU Kuplung rugó
RO Arc ambreiaj



Kod EAN
5901477128578

John Gardener Kod produktu 50
Sprężyna do szcęk sprzęgła G81069T 200



GB Head with square mode 26mm
DE Kegelradgetriebe 26mm
RU Угловая головка 26мм
CZ Úhlová převodovka křovinořezu
SK Uholová prevodovka křovinořezu
HU Kúpogaskerék
RO Cap trimmer



Kod EAN
5901477128585

John Gardener Kod produktu 50
Przekładnia kątowna, do kosy spal. 26mm kwadrat G81069W 50



GB Cylinder set
DE Zylinder + Kolben
RU Цилиндр+ поршень
CZ Válcce kompletní
SK Válcce kompletné
HU Komplet henger+ dugó gyűrű
RO Kit cilindru



Kod EAN
5901477124181

John Gardener Kod produktu 50
Komplet cylinder+tłok do kosy spalinowej 52cc 44mm G81106 50



GB Cylinder set
DE Zylinder + Kolben
RU Цилиндр+ поршень
CZ Válcce kompletní
SK Válcce kompletné
HU Komplet henger+ dugó gyűrű
RO Kit cilindru



Kod EAN
5901477124150

John Gardener Kod produktu 50
Komplet cylinder+tłok do kosy spalinowej 43cc 40mm G81110 50

Osprzęt do podkaszarek / Brush Cutter Accessories



GB Case for brushcutter
DE Koffer für Freischneider
RU Чехол для кустореза
CZ Pouzdro pro křovinořez
SK Puzdro na křovinořez
HU Szerszám kefékhez
RO Cauciuc pentru percutie



Kod EAN
5901477153396

John Gardener Kod produktu 36
Pokrowiec podkaszarki spalinowej John Gardener G83018 36

montaż: walek 9 frezów
średnica rury 28 mm
← 320mm →



GB Tiller
DE Kultivator
RU Культиватор
CZ Kultivátor
SK Kultivátor
HU Kultivátor
RO Cultivator



Kod EAN
5901477150814

John Gardener Kod produktu 6
Glebgryzarka-adapter do kosy spal. 32cm (28mm) G84007 6



GB Mixing container
DE Mischbehälter
RU Ёмкость для приготовления смеси
CZ Nádoba na přípravu směsi
SK Nádoba na prípravu zmesi
HU Kevertartály
RO Recipient pentru prepararea amestecului



Kod EAN
5901477197482

John Gardener Kod produktu 50
Zbiornik do sporządzania mieszanki oleju i paliwa 1L G81068D 50

montaż:
wałek
9 frezów
średnica
rury
28 mm



GB Water pump - adaptor for brush cutter
DE Wasserpumpe - Adapter für Freischneider
RU Водяной насос - адаптер для кусторезов
CZ Vodní pumpa - adaptér na křovinořez
SK Vodná pumpa - adaptér na krovínorez
HU Vízpumpa - adapter bozótvágóhoz
RO Pompa de apa - adaptor pentru motocosita



Pompa do wody – przystawka do kosy spalynowej 28mm 9 frezów G81064D 20

24T
255mm
25.4mm

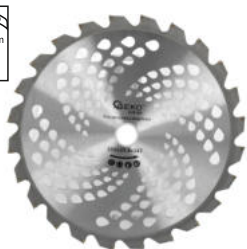

GB Blade
DE Rodungssägeblatt
RU Диск для кустореза
CZ Nůž křovinořezu
SK Nôž krovínorezu
HU Körfűrészlap
RO Disc taietor motocosa



Tarcza z widią do podkaszarki spal. 255x25,4mmx24T G78180 50

60T
255mm
25.4mm

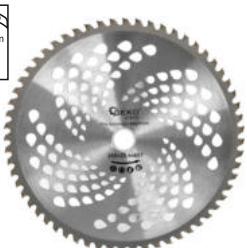

GB Blade
DE Rodungssägeblatt
RU Диск для кустореза
CZ Nůž křovinořezu
SK Nôž krovínorezu
HU Körfűrészlap
RO Disc taietor motocosa



Tarcza z widią do podkaszarki spal. 255x25,4mmx60T G78182 50



GB Circular brush
DE Stahldraht-Scheibenbürste
RU Щетка круглая
CZ Okružní kartáč drátěný
SK Okružná kefa drátěný
HU Tarcás drótkefe
RO Perie rotunda pt. bormasina



Szczotka druciana do podkaszarki 200x25,4 PROF1 G00649 20



GB Circular brush
DE Stahldraht-Scheibenbürste
RU Щетка круглая
CZ Okružní kartáč drátěný
SK Okružná kefa drátěný
HU Tarcás drótkefe
RO Perie rotunda pt. bormasina



Szczotka druciana do podkaszarki 200x25,4mm Keltin K00035 50

40T
255mm
25.4mm

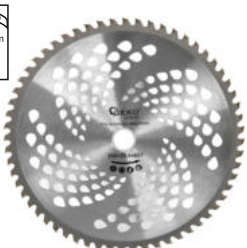

GB Blade
DE Rodungssägeblatt
RU Диск для кустореза
CZ Nůž křovinořezu
SK Nôž krovínorezu
HU Körfűrészlap
RO Disc taietor motocosa



Tarcza z widią do podkaszarki spal. 255x25,4mmx40T G78181 50



GB Nylon cutter
DE Trimmerkopf
RU Головка триммерная
CZ Strunová hlava
SK Strunová hlava
HU Damil fej
RO Cap cu cablu



Głowica żyłkowa AUTOMAT do podkaszarki G81066Y 50



GB Nylon cutter
DE Trimmerkopf
RU Головка триммерная
CZ Strunová hlava
SK Strunová hlava
HU Damil fej
RO Cap cu cablu



Głowica żyłkowa od podkaszarki standard G81066 50

8T



GB 8T blade
DE 8 Zähne Rodungssägeblatt
RU Диск для кустореза 8зубы
CZ Kotoúč 8-zubý
SK Kotoúč 8-zubý
HU Vágókorong
RO Disc Taietor



Tarcza tnąca do kosy 8-zębów G81069L 100

3T



GB 3T blade
DE 3 Zähne Rodungssägeblatt
RU Диск для кустореза 3зубы
CZ Kotoúč 3-zubý
SK Kotoúč 3-zubý
HU Vágókorong
RO Disc Taietor



Tarcza tnąca do kosy- 3-zębý G81069M 100



GB Nylon cutter
DE Trimmerkopf
RU Головка триммерная
CZ Strunová hlava
SK Strunová hlava
HU Damil fej
RO Cap cu cablu



Głowica żyłkowa PROF1/czarna/ do podkaszarki G81069N 50



GB Nylon brush for brushcutter
DE Nylonbürste für Freischneider
RU Нейлоновая щетка для мотокосы
CZ Nylonový kartáč pro křovinořez
SK Nylonová kefa pre krovínorez
HU Nylon kefe ecsetvágóhoz
RO Perie de nailon pentru perie



Szczotka nylonowa do kosy 200x25,4mm G81069S 20



GB Trimmer plate for brush cutter
DE Fadenkopf für motosense
RU Триммер кусторезов головка резак
CZ Kovová strunová hlava na křovinořez
SK Kovová strunová hlava na křovinořez
HU Sövényvágó fej
RO Cap mosor trimmer



John Gardener Kod produktu **Trymer do podkaszarki spalinowej G81069U 100**



GB Nylon cutter
DE Trimmerkopf
RU Головка триммерная
CZ Strunová hlava
SK Strunová hlava
HU Damil fej
RO Cap cu cablu



John Gardener Kod produktu **Głowica żyłkowa alu-szybkiego montażu żyłki G81069X 50**



GB Nylon cutter
DE Trimmerkopf
RU Головка триммерная
CZ Strunová hlava
SK Strunová hlava
HU Damil fej
RO Cap cu cablu



John Gardener Kod produktu **Głowica żyłkowa EASY-LOAD do podkaszarki G81069Y 50**

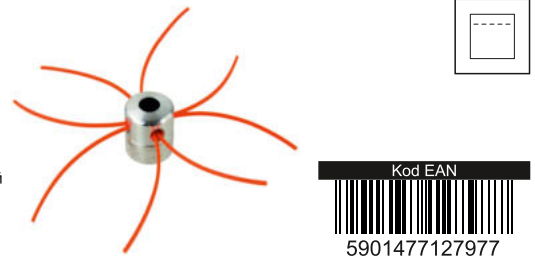

GB Line head
DE Trimmerkopf
RU Головка с леской
CZ Strunová hlava
SK Strunová hlava
HU Damil fej
RO Cap cu cablu



John Gardener Kod produktu **Aluminiowa głowica z żyłką do kosy Autocut G81069Z 100**



GB Nylon line hardened
DE Mähfaden für Rasentrimmer Gestärkt
RU Леска на катушке для триммера силенный
CZ Struna do strunové sekačky
SK Struna do strunové kosačky
HU Damil szegélynyíró géphez
RO Furtun gradina

John Gardener Kod produktu **Żyłka do podkaszarki zbrojona (okrągła) 2,4mmx100m G73940 24**
Żyłka do podkaszarki zbrojona (okrągła) 2,7mmx100m G73943 20
Żyłka do podkaszarki zbrojona (okrągła) 3,0mmx100m G73946 12

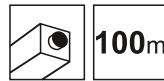

GB Nylon line hardened
DE Mähfaden für Rasentrimmer Gestärkt
RU Леска на катушке для триммера силенный
CZ Struna do strunové sekačky
SK Struna do strunové kosačky
HU Damil szegélynyíró géphez
RO Furtun gradina

John Gardener Kod produktu **Żyłka do podkaszarki zbrojona (kwadrat) 2,4mmx100m G73941 24**
Żyłka do podkaszarki zbrojona (kwadrat) 2,7mmx100m G73944 20
Żyłka do podkaszarki zbrojona (kwadrat) 3,0mmx100m G73947 8



GB Nylon line hardened
DE Mähfaden für Rasentrimmer Gestärkt
RU Леска на катушке для триммера силенный
CZ Struna do strunové sekačky
SK Struna do strunové kosačky
HU Damil szegélynyíró géphez
RO Furtun gradina

John Gardener Kod produktu **Żyłka do podkaszarki zbrojona(gwiazdka) 2,4mmx100 G73942 24**
Żyłka do podkaszarki zbrojona(gwiazdka) 2,7mmx100 G73945 24
Żyłka do podkaszarki zbrojona(gwiazdka) 3,0mmx100 G73948 20



GB Nylon line hardened
DE Mähfaden für Rasentrimmer Gestärkt
RU Леска на катушке для триммера силенный
CZ Struna do strunové sekačky
SK Struna do strunové kosačky
HU Damil szegélynyíró géphez
RO Furtun gradina

John Gardener Kod produktu **Żyłka do podkaszarki okrągła 2.0mmx1LB (126m) G73950 24**
Żyłka do podkaszarki okrągła 2.4mmx1LB (88m) G73951 24
Żyłka do podkaszarki okrągła 3.0mmx1LB (56m) G73952 24



GB Nylon line hardened
DE Mähfaden für Rasentrimmer Gestärkt
RU Леска на катушке для триммера силеный
CZ Struna do strunové sekačky
SK Struna do strunové kosačky
HU Damil szegélynyíró géphez
RO Furtun gradina

John Gardener	Kod produktu	
Żyłka do podkaszarki karbowana 2,0mmx1LB (175m)	G73953	24
Żyłka do podkaszarki karbowana 2,4mmx1LB (122m)	G73954	24
Żyłka do podkaszarki karbowana 3,0mmx1LB (78m)	G73955	24

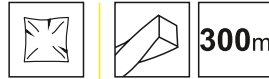

GB Nylon line hardened
DE Mähfaden für Rasentrimmer Gestärkt
RU Леска на катушке для триммера силеный
CZ Struna do strunové sekačky
SK Struna do strunové kosačky
HU Damil szegélynyíró géphez
RO Furtun gradina

John Gardener	Kod produktu	
Żyłka do podkaszarki karbowana 2,7mmx300m	G73957	8
Żyłka do podkaszarki karbowana 2,4mmx300m	G73958	8
Żyłka do podkaszarki karbowana 2,0mmx300m	G73959	8



GB Nylon line hardened
DE Mähfaden für Rasentrimmer Gestärkt
RU Леска на катушке для триммера силеный
CZ Struna do strunové sekačky
SK Struna do strunové kosačky
HU Damil szegélynyíró géphez
RO Furtun gradina

John Gardener	Kod produktu	
Żyłka do podkaszarki zbrojona(okrągła) 1,3mmx15m	G73960-4	120
Żyłka do podkaszarki zbrojona(okrągła) 1,6mmx15m	G73960-3	120
Żyłka do podkaszarki zbrojona(okrągła) 2,0mmx15m	G73960-2	120
Żyłka do podkaszarki zbrojona(okrągła) 2,4mmx15m	G73962	120
Żyłka do podkaszarki zbrojona(okrągła) 2,7mmx15m	G73960-1	80
Żyłka do podkaszarki zbrojona(okrągła) 3,0mmx15m	G73960	80

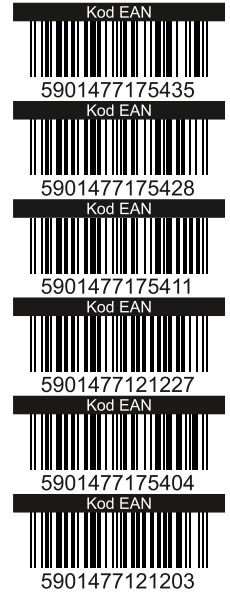
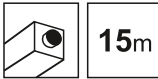

GB Nylon line hardened
DE Mähfaden für Rasentrimmer Gestärkt
RU Леска на катушке для триммера силеный
CZ Struna do strunové sekačky
SK Struna do strunové kosačky
HU Damil szegélynyíró géphez
RO Furtun gradina

John Gardener	Kod produktu	
Żyłka do podkaszarki zbrojona(kwadrat) 1,3mmx15m	G73964-4	120
Żyłka do podkaszarki zbrojona(kwadrat) 1,6mmx15m	G73964-3	120
Żyłka do podkaszarki zbrojona(kwadrat) 2,0mmx15m	G73964-2	120
Żyłka do podkaszarki zbrojona (kwadrat) 2,4mmx15m	G73966	80
Żyłka do podkaszarki zbrojona(kwadrat) 2,7mmx15m	G73964-1	80
Żyłka do podkaszarki zbrojona(kwadrat) 3,0mmx15m	G73964	80

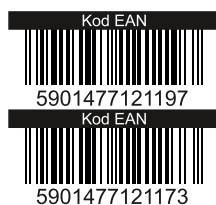

GB Nylon line hardened
DE Mähfaden für Rasentrimmer Gestärkt
RU Леска на катушке для триммера силеный
CZ Struna do strunové sekačky
SK Struna do strunové kosačky
HU Damil szegélynyíró géphez
RO Furtun gradina

John Gardener	Kod produktu	
Żyłka do podkaszarki zbrojona (okrągła) 2,4mmx50m	G73963	40
Żyłka do podkaszarki zbrojona (okrągła) 3,0mmx50m	G73961	20

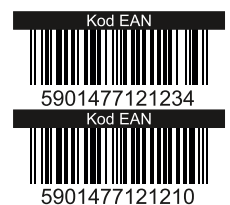

GB Nylon line hardened
DE Mähfaden für Rasentrimmer Gestärkt
RU Леска на катушке для триммера силеный
CZ Struna do strunové sekačky
SK Struna do strunové kosačky
HU Damil szegélynyíró géphez
RO Furtun gradina

John Gardener	Kod produktu	
Żyłka do podkaszarki zbrojona (kwadrat) 2,4mmx50m	G73967	20
Żyłka do podkaszarki zbrojona (kwadrat) 3,0mmx50m	G73965	20



Kod EAN
5901477175459
Kod EAN
5901477121265
Kod EAN
5901477175442
Kod EAN
5901477121241

GB Nylon line hardened
DE Mähfaden für Rasentrimmer Gestärkt
RU Леска на катушке для триммера силенный
CZ Struna do strunové sekačky
SK Struna do strunové kosačky
HU Damil szegélynyíró géphez
RO Furtun gradina

John Gardener	Kod produktu	
Żyłka do podkaszarki zbrojona(karbowana)2,0mmx15	G73968-2	120
Żyłka do podkaszarki zbrojona(karbowana)2,4mmx15	G73970	80
Żyłka do podkaszarki zbrojona(karbowana)2,7mmx15	G73968-1	80
Żyłka do podkaszarki zbrojona(karbowana)3,0mmx15	G73968	80



Kod EAN
5901477121272
Kod EAN
5901477121258

GB Nylon line hardened
DE Mähfaden für Rasentrimmer Gestärkt
RU Леска на катушке для триммера силенный
CZ Struna do strunové sekačky
SK Struna do strunové kosačky
HU Damil szegélynyíró géphez
RO Furtun gradina

John Gardener	Kod produktu	
Żyłka do podkaszarki zbrojona(karbowana)2,4mmx50	G73971	40
Żyłka do podkaszarki zbrojona(karbowana)3,0mmx50	G73969	20



Kod EAN
5901477116773
Kod EAN
5901477121296

GB Nylon line hardened
DE Mähfaden für Rasentrimmer Gestärkt
RU Леска на катушке для триммера силенный
CZ Struna do strunové sekačky
SK Struna do strunové kosačky
HU Damil szegélynyíró géphez
RO Furtun gradina

John Gardener	Kod produktu	
Żyłka do podkaszarki pięciokąt 2,4mmx30m	G73981	80
Żyłka do podkaszarki pięciokąt 3,0mmx30m	G73978	40



Kod EAN
5901477123696
Kod EAN
5901477121302

GB Nylon line hardened
DE Mähfaden für Rasentrimmer Gestärkt
RU Леска на катушке для триммера силенный
CZ Struna do strunové sekačky
SK Struna do strunové kosačky
HU Damil szegélynyíró géphez
RO Furtun gradina

John Gardener	Kod produktu	
Żyłka do podkaszarki pięciokąt 2,4mmx100m	G73983	24
Żyłka do podkaszarki pięciokąt 3,0mmx100m	G73979	20



GB Nylon line hardened
DE Mähfaden für Rasentrimmer Gestärkt
RU Леска на катушке для триммера силенный
CZ Struna do strunové sekačky
SK Struna do strunové kosačky
HU Damil szegélynyíró géphez
RO Furtun gradina

Kod EAN
5901477116766

John Gardener	Kod produktu	
Żyłka do podkaszarki pięciokąt 2,4mmx10m	G73980	120

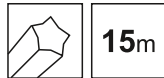

GB Nylon line hardened
DE Mähfaden für Rasentrimmer Gestärkt
RU Леска на катушке для триммера силенный
CZ Struna do strunové sekačky
SK Struna do strunové kosačky
HU Damil szegélynyíró géphez
RO Furtun gradina

Kod EAN
5901477175473
Kod EAN
5901477175466
Kod EAN
5901477121289

John Gardener	Kod produktu	
Żyłka do podkaszarki pięciokąt 2,0mmx15m	G73977-2	120
Żyłka do podkaszarki pięciokąt 2,7mmx15m	G73977-1	80
Żyłka do podkaszarki pięciokąt 3,0mmx15m	G73977	80



GB Nylon line hardened
DE Mähfaden für Rasentrimmer Gestärkt
RU Леска на катушке для триммера силенный
CZ Struna do strunové sekačky
SK Struna do strunové kosačky
HU Damil szegélynyíró géphez
RO Furtun gradina

Kod EAN
5901477116780

John Gardener	Kod produktu	
Żyłka do podkaszarki sześciokąt 2,4mmx10m	G73985	120



GB Nylon line hardened
DE Mähfaden für Rasentrimmer Gestärkt
RU Леска на катушке для триммера силенный
CZ Struna do strunové sekačky
SK Struna do strunové kosačky
HU Damil szegélynyíró géphez
RO Furtun gradina

Kod EAN
5901477116797

John Gardener	Kod produktu	
Żyłka do podkaszarki sześciokąt 2,4mmx30m	G73986	80



GB Nylon line hardened
DE Mähfaden für Rasentrimmer Gestärkt
RU Леска на катушке для триммера силенный
CZ Struna do strunové sekačky
SK Struna do strunové kosačky
HU Damil szegélynyíró géphez
RO Furtun gradina

Kod EAN
5901477116827

John Gardener	Kod produktu	
Żyłka do podkaszarki sześciokąt 2,4mmx50m	G73987	40



GB Nylon line hardened
DE Mähfaden für Rasentrimmer Gestärkt
RU Леска на катушке для триммера силенный
CZ Struna do strunové sekačky
SK Struna do strunové kosačky
HU Damil szegélynyíró géphez
RO Furtun gradina

Kod EAN
5901477123702

John Gardener	Kod produktu	
Żyłka do podkaszarki sześciokąt 2,4mmx100m	G73984	24



15m



GB Nylon line hardened
DE Mähfaden für Rasentrimmer Gestärkt
RU Леска на катушке для триммера силенный
CZ Struna do strunové sekačky
SK Struna do strunové kosačky
HU Damil szegélynyíró géphez
RO Furtun gradina



John Gardener	Kod produktu	
Żyłka do podkaszarki sześciokąt 2,0mmx15m	G73988-2	120
Żyłka do podkaszarki sześciokąt 2,7mmx15m	G73988-1	80



10m

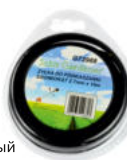

GB Nylon line hardened
DE Mähfaden für Rasentrimmer Gestärkt
RU Леска на катушке для триммера силенный
CZ Struna do strunové sekačky
SK Struna do strunové kosačky
HU Damil szegélynyíró géphez
RO Furtun gradina



John Gardener	Kod produktu	
Żyłka do podkaszarki siedmiokąt 2,7mmx10m	G73988	120



30m



GB Nylon line hardened
DE Mähfaden für Rasentrimmer Gestärkt
RU Леска на катушке для триммера силенный
CZ Struna do strunové sekačky
SK Struna do strunové kosačky
HU Damil szegélynyíró géphez
RO Furtun gradina



John Gardener	Kod produktu	
Żyłka do podkaszarki siedmiokąt 2,7mmx30m	G73989	40



100m



GB Nylon line hardened
DE Mähfaden für Rasentrimmer Gestärkt
RU Леска на катушке для триммера силенный
CZ Struna do strunové sekačky
SK Struna do strunové kosačky
HU Damil szegélynyíró géphez
RO Furtun gradina



John Gardener	Kod produktu	
Żyłka do podkaszarki siedmiokąt 2,7mmx100m	G73990	24



10m



GB Nylon line hardened
DE Mähfaden für Rasentrimmer Gestärkt
RU Леска на катушке для триммера силенный
CZ Struna do strunové sekačky
SK Struna do strunové kosačky
HU Damil szegélynyíró géphez
RO Furtun gradina



John Gardener	Kod produktu	
Żyłka do podkaszarki okrągła 2,4mmx10m	G73995-2	240
Żyłka do podkaszarki okrągła 2,7mmx10m	G73995-1	200



12m



GB Nylon line hardened
DE Mähfaden für Rasentrimmer Gestärkt
RU Леска на катушке для триммера силенный
CZ Struna do strunové sekačky
SK Struna do strunové kosačky
HU Damil szegélynyíró géphez
RO Furtun gradina



John Gardener	Kod produktu	
Żyłka do podkaszarki okrągła 3mmx12m	G73995	80



15m



GB Nylon line hardened
DE Mähfaden für Rasentrimmer Gestärkt
RU Леска на катушке для триммера силенный
CZ Struna do strunové sekačky
SK Struna do strunové kosačky
HU Damil szegélynyíró géphez
RO Furtun gradina



John Gardener	Kod produktu	
Żyłka do podkaszarki okrągła 1,3mmx15m	G73999	120
Żyłka do podkaszarki okrągła 1,6mmx15m	G73991	240
Żyłka do podkaszarki okrągła 2,0mmx15m	G73993	192



15m



GB Nylon line hardened
DE Mähfaden für Rasentrimmer Gestärkt
RU Леска на катушке для триммера силенный
CZ Struna do strunové sekačky
SK Struna do strunové kosačky
HU Damil szegélynyíró géphez
RO Furtun gradina



John Gardener	Kod produktu	
Żyłka do podkaszarki karbowana 2,4mmx15m	G73996	80



100m



GB Nylon line hardened
DE Mähfaden für Rasentrimmer Gestärkt
RU Леска на катушке для триммера силенный
CZ Struna do strunové sekačky
SK Struna do strunové kosačky
HU Damil szegélynyíró géphez
RO Furtun gradina



John Gardener	Kod produktu	
Żyłka do podkaszarki karbowana 2,4mmx100m	G73997	24



10m



GB Nylon line hardened
DE Mähfaden für Rasentrimmer Gestärkt
RU Леска на катушке для триммера силенный
CZ Struna do strunové sekačky
SK Struna do strunové kosačky
HU Damil szegélynyíró géphez
RO Furtun gradina



John Gardener	Kod produktu	
Żyłka do podkaszarki kwadrat 1,3mmx10m	G73998-5	288
Żyłka do podkaszarki kwadrat 1,6mmx10m	G73998-4	240
Żyłka do podkaszarki kwadrat 2,0mmx10m	G73998-3	240
Żyłka do podkaszarki kwadrat 2,4mmx10m	G73998-2	240
Żyłka do podkaszarki kwadrat 2,7mmx10m	G73998-1	200
Żyłka do podkaszarki kwadrat 3,0mmx10m	G73998	144

Aeratory i wertykulatory / Aerators



208cc	max ⚡ 6.5KM
↔ 400mm	-15/-10/ 0 /+10/+15 mm
 3600 ml	 50 l



GB Scarifier
DE Vertikutierer
RU Аэратор-скарификатор
CZ Vertikutátor
SK Vertikutátor
HU Irtóborona
RO Scarificator



Kod EAN
5903418304324

John Gardener
#Aerator Wertykulator spalinowy 6.5HP (2 wałki) Kod produktu G84015 1



196cc	max ⚡ 6.5KM
↔ 400mm	↑ 5mm ↓ 15mm
 2500 ml	 40 l



GB Scarifier
DE Vertikutierer
RU Аэратор-скарификатор
CZ Vertikutátor
SK Vertikutátor
HU Irtóborona
RO Scarificator



Kod EAN
5901477138294

John Gardener
#Aerator spalinowy 40cm 6,5HP Kod produktu G84005 1

 230V-50Hz	 45 l
↔ 380mm	



GB Scarifier
DE Vertikutierer
RU Аэратор-скарификатор
CZ Vertikutátor
SK Vertikutátor
HU Irtóborona
RO Scarificator



Kod EAN
5901477150142

John Gardener
Aerator wertykulator 2w1 JG PREMIUM Kod produktu G83002 1

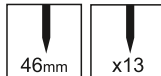
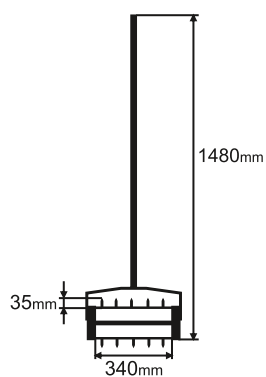

GB Scarifier
DE Vertikutierer
RU Аэратор-скарификатор
CZ Vertikutátor
SK Vertikutátor
HU Irtóborona
RO Scarificator



Kod EAN
5901477176159

John Gardener Kod produktu 4
Aerator walcowy do trawy G72069 4



GB Scarifier
DE Vertikutierer
RU Аэратор-скарификатор
CZ Vertikutátor
SK Vertikutátor
HU Irtóborona
RO Scarificator



Kod EAN
5901477134388

John Gardener Kod produktu 10
Aerator sandalowy na buty z kolcami G72070 10

Glebogryzarki / Cultivators

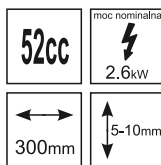
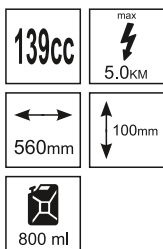

GB Tiller
DE Kultivator
RU Культиватор
CZ Kultivátor
SK Kultivátor
HU Kultivátor
RO Cultivator



Kod EAN
5901477137044



John Gardener Kod produktu 1
#Glebogryzarka spalinowa 5.0HP 56cm G84001 1

GB Tiller
DE Kultivator
RU Культиватор
CZ Kultivátor
SK Kultivátor
HU Kultivátor
RO Cultivator



Kod EAN
5901477186615

John Gardener Kod produktu 1
Glebogryzarka spalinowa 30cm G84008 1

212cc  5.5kw
 50-100mm  10-30mm





GB Tiller
 DE Kultivator
 RU Культиватор
 CZ Kultivátor
 SK Kultivátor
 HU Kultivátor
 RO Cultivator

Kod EAN

 5903418304331

John Gardener Kod produktu 
#Glebogryzarka spalinowa 212cc FULL SET G84016 1

52cc  1.4kw
 280mm  5-10mm





GB Tiller
 DE Kultivator
 RU Культиватор
 CZ Kultivátor
 SK Kultivátor
 HU Kultivátor
 RO Cultivator

Kod EAN

 5901477186622

John Gardener Kod produktu 
Glebogryzarka spalinowa 28cm G84009 1

 230V-50Hz  280obr/min
 450mm  220mm





GB Electric tiller
 DE Elektrische kultivator
 RU Электрический культиватор
 CZ Elektrický kultivátor
 SK Elektrický kultivátor
 HU Elektromos kultivátor
 RO Cultivator electric

Kod EAN

 5901477129124

John Gardener Kod produktu 
Elektryczna glebogryzarka-kultywator 45cm G83003 1

 230V-50Hz  380obr/min
 320mm  200mm



GB Electric tiller
 DE Elektrische kultivator
 RU Электрический культиватор
 CZ Elektrický kultivátor
 SK Elektrický kultivátor
 HU Elektromos kultivátor
 RO Cultivator electric

Kod EAN

 5901477124501

John Gardener Kod produktu 
Elektryczna glebogryzarka-kultywator 32cm G83004 1



GB Hand cultivator with handle
 DE Handkultivator, eingefasst
 RU Культиватор ручной садовый
 CZ Ruční kultivátor s násadou
 SK Ručné kultivátor s násadou
 HU Kézi kultivátor, nyeles
 RO Cultivator cu maner

Kod EAN

 5903418302399

John Gardener Kod produktu 
Kultywator ręczny - spulchniacz gleby TWIST G72076 6

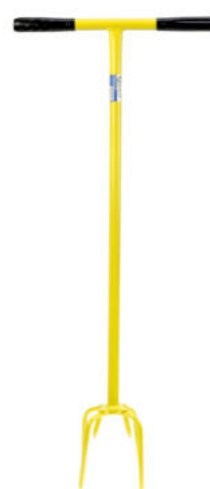

GB Hand cultivator with handle
 DE Handkultivator, eingefasst
 RU Культиватор ручной садовый
 CZ Ruční kultivátor s násadou
 SK Ručné kultivátor s násadou
 HU Kézi kultivátor, nyeles
 RO Cultivator cu maner

Kod EAN

 5901477161346

John Gardener Kod produktu 
Kultywator ręczny - spulchniacz gleby G72075 12

Dmuchawy/odkurzacze ogrodowe

/ Leaf Blowers & Garden Vacuums



25.4cc	max 1.0kW
800 ml	30 : 1
MAX 7500/min	45L



42.7cc	max nominalna 1.25kW
1200 ml	MAX 7000/min



GB Vacuum cleaner - Leaf blower
 DE Staubsauger - Laubbläser
 RU Садовый пылесос
 CZ Motorový fukár
 SK Motorový fukár
 HU Lombszívó, lombfúvó
 RO Aspirator - Suflanta frunzelor



Kod EAN
5901477136023

John Gardener
 Odkurzacz-dmuchawa spalinowa do liści JG
 Kod produktu
G84010 1



GB Vacuum cleaner - Leaf blower
 DE Staubsauger - Laubbläser
 RU Садовый пылесос
 CZ Motorový fukár
 SK Motorový fukár
 HU Lombszívó, lombfúvó
 RO Aspirator - Suflanta frunzelor



Kod EAN
5901477156892

John Gardener
 Dmuchawa spalinowa do liści JG Strong
 Kod produktu
G84011 1

 230V~50Hz	 max 3000W
 MAX 14000/min	45L
IP20	regulacja obrotów



GB Vacuum leaf blower
DE Vakuum-Laubgebläse
RU Вакуум листьев воздуходувки
CZ Elektrický vysavač/foukač
SK Elektrický vysávač / fúkač
HU Lombszívó / lombfúvó
RO Aspirator / suflantă frunze

Kod EAN

5901477127335

John Gardener Kod produktu 
Odkurzacz-dmuchawa do liści 3-funkcyjny Standard G81070 1

 230V~50Hz	 max 3300W
 MAX 1400/min	45L
IP20	regulacja obrotów







GB Vacuum leaf blower
DE Vakuum-Laubgebläse
RU Вакуум листьев воздуходувки
CZ Elektrický vysavač/foukač
SK Elektrický vysávač / fúkač
HU Lombszívó / lombfúvó
RO Aspirator / suflantă frunze

Kod EAN

5901477127427

John Gardener Kod produktu 
Odkurzacz-dmuchawa do liści 3-funcyjny BIG G81071 1

25.4cc	 max 1.0km
 700 ml	 25 : 1
 MAX 7500/min	





GB Gasoline blower
DE Benzengebläse
RU Бензиновый вентилятор
CZ Benzínový dmychadlo
SK Benzínový dúchadlo
HU Benzinfúvó
RO Suflanta pe benzina

Kod EAN

5901477187889

John Gardener Kod produktu 
Dmuchała spalínowa do liści JG G84012 4





 260km/h	 2x21V
	



GB Cordless leaf blower
DE Akku-Laubbläser
RU Аккумуляторная воздуходувка для листьев
CZ Akumulátorový foukač listí
SK Akumulátorový fúkač listia
HU Akkumulátoros lombfúvó
RO Suflantă cu acumulator pentru frunze

Kod EAN

5903418303082

 Kod produktu 
Dmuchała akumulátorowa do liści 2x2.0Ah 21V G80661 6

Piły, pilarki / Chain Saws



43cc	moc nominalna ⚡ 2.3KM
max 40cm	18"
520 ml	25 : 1



55cc	moc nominalna ⚡ 2.3KM
max 50cm	20"
520 ml	25 : 1



GB Gasoline chainsaw
DE Motorsägen
RU Бензопила
CZ Motorová pila
SK Motorová pila
HU Benzin láncfűrész
RO Drujba pe benzina



5901477127588

John Gardener
Piła spalinowa łańcuchowa Standard 4500 18" G82001 1

GB Gasoline chainsaw
DE Motorsägen
RU Бензопила
CZ Motorová pila
SK Motorová pila
HU Benzin láncfűrész
RO Drujba pe benzina



5901477127595

John Gardener
Piła spalinowa łańcuchowa BIG 5800 20" G82002 1

25.4cc	moc nominalna ⚡ 1.5KM
max 25cm	10"
230 ml	25 : 1



GB Gasoline chainsaw
DE Motorsägen
RU Бензопила
CZ Motorová pila
SK Motorová pila
HU Benzin láncfűrész
RO Drujba pe benzina



5901477120657

John Gardener
Piła spalinowa do gałęzi German 2500 G82005 1

230V-50Hz	max ⚡ 710W
max 18cm	0.2 L
229-289 cm	



GB Electrical branch chainsaw
DE Astkettensäge
RU Электрический высотерез
CZ Řetězová vuvětrovací pila
SK Odvetovacia motorová pila
HU Motoros ágvágó fűrész
RO Fierastrau electric telescopic pentru taiat crengi



5901477151149

John Gardener
Piła elektryczna łańcuchowa do gałęzi na wysięgniku G83008 1

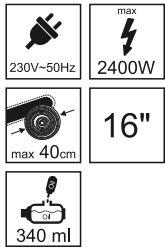

GB Electrical branch chainsaw
DE Astkettensäge
RU Электрический высторез
CZ Řetězová uuvětvoovací pila
SK Odvetovacia motorová pila
HU Motoros ágváágó fűrész
RO Fierastrau electric telescopic pentru taiat crengi



John Gardener Kod produktu 2
Pila elektryczna łańcuchowa (side engine) 2400W G82007 2

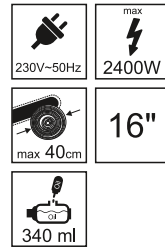

GB Electrical branch chainsaw
DE Astkettensäge
RU Электрический высторез
CZ Řetězová uuvětvoovací pila
SK Odvetovacia motorová pila
HU Motoros ágváágó fűrész
RO Fierastrau electric telescopic pentru taiat crengi



John Gardener Kod produktu 2
Pila elektryczna łańcuchowa (straight engine) 2400W G82008 2

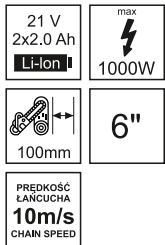

GB Cordless chainsaw
DE Kabellose Kettensäge
RU Аккумуляторная бензопила
CZ Akumulátorová řetězová pila
SK Akumulátorová řetězová pila
HU Akkus láncfűrész
RO Ferăstrău cu lanț fără fir



John Gardener Kod produktu 10
Pila łańcuchowa akumulatorowa 6" w walizce 2x2.0Ah 21V G80665 10



zestaw XXL
z wysięgnikiem teleskopowym
1.65-2.50m



GB Cordless chainsaw
DE Kabellose Kettensäge
RU Аккумуляторная бензопила
CZ Akumulátorová řetězová pila
SK Akumulátorová řetězová pila
HU Akkus láncfűrész
RO Ferăstrău cu lanț fără fir



John Gardener Kod produktu 10
Pila łańcuchowa akumulatorowa 6" w walizce 2x2.0Ah 21V G80666 10



GB Telescopic extension pole for saws and pruners
DE Teleskopstange für Sägen und Scheren
RU Телескопическая штанга для пил и секаторов
CZ Teleskopický nástavec pro pily a nožnice
SK Teleskopický nástavec pre pily a nožnice
HU Teleszkópos hosszabbító fűrészekhez és metszőollókhöz
RO Braț telescopic pentru fierăstraie și foarfeci



John Gardener Kod produktu 6
Wysięgnik teleskopowy do pил i sektorów akumulatorowych G80664 6

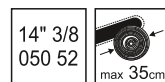

GB Chainsaw guide bar
DE Kettensägeführung
RU Шина для бензопил
CZ Vodičá lišta k řetězové pile
SK Vodičá lišta k řetázovej pile
HU Láncvezető
RO Lama de ghidai pt. ferastrau



John Gardener Kod produktu 20
Prowadnica 14" 3/8,050 52 do Partnera G74000 20

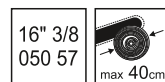

GB Chainsaw guide bar
DE Kettensägeführung
RU Шина для бензопил
CZ Vodičá lišta k řetězové pile
SK Vodičá lišta k řetázovej pile
HU Láncvezető
RO Lama de ghidai pt. ferastrau



John Gardener Kod produktu 20
Prowadnica 16" 3/8,050 57 do Partnera G74001 20

15" 325
058 64
max 38cm



GB Chainsaw guide bar
DE Kettensägeführung
RU Шина для бензопил
CZ Vodičí lišta k řetězové pile
SK Vodiaca lišta k reťazovej pile
HU Láncevezető
RO Lama de ghidai pt. ferastrau

Kod EAN
5901477112959

John Gardener
Kod produktu
Prowadnica 15"325,058 64 do Husqvarny G74002 20

14" 3/8
050 50
max 35cm



GB Chainsaw guide bar
DE Kettensägeführung
RU Шина для бензопил
CZ Vodičí lišta k řetězové pile
SK Vodiaca lišta k reťazovej pile
HU Láncevezető
RO Lama de ghidai pt. ferastrau

Kod EAN
5901477112966

John Gardener
Kod produktu
Prowadnica 14"3/8,050 50 do Sthila G74003 20

10"
max 25cm



GB Chainsaw guide bar
DE Kettensägeführung
RU Шина для бензопил
CZ Vodičí lišta k řetězové pile
SK Vodiaca lišta k reťazovej pile
HU Láncevezető
RO Lama de ghidai pt. ferastrau

Kod EAN
5901477132001

John Gardener
Kod produktu
Prowadnica do pily G82005 German 10" G74006 20

18" 325
1,5mm
max 45cm



GB Chainsaw guide bar
DE Kettensägeführung
RU Шина для бензопил
CZ Vodičí lišta k řetězové pile
SK Vodiaca lišta k reťazovej pile
HU Láncevezető
RO Lama de ghidai pt. ferastrau

Kod EAN
5901477135927

John Gardener
Kod produktu
Prowadnica do pily G82001 ,18" 325 1,5mm G74008 25

22" 325
1,5mm
max 48cm



GB Chainsaw guide bar
DE Kettensägeführung
RU Шина для бензопил
CZ Vodičí lišta k řetězové pile
SK Vodiaca lišta k reťazovej pile
HU Láncevezető
RO Lama de ghidai pt. ferastrau

Kod EAN
5901477132018

John Gardener
Kod produktu
Prowadnica do pily G82002 BIG 22" 325 1,5mm G74009 20

15" 325
058 64
max 38cm



GB Guide bar + 2x chain
DE Führungsschiene + 2x die Kette zu den Sägen
RU Шина для цепи для электропилы + 2x цепь к пилам
CZ Lišta vodičí + 2x řetěz
SK Lišta vodiace + 2x reťaz
HU Láncevezető + 2db lánc
RO Lama de ghidai pt. ferastrau + 2 Lant pt. drujba

Kod EAN
5901477117411

John Gardener
Kod produktu
Prowadnica 15"325 + 2xłańcuch 058 64 do Husqvarny G74010 20

14" 3/8
050 50
max 35cm



GB Guide bar + 2x chain
DE Führungsschiene + 2x die Kette zu den Sägen
RU Шина для цепи для электропилы + 2x цепь к пилам
CZ Lišta vodičí + 2x řetěz
SK Lišta vodiace + 2x reťaz
HU Láncevezető + 2db lánc
RO Lama de ghidai pt. ferastrau + 2 Lant pt. drujba

Kod EAN
5901477117428

John Gardener
Kod produktu
Prowadnica 14"3/8+ 2xłańcuch 050 50 do Stihla G74011 20

14" 3/8
050 52
max 35cm





GB Guide bar + 2x chain
DE Führungsschiene + 2x die Kette zu den Sägen
RU Шина для цепи для электропилы + 2x цепь к пилам
CZ Lišta vodičí + 2x řetěz
SK Lišta vodiace + 2x reťaz
HU Láncevezető + 2db lánc
RO Lama de ghidai pt. ferastrau + 2 Lant pt. drujba

Kod EAN
5901477117435

John Gardener
Kod produktu
Prowadnica 14"3/8+ 2xłańcuch 050 52 do Partnera G74012 20

3.8"
1.3mm

GB Drive links for chains
DE Antriebs Links für Ketten
RU Приводных звеньев для цепей
CZ Spojky a nůty řetězu
SK Spojky a nity reťazu
HU Lánckarbantartás
RO Nituri lant drujba

Kod EAN
5901477123467

John Gardener
Kod produktu
Spinki do łańcucha do pil 3,8" 1,3mm G74018 5000

325"
1.5mm





GB Drive links for chains
DE Antriebs Links für Ketten
RU Приводных звеньев для цепей
CZ Spojky a nůty řetězu
SK Spojky a nity reťazu
HU Lánckarbantartás
RO Nituri lant drujba

Kod EAN
5901477123481

John Gardener
Kod produktu
Spinki do łańcucha do pil 325"1,5mm G74019 5000

18" 325
1.5mm
050 72T





GB Chain for chainsaw
DE Kette für Kettensägen
RU Цепь для бензопилы
CZ Řetěz pro řetězové pily
SK Reťaz pre reťazové pily
HU Lánclánzfűrés
RO Lant pt. drujba

Kod EAN
5901477135934

John Gardener
Kod produktu
Łańcuch do pily G82001 Standard 18" 325 1.5mm 050 G74026 100

20" 3/8
1.5mm
058 76T





GB Chain for chainsaw
DE Kette für Kettensägen
RU Цепь для бензопилы
CZ Řetěz pro řetězové pily
SK Reťaz pre reťazové pily
HU Lánclánzfűrés
RO Lant pt. drujba

Kod EAN
5901477143380

John Gardener
Kod produktu
Łańcuch do pily G82002 BIG 20" 3/8" 1.5mm 058 G74027 100

10" 3/8
050 40T

GB Chain for chainsaw
DE Kette für Kettensägen
RU Цепь для бензопилы
CZ Řetěz pro řetězové pily
SK Retaz pre retazové pily
HU Láncláncfűrészt
RO Lant pt. drujba

Kod EAN
5901477143397

John Gardener Kod produktu
Łańcuch do pily G82005 German 10" 3/8 050 G74028 100

14" 3/8"
050 52T





GB Chain for chainsaw
DE Kette für Kettensägen
RU Цепь для бензопилы
CZ Řetěz pro řetězové pily
SK Retaz pre retazové pily
HU Láncláncfűrészt
RO Lant pt. drujba

Kod EAN
5901477113093

John Gardener Kod produktu
Łańcuch 3/8"050 52T do Partnera 14" G74030 100

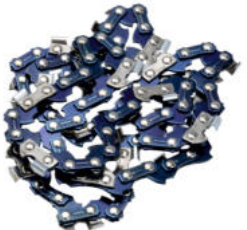
16" 3/8"
050 56T

GB Chain for chainsaw
DE Kette für Kettensägen
RU Цепь для бензопилы
CZ Řetěz pro řetězové pily
SK Retaz pre retazové pily
HU Láncláncfűrészt
RO Lant pt. drujba

Kod EAN
5901477112911

John Gardener Kod produktu
Łańcuch 3/8"050 56T do Partnera 16" G74040 100

14" 3/8"
050 50T



GB Chain for chainsaw
DE Kette für Kettensägen
RU Цепь для бензопилы
CZ Řetěz pro řetězové pily
SK Retaz pre retazové pily
HU Láncláncfűrészt
RO Lant pt. drujba

Kod EAN
5901477113154

John Gardener Kod produktu
Łańcuch 3/8" 050 50T do Stihla 14" G74050 100

16" 3/8"
050 55T





GB Chain for chainsaw
DE Kette für Kettensägen
RU Цепь для бензопилы
CZ Řetěz pro řetězové pily
SK Retaz pre retazové pily
HU Láncláncfűrészt
RO Lant pt. drujba

Kod EAN
5901477112928

John Gardener Kod produktu
Łańcuch 3/8" 050 55T do Stihla 16" G74060 100

16" 3/8
063 60T





GB Chain for chainsaw
DE Kette für Kettensägen
RU Цепь для бензопилы
CZ Řetěz pro řetězové pily
SK Retaz pre retazové pily
HU Láncláncfűrészt
RO Lant pt. drujba

Kod EAN
5901477116551

John Gardener Kod produktu
Łańcuch 3/8 063 60T do Stihla 16" G74070 50

15" 325
058 64T

GB Chain for chainsaw
DE Kette für Kettensägen
RU Цепь для бензопилы
CZ Řetěz pro řetězové pily
SK Retaz pre retazové pily
HU Láncláncfűrészt
RO Lant pt. drujba

Kod EAN
5901477112935

John Gardener Kod produktu
Łańcuch 325 058 64T do Husquarny 15" G74080 100

18" 325
058 72T



GB Chain for chainsaw
DE Kette für Kettensägen
RU Цепь для бензопилы
CZ Řetěz pro řetězové pily
SK Retaz pre retazové pily
HU Láncláncfűrészt
RO Lant pt. drujba

Kod EAN
5901477112942

John Gardener Kod produktu
Łańcuch 325 058 72T do Husquarny 18" G74090 100

14" 3/8
050 52



GB Chainsaw guide bar
DE Kettensägeführung
RU Шина для бензопилы
CZ Vodičí lišta k řetězové pile
SK Vodiaca lišta k retazovej pile
HU Láncevezető
RO Lama de ghidai pt. ferastrau

Kod EAN
5901477172786

John Gardener Kod produktu
Prowadnica 14"3/8,050 52 do Partnera K02400 20

16" 3/8
050 57



GB Chainsaw guide bar
DE Kettensägeführung
RU Шина для бензопилы
CZ Vodičí lišta k řetězové pile
SK Vodiaca lišta k retazovej pile
HU Láncevezető
RO Lama de ghidai pt. ferastrau

Kod EAN
5901477172793

John Gardener Kod produktu
Prowadnica 16" 3/8,050 57 do Partnera K02401 20

15" 325
058 64



GB Chainsaw guide bar
DE Kettensägeführung
RU Шина для бензопилы
CZ Vodičí lišta k řetězové pile
SK Vodiaca lišta k retazovej pile
HU Láncevezető
RO Lama de ghidai pt. ferastrau

Kod EAN
5901477172809

John Gardener Kod produktu
Prowadnica 15"325,058 64 do Husquarny K02402 20

14" 3/8
050 50



GB Chainsaw guide bar
DE Kettensägeführung
RU Шина для бензопилы
CZ Vodičí lišta k řetězové pile
SK Vodiaca lišta k retazovej pile
HU Láncevezető
RO Lama de ghidai pt. ferastrau

Kod EAN
5901477172816

John Gardener Kod produktu
Prowadnica 14"3/8,050 50 do Stihla K02403 20

15" 325
058 64



GB Guide bar + 2x chain
DE Führungsschiene + 2x die Kette zu den Sägen
RU Шина для цепи для электропилы + 2x цепь к пилам
CZ Lišta vodičí + 2x řetěz
SK Lišta vodiace + 2x reťaz
HU Láncezető + 2db lánc
RO Lama de ghidai pt. ferastrau + 2 Lant pt. drijba

Kod EAN
5901477172823

Kod produktu
Prowadnica 15"325 + 2xłańcuch 058 64 do Husqvarny K02410 20

14" 3/8"
050 50



GB Guide bar + 2x chain
DE Führungsschiene + 2x die Kette zu den Sägen
RU Шина для цепи для электропилы + 2x цепь к пилам
CZ Lišta vodičí + 2x řetěz
SK Lišta vodiace + 2x reťaz
HU Láncezető + 2db lánc
RO Lama de ghidai pt. ferastrau + 2 Lant pt. drijba

Kod EAN
5901477172830

Kod produktu
Prowadnica 14"3/8" + 2xłańcuch 050 50 do Stihla K02411 20

14" 3/8"
050 52



GB Guide bar + 2x chain
DE Führungsschiene + 2x die Kette zu den Sägen
RU Шина для цепи для электропилы + 2x цепь к пилам
CZ Lišta vodičí + 2x řetěz
SK Lišta vodiace + 2x reťaz
HU Láncezető + 2db lánc
RO Lama de ghidai pt. ferastrau + 2 Lant pt. drijba

Kod EAN
5901477172847

Kod produktu
Prowadnica 14"3/8" + 2xłańcuch 050 52 do Partnera K02412 20

14" 3/8"
050 52T



GB Chain for chainsaw
DE Kette für Kettensägen
RU Цепь для бензопилы
CZ Řetěz pro řetězové pily
SK Reťaz pre reťazové pily
HU Lánccsőrekesz
RO Lant pt. drijba

Kod EAN
5901477172854

Kod produktu
Łańcuch 3/8"050 52T do Partnera 14" K02430 100

16" 3/8"
050 56T



GB Chain for chainsaw
DE Kette für Kettensägen
RU Цепь для бензопилы
CZ Řetěz pro řetězové pily
SK Reťaz pre reťazové pily
HU Lánccsőrekesz
RO Lant pt. drijba

Kod EAN
5901477172861

Kod produktu
Łańcuch 3/8"050 56T do Partnera 16" K02440 100

14" 3/8"
050 50T



GB Chain for chainsaw
DE Kette für Kettensägen
RU Цепь для бензопилы
CZ Řetěz pro řetězové pily
SK Reťaz pre reťazové pily
HU Lánccsőrekesz
RO Lant pt. drijba

Kod EAN
5901477172878

Kod produktu
Łańcuch 3/8" 050 50T do Stihla 14" K02450 100

15" 325
058 64T



GB Chain for chainsaw
DE Kette für Kettensägen
RU Цепь для бензопилы
CZ Řetěz pro řetězové pily
SK Reťaz pre reťazové pily
HU Lánccsőrekesz
RO Lant pt. drijba

Kod EAN
5901477172908

Kod produktu
Łańcuch 325 058 64T do Husquarny 15" K02480 100

8"
x
5/32"



GB Chain saw file
DE Runde Kettenfeile
RU Новые надфили
CZ Kulatý pilník na řetězy
SK Okrúhly usilovní na reťaze
HU Lánccsőrekesz
RO Pila rotundă pt. lanțuri

Kod EAN
5901477123412

Kod produktu
Pilnik okrągły 4mm do ostrzenia łańcucha G74092 600

3/8"
x
.325"



GB Chain saw file
DE Runde Kettenfeile
RU Новые надфили
CZ Kulatý pilník na řetězy
SK Okrúhly usilovní na reťaze
HU Lánccsőrekesz
RO Pila rotundă pt. lanțuri

Kod EAN
5901477171741

Kod produktu
Pilnik okrągły 4,5mm do ostrzenia łańcucha G74093 600

8"
x
3/16"



GB Chain saw file
DE Runde Kettenfeile
RU Новые надфили
CZ Kulatý pilník na řetězy
SK Okrúhly usilovní na reťaze
HU Lánccsőrekesz
RO Pila rotundă pt. lanțuri

Kod EAN
5901477123429

Kod produktu
Pilnik okrągły 4,8mm do ostrzenia łańcucha G74094 600

do pil:
14"/16"/
18"/20"



GB Chainsaw Sharpener
DE Kettenschleifgerät
RU Настольный заточной министанок
CZ Bruska řetězu
SK Bruska reťaze
HU Fűrészláncélező
RO Masina pentru ascuțit lanțuri

Kod EAN
5901477160899

Kod produktu
Ostrzałka do łańcuchów manualna G74096 50

0.404"



GB Chain saw file
DE Runde Kettenfeile
RU Новые надфили
CZ Kulatý pilník na řetězy
SK Okrúhly usilovní na reťaze
HU Lánccsőrekesz
RO Pila rotundă pt. lanțuri

Kod EAN
5901477123436

Kod produktu
Pilnik okrągły 5,5mm do ostrzenia łańcucha G74095 600

do
G74096



GB A disc for manual chain sharpener
DE Eine Scheibe für den manuellen Kettenschärfer
RU Диск для ручной заточки цепи
CZ Kotoúč pro ruční ostříčku řetězu
SK Kotoúč na ručnú brúsku reťazi
HU Kézi láncélező tárcsa
RO Un disc pentru ascuțitorul manual de lanț

Kod EAN
5901477160714

Kod produktu
Tarcza do ostrzałki łańcuchów manualnej CG74096A 300



230V~50Hz 230W
3000-3500min
145x22,3x3x2mm

GB Chainsaw Sharpener
DE Kettenschleifgerät
RU Настольный заточной министанок
CZ Bruska řetězu
SK Brúska reťaze
HU Fűrészláncélező
RO Masina pentru ascuțit lanturi

Kod EAN
5901477142505

Kod produktu
Ostrzałka elektryczna do łańcuchów BIG PREMIUM G81021 3



GB Guide for chain saw file
DE Führung für die Kettenfeile
RU Направляющая для напильника для цепей
CZ Vedení pro pilník na řetězu
SK Vedenie pre pilník na reťaze
HU Megvezető a láncfűrészhez
RO Ghidaj pt. pila pt. lanțuri

Kod EAN
5901477159176

Kod produktu
Ostrzałka ramowa ręczna łańcuchów-prowadnik pilnika G74097 20



230V~50Hz 90W
108x23x3x2mm
5000min

GB Chainsaw Sharpener
DE Kettenschleifgerät
RU Настольный заточной министанок
CZ Bruska řetězu
SK Brúska reťaze
HU Fűrészláncélező
RO Masina pentru ascuțit lanturi

Kod EAN
5901477161476

Kod produktu
Ostrzałka do łańcuchów 90W G81207 4



230V~50Hz 220W
7500min
100x10x3x2mm

GB Chainsaw Sharpener
DE Kettenschleifgerät
RU Настольный заточной министанок
CZ Bruska řetězu
SK Brúska reťaze
HU Fűrészláncélező
RO Masina pentru ascuțit lanturi

Kod EAN
5901477115912

Kod produktu
Ostrzałka elektryczna do łańcuchów G81029 6



GB Chainsaw clutch removal wrench set
DE Kupplungswerkzeug-Satz für Motorsägen
RU Набор ключей для снятия сцепления бензопилы
CZ Sada klíčů pro demontáž spojky motorové pily
SK Sada kľúčov na demontáž spojky motorovej pily
HU Láncfűrész kuplungleszedő kulcskészlet
RO Set de chei pentru demontarea ambreiajului motoferăstrăului

Kod EAN
5903418300333

Kod produktu
Komplet kluczy do demontażu sprzęgła pily spalinowej G81143 50



GB Chain tensioner for chainsaws
DE Kettenspanner für Motorsägen
RU Натяжитель цепи для бензопилы
CZ Napínač řetězu pro motorové pily
SK Napínač reťaze pre motorové pily
HU Lánceszítő láncfűrészekhez
RO Întinzător lanț pentru motoferăstraie

Kod EAN
5901477189135

Kod produktu
Napinacz łańcucha do pilarek spalinowych G81142 500



GB Chainsaw chain breaker
DE Sägeketten Entnietgerät
RU Станок для расклепки цепей
CZ Roznitovačka pilových řetězů
SK Roznitovačka pilových reťazí
HU Szegecskinyomó fűrészláncokhoz
RO Masina spart lant drujba

Kod EAN
5901477117787

Kod produktu
Przyrząd do roznitowywania łańcuchów G74098 4



145mm 3.2mm ø22.2mm
100mm 3.2mm ø10mm
108mm 3.2mm ø22.2mm

GB Disc sharpening chains
DE Schild zu dem Schärfen Kette
RU Диск для заточки цепи
CZ Brusný kotoúč
SK Brúsny kotoúč
HU Kőszörűkő láncélező géphez korong
RO Discuri de ascuțire

Kod EAN
5901477146077
5901477125447
5901477161599

Kod produktu
Tarcza do ostrzenia łańcuchów 145x3.2x22.2 G81201B 100
Tarcza do ostrzenia łańcuchów 100x10x3.2 G81202 100
Tarcza do ostrzałki łańcuchów 108x22,2x3,2mm G81207A 100



GB Chainsaw chain spinner
DE Sägekette nietgerät
RU Станок для клепания цепей
CZ Nitovačka pilových řetězů
SK Nitovačka pilových reťazí
HU Szegecselő készülék fűrészláncokhoz
RO Masina de nituit lanturi si de spart lanturi

Kod EAN
5901477117794

Kod produktu
Przyrząd do nitowania łańcuchów G74099 4

12"  

GB Chainsaw attachment for an angle grinder
DE Kettensägenaufsatz für einen Winkelschleifer
RU Насадка для бензопилы для угловой шлифовальной
CZ Nástavec na řetězovou pilu pro úhlovou brusku
SK Nástavec na reťazovú pilu pre uhlovú brúsku
HU Lánzfűrész tartozék sarokcsiszolóhoz
RO Accesoriu de drijubă pentru un polizor unghiular

Kod EAN
5901477184864

Kod produktu 
Piła łańcuchowa 12" – przystawka do szlifierki kątownej G30124 20



GB Lubricator for saw guides
DE Schmiergerät für Sägeführungen
RU Лубризатор для направляющих пилы
CZ Maznice vodítek pil
SK Maznica pre vodiace lišty píly
HU Kenőanyag fűrészvezetőkhoz
RO Lubrificator pentru ghidaje de ferăstrău

Kod EAN
5901477180941

Kod produktu 
Smarownica do prowadnic pilarek G82009 500



GB Cylinder set
DE Zylinder + Kolben
RU Цилиндр+ поршень
CZ Válcse kompletní
SK Válcse kompletné
HU Komplet henger+ dugó gyűrű
RO Kit cilindru

Kod EAN
5901477149016

Kod produktu 
Komplet cylinder + tłok do Stihla TS410 50mm G81107 20



GB Cylinder set
DE Zylinder + Kolben
RU Цилиндр+ поршень
CZ Válcse kompletní
SK Válcse kompletné
HU Komplet henger+ dugó gyűrű
RO Kit cilindru

Kod EAN
5901477128592

Kod produktu 
Komplet cylinder + tłok do Stihla MS250 42,5mm G81108 20



GB Cylinder set
DE Zylinder + Kolben
RU Цилиндр+ поршень
CZ Válcse kompletní
SK Válcse kompletné
HU Komplet henger+ dugó gyűrű
RO Kit cilindru

Kod EAN
5901477128608

Kod produktu 
Komplet cylinder + tłok do Stihla MS260 44,7mm G81109 40

41mm 

GB Cylinder set
DE Zylinder + Kolben
RU Цилиндр+ поршень
CZ Válcse kompletní
SK Válcse kompletné
HU Komplet henger+ dugó gyűrű
RO Kit cilindru

Kod EAN
5901477128615

Kod produktu 
Komplet cylinder + tłok do Partnera 351/352/370/401 G81111 20



GB Cylinder set
DE Zylinder + Kolben
RU Цилиндр+ поршень
CZ Válcse kompletní
SK Válcse kompletné
HU Komplet henger+ dugó gyűrű
RO Kit cilindru

Kod EAN
5901477128622

Kod produktu 
Komplet cylinder + tłok do stihla 170 37mm G81112 40



GB Cylinder set
DE Zylinder + Kolben
RU Цилиндр+ поршень
CZ Válcse kompletní
SK Válcse kompletné
HU Komplet henger+ dugó gyűrű
RO Kit cilindru

Kod EAN
5901477124174

Kod produktu 
Komplet cylinder + tłok do stihla 180 38mm G81113 20



GB Cylinder set
DE Zylinder + Kolben
RU Цилиндр+ поршень
CZ Válcse kompletní
SK Válcse kompletné
HU Komplet henger+ dugó gyűrű
RO Kit cilindru

Kod EAN
5901477128639

Kod produktu 
Komplet cylinder + tłok do stihla 230 40mm G81114 20



GB Cylinder set
DE Zylinder + Kolben
RU Цилиндр+ поршень
CZ Válcse kompletní
SK Válcse kompletné
HU Komplet henger+ dugó gyűrű
RO Kit cilindru

Kod EAN
5901477149023

Kod produktu 
Komplet cylinder + tłok do Husqvarny 55 46mm G81115 20



GB Cylinder set
DE Zylinder + Kolben
RU Цилиндр+ поршень
CZ Válcse kompletní
SK Válcse kompletné
HU Komplet henger+ dugó gyűrű
RO Kit cilindru

Kod EAN
5901477149030

Kod produktu 
Komplet cylinder + tłok do Husqvarny 236/240 39mm G81116 20



GB Cylinder set
DE Zylinder + Kolben
RU Цилиндр+ поршень
CZ Válcse kompletní
SK Válcse kompletné
HU Komplet henger+ dugó gyűrű
RO Kit cilindru

Kod EAN
5901477136238

Kod produktu 
Komplet cylinder + tłok do piły spalinowej 52cc 45mm G81117 50



GB Cylinder set
DE Zylinder + Kolben
RU Цилиндр+ поршень
CZ Válcse kompletní
SK Valce kompletne
HU Komplette henger+ dugó gyűrű
RO Kit cilindru

Kod EAN
5901477136047

John Gardener Kod produktu
Komplet cylinder + tłok do Husqvarny 350 44mm G81119 20

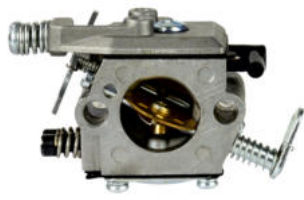

GB Carburetor
DE Vergaser
RU карбюратор
CZ Karburátor
SK Karburátor
HU Karburátor
RO Carburator

Kod EAN
5901477128653

John Gardener Kod produktu
Gaźnik do stihla MS170/MS180 G81120 100



GB Carburetor
DE Vergaser
RU карбюратор
CZ Karburátor
SK Karburátor
HU Karburátor
RO Carburator

Kod EAN
5901477128660

John Gardener Kod produktu
Gaźnik do stihla MS230/MS250 G81121 100



GB Carburetor
DE Vergaser
RU карбюратор
CZ Karburátor
SK Karburátor
HU Karburátor
RO Carburator

Kod EAN
5901477128677

John Gardener Kod produktu
Gaźnik do Partnera 350/351/370 G81122 100

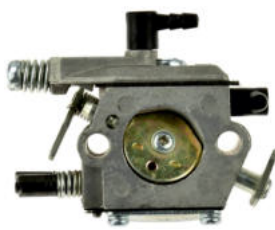

GB Carburetor
DE Vergaser
RU карбюратор
CZ Karburátor
SK Karburátor
HU Karburátor
RO Carburator

Kod EAN
5901477136054

John Gardener Kod produktu
Gaźnik do chińskiej piły spalinowej 52cc G81123 100



GB Carburetor
DE Vergaser
RU карбюратор
CZ Karburátor
SK Karburátor
HU Karburátor
RO Carburator

Kod EAN
5901477136061

John Gardener Kod produktu
Gaźnik do Husqvarny 136,137,141,142 G81124 100



GB Carburetor
DE Vergaser
RU карбюратор
CZ Karburátor
SK Karburátor
HU Karburátor
RO Carburator

Kod EAN
5901477128684

John Gardener Kod produktu
Gaźnik do Husqvarny 340 345 346 350 G81125 100



GB Carburetor
DE Vergaser
RU карбюратор
CZ Karburátor
SK Karburátor
HU Karburátor
RO Carburator

Kod EAN
5901477128691

John Gardener Kod produktu
Gaźnik do stihla 120 200 250 300 350 G81126 100



GB Clutch
DE Kupplung
RU сцепление
CZ Spojka
SK Spojka
HU Kuplung
RO Ambreiaj

Kod EAN
5901477149054

John Gardener Kod produktu
Sprzęgło do piły spalinowej Partner 351 Hus137 G81130 100



GB Clutch
DE Kupplung
RU сцепление
CZ Spojka
SK Spojka
HU Kuplung
RO Ambreiaj

Kod EAN
5901477149061

John Gardener Kod produktu
Sprzęgło do stihla 170 230 250 G81131 100



GB Clutch
DE Kupplung
RU сцепление
CZ Spojka
SK Spojka
HU Kuplung
RO Ambreiaj

Kod EAN
5901477128707

John Gardener Kod produktu
Zestaw sprzęgło + bęben sprzęgła + łożysko G81135 100



GB Starter china chainsaw
DE Starter für chinese kettensäge
RU Стартер для бензопилы
CZ Startování na motorové píly
SK Štartovanie na motorovej píly
HU Indító kínai láncfűrészhöz
RO Demaror

Kod EAN
5901477128714



John Gardener Kod produktu
Starter do chińskiej piły spalinowej 43cc-58cc G81136 100



GB Brake + housing for gasoline chainsaw
 DE Bremse + Gehäuse für Kettensäge
 RU Тормозная панель бензопилой
 CZ Skříň pro pily
 SK Skriňa pre píly
 HU Lánzfűrész alkatrészek
 RO Capac frana lant

Kod EAN
 5901477123856

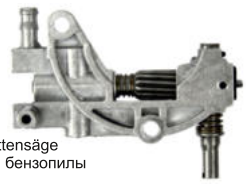
John Gardener Kod produktu 50
Hamulec + obudowa do pily spalinowej G81137 50

GB Ignition coil for chain saws
 DE Spule-Anlassmodul für Kettensäge
 RU Модуль Coil-события для бензопилы
 CZ Zapalovací cívka
 SK Zapalovacia cievka
 HU Gyújtótékercs
 RO Bobina aprindere

Kod EAN
 5901477124273

John Gardener Kod produktu 300
Pompka oleju do pily spalinowej G81139 300



GB Clutch
 DE Kupplung
 RU Сцепление
 CZ Spojka
 SK Spojka
 HU Kuplung
 RO Ambreiaj

Kod EAN
 5901477128721

John Gardener Kod produktu 100
Bęben sprzęgła + łożysko do Partnera 351 G81140 100



GB Clutch
 DE Kupplung
 RU Сцепление
 CZ Spojka
 SK Spojka
 HU Kuplung
 RO Ambreiaj

Kod EAN
 5901477128738

John Gardener Kod produktu 100
Bęben sprzęgła + łożysko do stihla 170 180 230 250 G81141 100

Nożyce do żywopłotu, trawy i krzewów / Hedge, grass and shrub shears



52cm



MAX 15mm



1850rpm



DC21V 2x2Ah

max 2.0km



MAX 9000/min



550 mm



600 ml



25 : 1



GB Cordless hedge trimmer
 DE Akku-Heckenschere
 RU Аккумуляторные ножницы для живой изгороди
 CZ Akumulátorové nůžky na živý plot
 SK Akumulátorové nožnice na živý plot
 HU Akkumulátoros sövénynyíró
 RO Foarfecă pentru gard viu cu acumulator

Kod EAN
 5903418302924

John Gardener Kod produktu 4
Nożyce akumulatorowe do żywopłotu 520mm 2x2.0Ah 21V G80660 4



GB Petrol hedge trimmer
 DE Benzin-Heckenscheren
 RU Бензоножницы
 CZ Plotostřih na živé ploty
 SK Plotostřih na živé ploty
 HU Benzines sövényvágó
 RO Tuns gard viu

Kod EAN
 5901477116735

John Gardener Kod produktu 1
Nożyce spalinowe do żywopłotu 55cm G81054 1

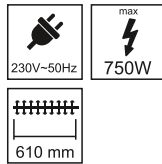
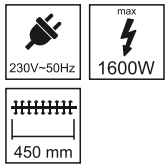

GB Hedge shears
DE Heckenscheren
RU Ножницы для живой изгороди
CZ Nůžky na živý plot
SK Nožnice na živý plot
HU Sövénynyíró olló
RO Foarfece pt. gard viu



John Gardener Kod produktu 4
Nożyce do żywopłotu elektryczne 450mm JG G83005 4

GB Hedge shears
DE Heckenscheren
RU Ножницы для живой изгороди
CZ Nůžky na živý plot
SK Nožnice na živý plot
HU Sövénynyíró olló
RO Foarfece pt. gard viu



John Gardener Kod produktu 4
Nożyce do żywopłotu elektryczne 610mm JG G83007 4

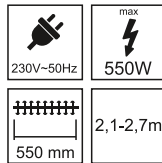
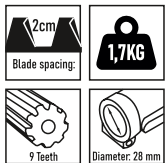

GB Hedge trimmer attachment
DE Heckenscherenaufsatz
RU Насадка для живой изгороди
CZ Nástavec na nůžky na živý plot
SK Nástavec nožnic na živý plot
HU Sövénynyíró tartozék
RO Accesoriu pentru tuns gard viu



John Gardener Kod produktu 12
Nożyce do żywopłotu – przystawka do kosy spalinowej G81064C 12

GB Pole hedge trimmer
DE Stabheckenschere
RU Штанговый мотоножницы
CZ Nůžky na živý plot
SK Tyčový plotostrih
HU Pólus sövénynyíró
RO Taietor de gard viu cu bară



John Gardener Kod produktu 1
Nożyce elektryczne do żywopłotu na wysięgniku 51cm G83009 1

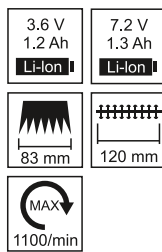
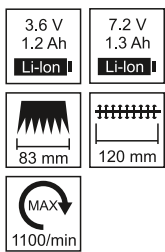

GB Cordless grass trimmer
DE Akku-Rasentrimmer
RU беспроводной триммер
CZ Akumulátorová strunová sekačka
SK Akumulátorová strunová sekačka
HU Akkus szegélynyíró
RO De tuns iarba cu acumulator



John Gardener Kod produktu 4
Nożyce akumulatorowe do trawy/krzewów 3.6V G83011 4
Nożyce akumulatorowe do trawy/krzewów 7.2V G83012 4

GB Cordless grass trimmer
DE Akku-Rasentrimmer
RU беспроводной триммер
CZ Akumulátorová strunová sekačka
SK Akumulátorová strunová sekačka
HU Akkus szegélynyíró
RO De tuns iarba cu acumulator



John Gardener Kod produktu 2
Nożyce akumulatorowe do trawy/krzewów 3.6V z rączką G83013 2
Nożyce akumulatorowe do trawy/krzewów 7.2V z rączką G83014 2

Przycinanie i cięcie / Pruning & Cutting

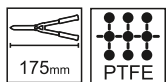

SK5



GB Anvil pruning shears
DE Amboss-Gartenschere
RU Секатор с наковаленкой
CZ Záhradní nůžky s kovadlinkovým ostřím
SK Záhradné nožnice s nákovkovou čepelou
HU Kovácsúllős metszőolló
RO Foarfecă de grădină cu lamă tip nicovală



Sekator ogrodniczy z ostrzem kowadełkowym 175mm SK5 PTFE T07400 6/72

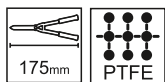

SK5



GB Bypass pruning shears
DE Bypass-Gartenschere
RU Секатор с обводным лезвием
CZ Záhradní nůžky s bypassovým ostřím
SK Záhradné nožnice s bypassovou čepelou
HU Mellévágó metszőolló
RO Foarfecă de grădină cu lamă bypass



Sekator ogrodniczy z ostrzem mijającym 175mm SK5 PTFE T07401 6/72

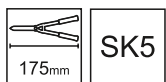

SK5



GB Straight bypass pruning shears
DE Gerade Bypass-Gartenschere
RU Прямой секатор с обводным лезвием
CZ Rovné záhradní nůžky s bypassovým ostřím
SK Rovné záhradné nožnice s nákovkovou čepelou
HU Egyenes mellévágó metszőolló
RO Foarfecă dreaptă de grădină cu lamă bypass



Sekator ogrodniczy prosty z ostrzem mijającym 175mm SK5 T07402 6/72

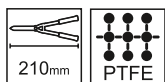

SK5



GB Anvil pruning shears
DE Amboss-Gartenschere
RU Секатор с наковаленкой
CZ Záhradní nůžky s kovadlinkovým ostřím
SK Záhradné nožnice s nákovkovou čepelou
HU Kovácsúllős metszőolló
RO Foarfecă de grădină cu lamă tip nicovală



Sekator ogrodniczy z ostrzem kowadełkowym 210mm SK5 PTFE T07405 6/72

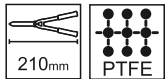

SK5

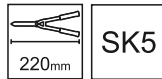

SK5



GB Bypass pruning shears
DE Bypass-Gartenschere
RU Секатор с обводным лезвием
CZ Zahradní nůžky s bypassovým ostřím
SK Záhradné nožnice s bypassovou čepelou
HU Mellévágó metszőolló
RO Foarfecă de grădină cu lamă bypass



Kod EAN
5901477198021

Sekator ogrodniczy z ostrzem mijającym 210mm SK5 PTFE T07406 6/72



GB Straight bypass pruning shears
DE Gerade Bypass-Gartenschere
RU Прямой секатор с обводным лезвием
CZ Rovné zahradní nůžky s bypassovým ostřím
SK Rovné záhradné nožnice s bypassovou čepelou
HU Egyenes mellévágó metszőolló
RO Foarfecă dreaptă de grădină cu lamă bypass



Kod EAN
5901477198038

Sekator ogrodniczy prosty z ostrzem mijającym 220mm SK5 T07411 6/72

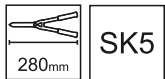

SK5

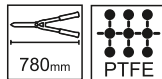

65Mn



GB Straight bypass pruning shears
DE Gerade Bypass-Gartenschere
RU Секатор с обводным лезвием
CZ Rovné zahradní nůžky s bypassovým ostřím
SK Rovné záhradné nožnice s bypassovou čepelou
HU Egyenes mellévágó metszőolló
RO Foarfecă dreaptă de grădină cu lamă bypass



Kod EAN
5901477198045

Sekator ogrodniczy prosty z ostrzem mijającym 280mm SK5 T07412 6/72



GB Bypass pruning shears
DE Bypass-Gartenschere
RU Секатор с обводным лезвием
CZ Zahradní nůžky s bypassovým ostřím
SK Záhradné nožnice s bypassovou čepelou
HU Mellévágó metszőolló
RO Foarfecă de grădină cu lamă bypass



Kod EAN
5901477198052

Sekator do gałęzi z ostrzem mijającym 780mm 65Mn PTFE T07415 12

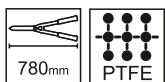

65Mn

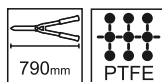

65Mn



GB Anvil lopper
DE Amboss-Astscherer
RU Сучкорез с наковаленкой
CZ Dvojrúční nůžky s kovádelkovým ostřím
SK Dvojručné nožnice s nákovkovou čepelou
HU Kovácsúllős ágévágó
RO Foarfecă pentru crengi cu lamă tip nicovală



Kod EAN
5901477198076

Sekator do gałęzi z ostrzem kowadelkowym 780mm 65Mn PTFE T07416 12



GB Gear bypass lopper
DE Getriebe-Astscherer mit Bypass-Klinge
RU Сучкорез с передачей и обводным лезвием
CZ Pákové nůžky na větve s převodem a bypassovým ostřím
SK Pákové nožnice na konáre s prevodom a bypassovou čepelou
HU Ágvágó áttétellel és mellévágó pengével
RO Foarfecă pentru crengi cu mecanism și lamă bypass



Kod EAN
5901477198069

Sekator do gałęzi z przekładnią i ostrzem mijającym 790mm 65Mn PTFE T07417 12

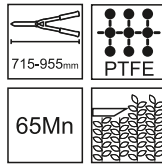
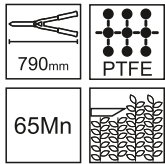

GB Gear anvil lopper
 DE Getriebe-Astscherer mit Amboss-Klinge
 RU Сучкорез с передачей и наковаленкой
 CZ Pákové nůžky na větve s převodem a kovádkovým ostřím
 SK Pákové nožnice na konáre s prevodom a nákovkovou čepelou
 HU Ágvágó áttétellel és kovácsüllős pengével
 RO Foarfecă pentru crengi cu mecanism și lamă tip nicovață



GB Telescopic bypass lopper
 DE Teleskop-Astscherer mit Bypass-Klinge
 RU Телескопический сучкорез с обводным лезвием
 CZ Teleskopické nůžky na větve s bypassovým ostřím
 SK Teleskopické nožnice na konáre s bypassovou čepelou
 HU Teleszkópos mellévágó ágvágó
 RO Foarfecă telescopică pentru crengi cu lamă bypass



Sekator do gałęzi z przekładnią i ostrzem kowadelkowym 790mm 65Mn PTFE T07418 12

Sekator teleskopowy do gałęzi z ostrzem mijającym 715-955mm 65Mn PTFE T07423 6/12

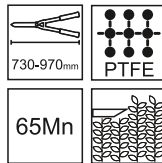
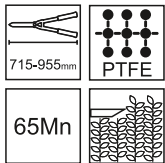

GB Telescopic anvil lopper
 DE Teleskop-Astscherer mit Amboss-Klinge
 RU Телескопический сучкорез с наковаленкой
 CZ Teleskopické nůžky na větve s kovádkovým ostřím
 SK Teleskopické nožnice na konáre s nákovkovou čepelou
 HU Teleszkópos kovácsüllős ágvágó
 RO Foarfecă telescopică pentru crengi cu lamă tip nicovață



GB Telescopic gear bypass pruner
 DE Teleskop-Gartenschere mit Getriebe und Bypass-Klinge
 RU Телескопический секатор с передачей и обводным лезвием
 CZ Teleskopické nůžky s převodem a bypassovým ostřím
 SK Teleskopické nožnice s prevodom a bypassovou čepelou
 HU Teleszkópos áttételes mellévágó metszőolló
 RO Foarfecă telescopică cu mecanism și lamă bypass



Sekator teleskopowy do gałęzi z ostrzem kowadelkowym 715-955mm 65Mn PTFE T07424 6/12

Sekator teleskopowy do gałęzi z przekładnią i ostrzem mijającym 730-970mm 65Mn PTFE T07425 6/12

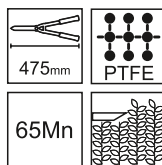
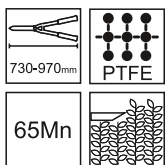

GB Telescopic gear anvil pruner
 DE Teleskop-Gartenschere mit Getriebe und Amboss-Klinge
 RU Ножницы для живой изгороди с волнистым лезвием
 CZ Nůžky na živý plot s vlnitým ostřím
 SK Nožnice na živý plot s vlnitou čepelou
 HU Hullámos pengéjű sövénynyíró olló
 RO Foarfecă telescopică cu mecanism și lamă tip nicovață



GB Hedge shears with wavy blade
 DE Heckenschere mit Wellenschliff
 RU Ножницы для живой изгороди с волнистым лезвием
 CZ Nůžky na živý plot s vlnitým ostřím
 SK Nožnice na živý plot s vlnitou čepelou
 HU Hullámos pengéjű sövénynyíró olló
 RO Foarfecă pentru gard viu cu lamă ondulată



Sekator teleskopowy do gałęzi z przekładnią i ostrzem kowadelkowym 730-970mm 65Mn PTFE T07426 6/12

Nożyce do żywoplotu z ostrzem falistym 475mm PTFE T07431 12

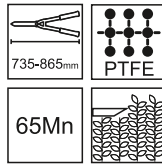
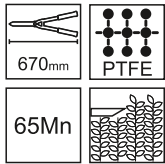

GB Hedge shears with wavy blade
 DE Heckenschere mit Wellenschliff
 RU Ножницы для живой изгороди с волнистым лезвием
 CZ Nůžky na živý plot s vlnitým ostřím
 SK Nožnice na živý plot s vlnitou čepelou
 HU Hullámos pengéjú sövénynyíró olló
 RO Foarfecă pentru gard viu cu lamă ondulată



GB Telescopic hedge shears with wavy blade
 DE Teleskop-Heckenschere mit Wellenschliff
 RU Телескопические ножницы для живой изгороди с волнистым лезвием
 CZ Teleskopické nůžky na živý plot s vlnitým ostřím
 SK Teleskopické nožnice na živý plot s vlnitou čepelou
 HU Teleszkópos sövénynyíró olló hullámos pengével
 RO Foarfecă telescopică pentru gard viu cu lamă ondulată



Nožyce do żywoplotu z ostrzem falistym 670mm PTFE T07432 12

Nožyce teleskopowe do żywoplotu z ostrzem falistym 735-865mm PTFE T07433 6/12

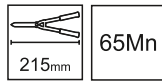
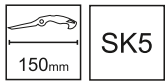

GB Folding saw
 DE Klappsäge
 RU Складная пила
 CZ Skládací pila
 SK Skladacia pila
 HU Összecsukható fűrész
 RO Ferăstrău pliabil



GB Bypass pruning shears
 DE Bypass-Gartenschere
 RU Секатор с обводным лезвием
 CZ Záhradní nůžky s bypassovým ostřím
 SK Záhradné nožnice s bypassovou čepelou
 HU Mellévágó metszőolló
 RO Foarfecă de grădină cu lamă bypass



Piła składana 150mm SK5 TPR T07438 6/72

Sekator ogrodniczy z ostrzem mijającym 215mm 65Mn G72006 6/72

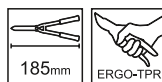
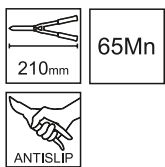

GB Bypass pruning shears
 DE Bypass-Gartenschere
 RU Секатор с обводным лезвием
 CZ Záhradní nůžky s bypassovým ostřím
 SK Záhradné nožnice s bypassovou čepelou
 HU Mellévágó metszőolló
 RO Foarfecă de grădină cu lamă bypass



GB Straight bypass pruning scissors
 DE Gerade Gartenschere mit Bypass-Klinge
 RU Прямой секатор-ножницы с обводным лезвием
 CZ Rovné záhradní nůžky s bypassovým ostřím
 SK Rovné záhradné nožnice s bypassovou čepelou
 HU Egyenes mellévágó metszőolló
 RO Foarfecă dreaptă de grădină cu lamă bypass



Sekator ogrodniczy z ostrzem mijającym 210mm 65Mn AntiSlip G72007 6/72

Sekator ogrodniczy – nożyczki proste z ostrzem mijającym 185mm ERGO-TPR G72008 12/120

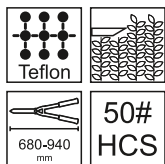
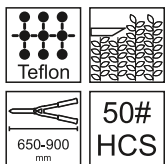

GB By-pass pruner
DE Rebenschere
RU Секатор
CZ Nožnice zahradnícke
SK Nožnice zahradnícke
HU Metszőolló
RO Foarfece pt. pomi



Kod EAN
5901477114182

John Gardener Kod produktu **Sekator teleskopowy 650-900mm do gałęzi, PP+TPR G72017 6**

GB By-pass pruner
DE Rebenschere
RU Секатор
CZ Nožnice zahradnícke
SK Nožnice zahradnícke
HU Metszőolló
RO Foarfece pt. pomi



Kod EAN
5901477114199

John Gardener Kod produktu **Sekator teleskopowy, kowadełkowy, przegubowy G72018 6**

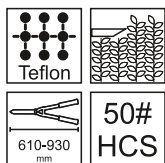
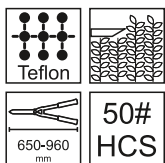

GB By-pass pruner
DE Rebenschere
RU Секатор
CZ Nožnice zahradnícke
SK Nožnice zahradnícke
HU Metszőolló
RO Foarfece pt. pomi



Kod EAN
5901477114205

John Gardener Kod produktu **Sekator teleskopowy, kowadełkowy, przegubowy G72020 6**

GB By-pass pruner
DE Rebenschere
RU Секатор
CZ Nožnice zahradnícke
SK Nožnice zahradnícke
HU Metszőolló
RO Foarfece pt. pomi



Kod EAN
5901477114212

John Gardener Kod produktu **Sekator do gałęzi teleskopowy 610-930mm G72021 6**

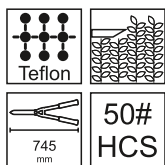
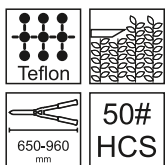

GB By-pass pruner
DE Rebenschere
RU Секатор
CZ Nožnice zahradnícke
SK Nožnice zahradnícke
HU Metszőolló
RO Foarfece pt. pomi



Kod EAN
5901477114229

John Gardener Kod produktu **Sekator do konarów teleskopowy, przegubowy G72022 6**

GB By-pass pruner
DE Rebenschere
RU Секатор
CZ Nožnice zahradnícke
SK Nožnice zahradnícke
HU Metszőolló
RO Foarfece pt. pomi



Kod EAN
5901477114281

John Gardener Kod produktu **Sekator do konarów kowadełkowy, przegubowy 700mm G72023 6**

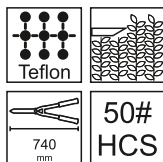
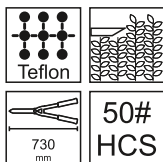

GB By-pass pruner
DE Rebenschere
RU Секатор
CZ Nožnice zahradnícke
SK Nožnice zahradnícke
HU Metszőolló
RO Foarfece pt. pomi



Kod EAN
5901477114298

John Gardener Kod produktu **Sekator do gałęzi 730mm ręczka PP+TPR G72024 6**

GB By-pass pruner
DE Rebenschere
RU Секатор
CZ Nožnice zahradnícke
SK Nožnice zahradnícke
HU Metszőolló
RO Foarfece pt. pomi



Kod EAN
5901477114236

John Gardener Kod produktu **Sekator do konarów,przekładniowy, kowadełkowy duży G72025 6**

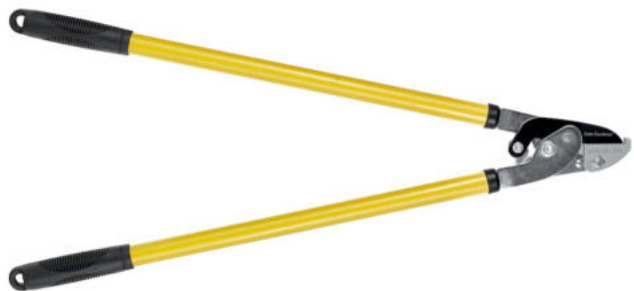
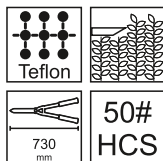
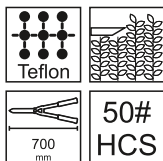

GB By-pass pruner
DE Rebenschere
RU Секатор
CZ Nožnice zahradnícke
SK Nožnice zahradnícke
HU Metszőolló
RO Foarfece pt. pomi



Kod EAN
5901477114243

John Gardener Kod produktu **Sekator do konarów 700mm,kowadełkowy G72026 6**

GB By-pass pruner
DE Rebenschere
RU Секатор
CZ Nožnice zahradnícke
SK Nožnice zahradnícke
HU Metszőolló
RO Foarfece pt. pomi



Kod EAN
5901477114250

John Gardener Kod produktu **Sekator do konarów,przegubowy,kowadełkowy duży G72027 6**

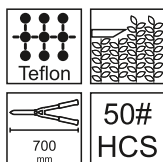
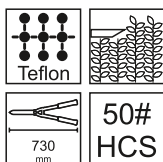

GB By-pass pruner
DE Rebenschere
RU Секатор
CZ Nožnice zahradnícke
SK Nožnice zahradnícke
HU Metszőolló
RO Foarfece pt. pomi



Kod EAN
5901477114267

John Gardener Kod produktu **Sekator do gałęzi 700mm,przegubowy G72028 6**

GB By-pass pruner
DE Rebenschere
RU Секатор
CZ Nožnice zahradnícke
SK Nožnice zahradnícke
HU Metszőolló
RO Foarfece pt. pomi



Kod EAN
5901477114274

John Gardener Kod produktu **Sekator do gałęzi 700mm G72029 12**

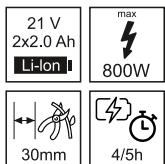

GB Cordless pruning shears
DE Kabellose Gartenschere
RU Аккумуляторные секаторы
CZ Akumulátorové nůžky na větve
SK Akumulátorové nožnice na konáre
HU Akkus metszőolló
RO Foarfece de grădinărit fără fir



Kod EAN
5901477187803

John Gardener Kod produktu 10
Sekator akumulatorowy 30mm w walizce 2x2.0Ah 21V G80662 10

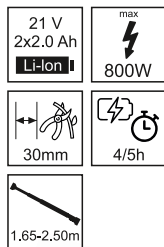

GB Cordless pruning shears
DE Kabellose Gartenschere
RU Аккумуляторные секаторы
CZ Akumulátorové nůžky na větve
SK Akumulátorové nožnice na konáre
HU Akkus metszőolló
RO Foarfece de grădinărit fără fir



Kod EAN
5901477199691

John Gardener Kod produktu 10
Sekator akumulatorowy 30mm w walizce 2x2.0Ah 21V G80663 10

300 mm



GB Grass shears
DE Handgrassschere
RU Ножницы для стрижки травы
CZ Nůžky na trávu
SK Nožnice na trávu
HU Forgatható fűvirító olló
RO Foarfece pt. gazon



Kod EAN
5901477114328

John Gardener Kod produktu 60
Nożyce do trawy 300mm G72055 60

300 mm



GB Grass shears
DE Handgrassschere
RU Ножницы для стрижки травы
CZ Nůžky na trávu
SK Nožnice na trávu
HU Forgatható fűvirító olló
RO Foarfece pt. gazon



Kod EAN
5901477114311

John Gardener Kod produktu 60
Nożyce do trawy obrotowe PROF1 300mm G72054 60



GB By-pass pruner
DE Rebenschere
RU Секатор
CZ Nožnice zahradnícke
SK Nožnice zahradnícke
HU Metszőolló
RO Foarfece pt. pomi



Kod EAN
5901477114168

John Gardener Kod produktu 12
Sekator do żywopłotu 640mm PROF1, alu. rączki G72012 12



GB By-pass pruner
DE Rebenschere
RU Секатор
CZ Nožnice zahradnícke
SK Nožnice zahradnícke
HU Metszőolló
RO Foarfece pt. pomi



Kod EAN
5901477114175

John Gardener Kod produktu 6
Sekator do żywopłotu teleskopowy 640-870mm G72014 6



GB By-pass pruner
DE Rebenschere
RU Секатор
CZ Nožnice zahradnícke
SK Nožnice zahradnícke
HU Metszőolló
RO Foarfece pt. pomi



5901477114151

John Gardener Kod produktu **Sekator do żywopłotu 520mm G72011 12**

GB By-pass pruner
DE Rebenschere
RU Секатор
CZ Nožnice zahradnícke
SK Nožnice zahradnícke
HU Metszőolló
RO Foarfece pt. pomi



5901477114090

John Gardener Kod produktu **Sekator ogrodowy 200mm, stal, czarna rączka G72001 60**



GB By-pass pruner
DE Rebenschere
RU Секатор
CZ Nožnice zahradnícke
SK Nožnice zahradnícke
HU Metszőolló
RO Foarfece pt. pomi



5901477114106

John Gardener Kod produktu **Sekator ogr. 200mm Profi drewniana rączka G72002 60**

GB By-pass pruner
DE Rebenschere
RU Секатор
CZ Nožnice zahradnícke
SK Nožnice zahradnícke
HU Metszőolló
RO Foarfece pt. pomi



5901477114113

John Gardener Kod produktu **Sekator ogrodniczy 200mm, plastik, rączka G72003 60**



GB By-pass pruner
DE Rebenschere
RU Секатор
CZ Nožnice zahradnícke
SK Nožnice zahradnícke
HU Metszőolló
RO Foarfece pt. pomi



5901477114137

John Gardener Kod produktu **Sekator ogr. 200mm Profi alu. rączka G72005 60**

GB Garden grafting tools kit
DE Veredelungswerkzeugsatz für den Garten
RU Набор садовых прививочных инструментов
CZ Sada zahradního nářadí pro roubování
SK Súprava záhradných nástrojov na štepenie
HU Kerti oltványkészlet
RO Kit de unelte de altoire pentru grădina



5901477182907

Kod produktu **Sekator – nożyce do szczepienia drzew i krzewów G71999 20**

350
mm



2.4
m



GB Leverage tree pruner
DE Baumsäge mit astschere
RU Сучкорез штанговый с пилой
CZ Stříhač na větve s pilovým listem
SK Strihač na konáre s pilovým listom
HU Kötéles ágvágó
RO Fierastrau pt. pomi cu prelungitor



Kod EAN
5901477114304

John Gardener Kod produktu 12
Sekator tyczkowy z piłką 350mm G72057 12

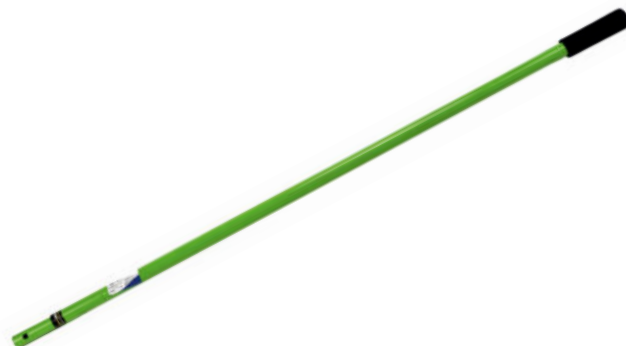

GB Telescopic handle
DE Teleskopstange
RU Ручьятка телескопическая
CZ Teleskopický prodlužovač
SK Teleskopický predĺžovač
HU Teleszkópos hosszabbító
RO Prelungitor telescopic



Kod EAN
5901477167171

John Gardener Kod produktu 12
Trzonek metalowy do sekatora tyczkowego 2.4m G72058 12



180
mm

7T



65
Mn

50-54
HRC



GB Hand saw for wood
DE Handsäge
RU Пила по дереву
CZ Pila na dřevo
SK Pila na drevo
HU Fafűrész, egyenes
RO Fierastrau „coada de vulpe” - pt. lemn



Kod EAN
5901477145025

John Gardener Kod produktu 48
Piła do drewna składana 180mm, 65 Mn G33108 48



350
mm

7T



65
Mn

PTFE



GB Curved saw with sheath
DE Gebogene Säge mit Holster
RU Изогнутая пила с чехлом
CZ Zahnutá pila s pouzdröm
SK Zahnutá pila s puzdrom
HU Hajlított fűrész tokkal
RO Ferăstrău curbă cu teacă



Kod EAN
5901477197543

John Gardener Kod produktu 48
Piła wygięta 35cm z powłoką PTFE i kaburą 65Mn G72085 48



300
mm

7T



65
Mn

PTFE



GB Straight saw with sheath
DE Gerade Säge mit Holster
RU Прямая пила с чехлом
CZ Rovná pila s pouzdröm
SK Rovná pila s puzdrom
HU Egyenes fűrész tokkal
RO Ferăstrău drept cu teacă



Kod EAN
5901477197550

John Gardener Kod produktu 48
Piła prosta 30cm z powłoką PTFE i kaburą 65Mn G72086 48



320
mm

SK5

55-60
HRC



GB Hook saw
DE Säge mit Haken
RU Пила с крюком
CZ Pila s hákom
SK Pila s hákom
HU Karpós fűrész
RO Ferăstrău cu cârtig



Kod EAN
5901477197529

John Gardener Kod produktu 48
Piła z hakiem 32cm SK5 G72090 48

 320 mm
SK5 55-60 HRC



GB Hook saw for handle
DE Säge mit Haken für Stiel
RU Пила с крюком на рукоятку
CZ Pila s hákem na násadu
SK Pila s hákom na násadu
HU Kampós fűrész nyélre
RO Ferăstrău cu cârlig pentru mâner

Kod EAN

5901477197536

John Gardener Kod produktu 
Pila z hakiem 32cm na trzonek SK5 G72091 48

 360 mm 1.8-3.3 m
SK5 55-60 HRC

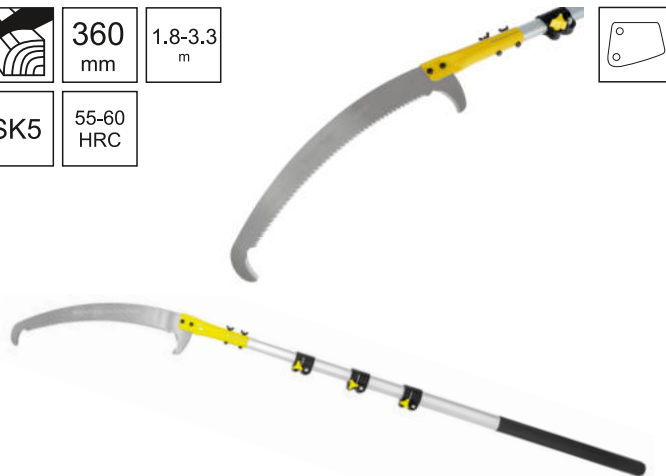

GB Hook saw with telescopic handle
DE Säge mit Haken auf Teleskopstiel
RU Пила с крюком на телескопической рукоятке
CZ Pila s hákem na teleskopické násadě
SK Pila s hákom na teleskopickéj násade
HU Kampós fűrész teleszkópos nyéllel
RO Ferăstrău cu cârlig pe mâner telescopic

Kod EAN

5901477197505

John Gardener Kod produktu 
Pila z hakiem 36cm na trzonku teleskopowym 3,3m SK5 G72094 12

 360 mm 1.86-5.5 m
SK5 55-60 HRC

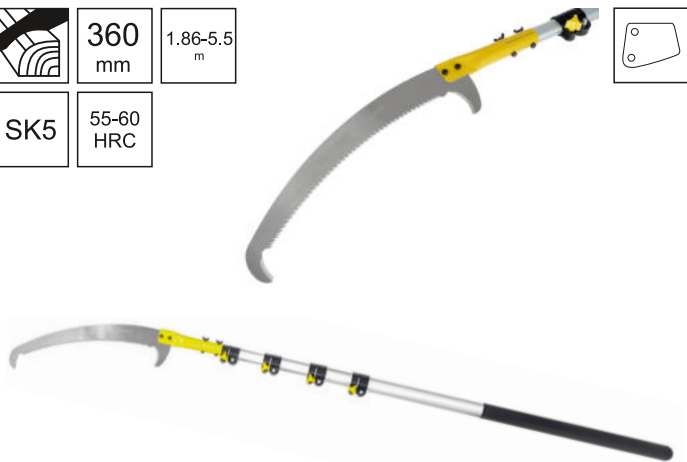

GB Hook saw with telescopic handle
DE Säge mit Haken auf Teleskopstiel
RU Пила с крюком на телескопической рукоятке
CZ Pila s hákem na teleskopické násadě
SK Pila s hákom na teleskopickéj násade
HU Kampós fűrész teleszkópos nyéllel
RO Ferăstrău cu cârlig pe mâner telescopic

Kod EAN

5901477197512

John Gardener Kod produktu 
Pila z hakiem 36cm na trzonku teleskopowym 5,5m SK5 G72095 10

600 G 14"
ANTI-SHOCK GRIP
PTFE



GB Axe hammer
DE Axt-Hammer
RU Топор-молот
CZ Sekero-kladivo
SK Sekero-kladivo
HU Balta-kalapács
RO Topor-ciocan

Kod EAN

5901477198601

Ivanko Kod produktu 
Siekiero-mlot 600g ANTI-SHOCK MONOBLOCK T00403 24

600 G 14"

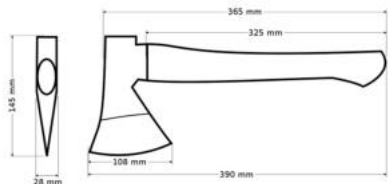

GB Axe
DE Handbeil
RU Топор
CZ Sekyrka
SK Sekerka
HU Szekerce
RO Toporisca

Kod EAN

5901477100154

Ivanko Kod produktu 
Siekiera PROFI 600Gx14" (drewniany trzonek) G72210 24

800 G 14"

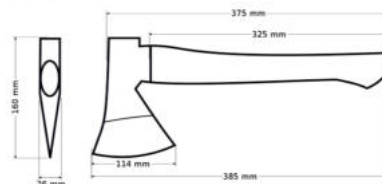

GB Axe
DE Handbeil
RU Топор
CZ Sekyrka
SK Sekerka
HU Szekerce
RO Toporisca

Kod EAN

5901477100161

Ivanko Kod produktu 
Siekiera PROFI 800Gx14" (drewniany trzonek) G72211 24

1000 G 18"

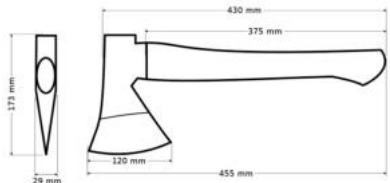

GB Axe
DE Handbeil
RU Tonop
CZ Sekyrka
SK Sekerka
HU Szekerce
RO Toporisca



Kod EAN
5901477100178

Siekiera PROFI 1000Gx18" (drewniany trzonek) Kod produktu: G72212 24

1250 G 24"

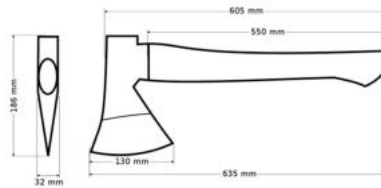

GB Axe
DE Handbeil
RU Tonop
CZ Sekyrka
SK Sekerka
HU Szekerce
RO Toporisca



Kod EAN
5901477100185

Siekiera PROFI 1250Gx24" (drewniany trzonek) Kod produktu: G72213 12

1600 G 32"

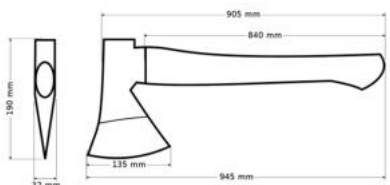

GB Axe
DE Handbeil
RU Tonop
CZ Sekyrka
SK Sekerka
HU Szekerce
RO Toporisca



Kod EAN
5901477100192

Siekiera PROFI 1600Gx32" (drewniany trzonek) Kod produktu: G72215 12

600 G 14"



GB Axe
DE Handbeil
RU Tonop
CZ Sekyrka
SK Sekerka
HU Szekerce
RO Toporisca



Kod EAN
5901477100208

Siekiera 600Gx14" fiberglass Geko Premium Kod produktu: G72220 24

800 G 15"



GB Axe
DE Handbeil
RU Tonop
CZ Sekyrka
SK Sekerka
HU Szekerce
RO Toporisca



Kod EAN
5901477100215

Siekiera 800Gx15" fiberglass Geko Premium Kod produktu: G72221 24

1000 G 18"



GB Axe
DE Handbeil
RU Tonop
CZ Sekyrka
SK Sekerka
HU Szekerce
RO Toporisca



Kod EAN
5901477100222

Siekiera 1000Gx18" fiberglass Geko Premium Kod produktu: G72222 24

600
G

1250
G

2000
G



1250
G

28"



GB Splitting axe set
DE Spaltaxt-Set
RU Набор колунов
CZ Sada štípacích seker
SK Sada štípacích seker
HU Hasítófejsze készlet
RO Set de topoare pentru despicat lemne



Kod EAN
5901477150791

Zestaw siekier rozlupejących 3 el. 600g/1250g/2000g G72295 4

GB Axe
DE Handbeil
RU Tonop
CZ Sekyřka
SK Sekerka
HU Szeķerce
RO Toporisca



Kod EAN
5901477100239

Siekiera 1250Gx28" fiberglass Geko Premium G72223 12

1600
G

36"



GB Axe
DE Handbeil
RU Tonop
CZ Sekyřka
SK Sekerka
HU Szeķerce
RO Toporisca



Kod EAN
5901477100246

Siekiera 1600Gx36" fiberglass Geko Premium G72225 12



GB Axe
DE Handbeil
RU Tonop
CZ Sekyřka
SK Sekerka
HU Szeķerce
RO Toporisca



Kod EAN
5901477147814

Siekiera ciesielska - Toperek 14" 620g TVARDY T02-001 24



GB Axe
DE Handbeil
RU Tonop
CZ Sekyřka
SK Sekerka
HU Szeķerce
RO Toporisca



Kod EAN
5901477147821

Siekiera ciesielska 17,5" 850g TVARDY T02-002 12



GB Axe
DE Handbeil
RU Tonop
CZ Sekyřka
SK Sekerka
HU Szeķerce
RO Toporisca



Kod EAN
5901477147838

Siekiera rozlupejąca 17,5" 1000g TVARDY T02-003 12



GB Axe
DE Handbeil
RU Tonop
CZ Sekyrka
SK Sekerka
HU Szekerce
RO Toporisca



Siekiera ciesielska 28" 1350g TVARDY T02-004 8

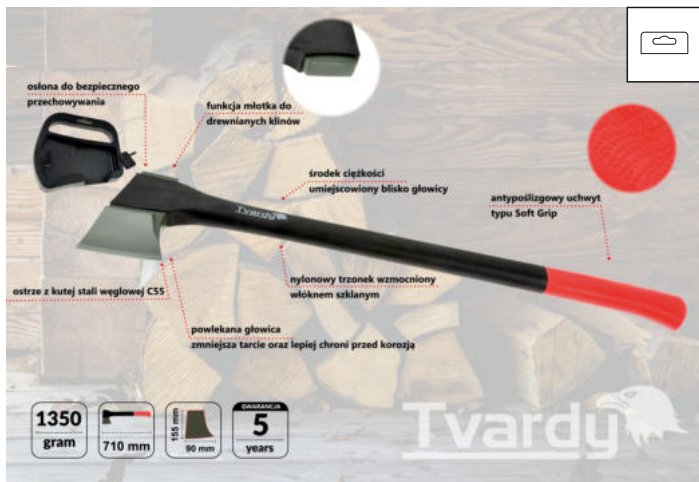

GB Axe
DE Handbeil
RU Tonop
CZ Sekyrka
SK Sekerka
HU Szekerce
RO Toporisca



Siekiera Rozłupująca 28" 1550g TVARDY T02-005 8



GB Axe
DE Handbeil
RU Tonop
CZ Sekyrka
SK Sekerka
HU Szekerce
RO Toporisca



Siekiera ciesielska 31,5" 2150g TVARDY T02-006 4



GB Axe
DE Handbeil
RU Tonop
CZ Sekyrka
SK Sekerka
HU Szekerce
RO Toporisca



Siekiera Rozłupująca 31,5" 2400g TVARDY T02-007 4

2000 G



GB Axe
DE Handbeil
RU Tonop
CZ Sekyrka
SK Sekerka
HU Szekerce
RO Toporisca



Siekiera rozłupująca 2 kg r.fiberglass Geko Premium G72230 6

1000 G



GB Axe
DE Handbeil
RU Tonop
CZ Sekyrka
SK Sekerka
HU Szekerce
RO Toporisca



Siekiera rozłupująca 1 kg r.fiberglass Geko Premium G72231 12

2700
G



GB Axe
DE Handbeil
RU Топор
CZ Sekyrka
SK Sekerka
HU Szekerce
RO Toporisca



Kod produktu 5901477120602

Siekiera rozłupująca 2,7 kg r.fiberglass Geko Premium G72232 6

3600
G



GB Axe
DE Handbeil
RU Топор
CZ Sekyrka
SK Sekerka
HU Szekerce
RO Toporisca



Kod produktu 5901477120619

Siekiera rozłupująca 3,6 kg r.fiberglass Geko Premium G72233 6

2000
G



GB Axe
DE Handbeil
RU Топор
CZ Sekyrka
SK Sekerka
HU Szekerce
RO Toporisca



Kod produktu 5901477115141

Siekiera rozłupująca 2 kg r.drewno Geko Premium G72234 6

1000
G



GB Axe
DE Handbeil
RU Топор
CZ Sekyrka
SK Sekerka
HU Szekerce
RO Toporisca



Kod produktu 5901477115134

Siekiera rozłupująca 1 kg r.drewno Geko Premium G72235 12

2000
G

stal



GB Wood splitter
DE Spaltkeil
RU Клиn для раскалывания бревен
CZ Klin na štípaní polen
SK Klin na štiepanie polien
HU Pana pt. lemn
RO Fahasító ék



Kod produktu 5901477191695

Klin skrzętny do rozłupywania drewna 2kg stalowy G72204 10

1800
G

stal



GB Wood splitter
DE Spaltkeil
RU Клиn для раскалывания бревен
CZ Klin na štípaní polen
SK Klin na štiepanie polien
HU Pana pt. lemn
RO Fahasító ék



Kod produktu 5901477191701

Klin poczwórny do rozłupywania drewna 1,8kg stalowy G72206 10

2000 G	3000 G	stal
235x55x34 mm	265x58x42 mm	



GB Wood splitter
DE Spaltkeil
RU Клин для раскалывания бревен
CZ Klín na štípaní polen
SK Klín na štiepanie polien
HU Pana pt. lemn
RO Fahasító ék



GEKO	Kod produktu	
Klín do roztlupywania drewna 2kg stalowy	G72201	10
Klín do roztlupywania drewna 3kg stalowy	G72202	6

115 G	262 G	262 G	ABS
6" 152x66x25 mm	8" 203x89x30,5 mm	10" 254x89x30,5 mm	



GB Wood splitter
DE Spaltkeil
RU Клин для раскалывания бревен
CZ Klín na štípaní polen
SK Klín na štiepanie polien
HU Pana pt. lemn
RO Fahasító ék



GEKO	Kod produktu	
Klín drwalcki do wycinki drzewa 6" ABS	G72207	100
Klín drwalcki do wycinki drzewa 8" ABS	G72208	40
Klín drwalcki do wycinki drzewa 10" ABS	G72209	40

400 G



GB Pickaxe
DE Spitzhacke
RU Кирка
CZ Krumpáč
SK Krompáč
HU Csákány
RO Târnăcop



GEKO	Kod produktu	
Kilof 400g fiberglass	G66529	24

2500 G



GB Pickaxe
DE Spitzhacke
RU Кирка
CZ Krumpáč
SK Krompáč
HU Csákány
RO Târnăcop



GEKO	Kod produktu	
Kilof 2,5kg (drewniany trzonek)	G66526	6

rozmiar 3 18mm	10 szt.
----------------------	------------



GB Metal wedge for the handle
DE Metallkeil für den Griff
RU Металлический клин для ручки
CZ Kovový klín na rukojeť
SK Kovový klín na rukoväť
HU Fém ék a fogantyúhoz
RO Pena metalica pentru maner



GEKO	Kod produktu	
Klín do trzonka r.3	G72216	1

rozmiar 4 26mm	10 szt.
----------------------	------------



GB Metal wedge for the handle
DE Metallkeil für den Griff
RU Металлический клин для ручки
CZ Kovový klín na rukojeť
SK Kovový klín na rukoväť
HU Fém ék a fogantyúhoz
RO Pena metalica pentru maner



GEKO	Kod produktu	
Klín do trzonka r.4	G72217	1

rozmiar
5
35mm

10
szt.



rozmiar
6
45mm

10
szt.



GB Metal wedge for the handle
DE Metallkeil für den Griff
RU Металлический клин для ручки
CZ Kovový klín na rukojeť
SK Kovový klín na rukoväť
HU Fém ék a fogantyúhoz
RO Pena metalica pentru maner



Kod EAN
5901477194399

Klin do trzonka r.5 Kod produktu **G72218** 1

GB Metal wedge for the handle
DE Metallkeil für den Griff
RU Металлический клин для ручки
CZ Kovový klín na rukojeť
SK Kovový klín na rukoväť
HU Fém ék a fogantyúhoz
RO Pena metalica pentru maner



Kod EAN
5901477194405

Klin do trzonka r.6 Kod produktu **G72219** 1

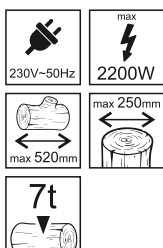

GB Electric log splitter with a stand
DE Elektrischer Holzspalter mit Ständer
RU Электрический дровокол с подставкой
CZ Elektrická štípačka dřeva se stojanem
SK Elektrická štípačka dreva so stojanom
HU Elektromos rönkhasító állványval
RO Despicator de busteni electric cu suport



Kod EAN
5901477187711

Łuparka do drewna 7T 2200W ze stojakiem Kod produktu **G72198** 1



GB Multi Sharpener 2in1
DE Multischärfer 2in1
RU Мультиочилка 2в1
CZ Multi ořezávátka 2v1
SK Multi brúska 2v1
HU Többszörös élező 2 az 1-ben
RO Ascuțitoare multiplă 2in1



Kod EAN
5901477192715

Ostrzałka do noży i siekier 2w1 – kartonik wystawowy Kod produktu **T02-009** 12/48

20,5"



GB Billhook saw
DE Billhook sah
RU Биллхук увидел
CZ Billhook viděl
SK Billhook videl
HU Billhook látta
RO Billhook a văzut



Kod EAN
5901477192616

Tasak karczownik z piłą 20,5" Kod produktu **T02-010** 24

20,5"



GB Brush hook
DE Bürstenhaken
RU Крючок для кисти
CZ Háček na kartáč
SK Háčik na kefu
HU Kefe kampó
RO Cârțig pentru perie



Kod EAN
5901477192623

Tasak karczownik 20,5" Kod produktu **T02-011** 24

Rozdrabniacze do gałęzi / siewniki / Garden Shredders/Seeders



230V-50Hz
 max 2000W
 MAX 4050/min
 39mm
50L



2.7L
 4x AA 6V DC not included
 15-50 gr/m²
 700-1800 obr/min



GB Garden shredder
 DE Garten-Häcksler
 RU Садовый измельчитель
 CZ Zahradní drtič
 SK Záhradný drvič
 HU Elektromos kerti szecskázó
 RO Tocător concasor electric de grădină



John Gardener
Rozdrabniacz do gałęzi 2000W
Kod produktu G81075 1

GB Garden seeder
 DE Garten-Sämaschine
 RU Садовая сеялка
 CZ Zahradní sečák
 SK Záhradná sejačka
 HU Kerti vetőgép
 RO Semănătoare de grădină



John Gardener
Siewnik ogrodowy na baterie 2,7L
Kod produktu G72065 4

3L
 4 Tryby Rosiewu
 0,5-2m



12L
 10 Tryby Rosiewu
 46,5cm



GB Garden seeder
 DE Garten-Sämaschine
 RU Садовая сеялка
 CZ Zahradní sečák
 SK Záhradná sejačka
 HU Kerti vetőgép
 RO Semănătoare de grădină



John Gardener
Siewnik ogrodowy 3L
Kod produktu G72067 8

GB Garden seeder
 DE Garten-Sämaschine
 RU Садовая сеялка
 CZ Zahradní sečák
 SK Záhradná sejačka
 HU Kerti vetőgép
 RO Semănătoare de grădină



John Gardener
Siewnik ogrodowy 12L
Kod produktu G72068 4

Opryskiwacze ogrodowe / Sprayers



2.13kW
 14L
 7500/min
 max 11m
 4l/min



2.13kW
 20L
 7500/min
 max 12m
 4l/min



GB Diffusion gasoline sprinkler
 DE Ruckenspritze mit Verbrennungsmotor
 RU Диффузионный бензиновый опрыскиватель
 CZ Motorový zadový postřikovač
 SK Motorová chrbtovú postrekovač
 HU Robbanómotoros hátí permetezőgépek
 RO Dispozitiv pt. stropit cu combustibil purtat in spate



Kod produktu **Opryskiwacz spalinowy 14L** G81080 1

GB Diffusion gasoline sprinkler
 DE Ruckenspritze mit Verbrennungsmotor
 RU Диффузионный бензиновый опрыскиватель
 CZ Motorový zadový postřikovač
 SK Motorová chrbtovú postrekovač
 HU Robbanómotoros hátí permetezőgépek
 RO Dispozitiv pt. stropit cu combustibil purtat in spate



Kod produktu **Opryskiwacz spalinowy 20L** G81081 1

2.13kW
 26L
 7500/min
 max 12m
 4l/min



2.13kW
 14L
 7500/min
 max 11m
 4l/min



GB Diffusion gasoline sprinkler
 DE Ruckenspritze mit Verbrennungsmotor
 RU Диффузионный бензиновый опрыскиватель
 CZ Motorový zadový postřikovač
 SK Motorová chrbtovú postrekovač
 HU Robbanómotoros hátí permetezőgépek
 RO Dispozitiv pt. stropit cu combustibil purtat in spate



Kod produktu **Opryskiwacz spalinowy 26L** G81082 1

GB Diffusion gasoline sprinkler
 DE Ruckenspritze mit Verbrennungsmotor
 RU Диффузионный бензиновый опрыскиватель
 CZ Motorový zadový postřikovač
 SK Motorová chrbtovú postrekovač
 HU Robbanómotoros hátí permetezőgépek
 RO Dispozitiv pt. stropit cu combustibil purtat in spate



Kod produktu **Opryskiwacz spalinowy 14L** H00661 1

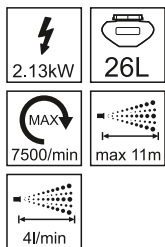
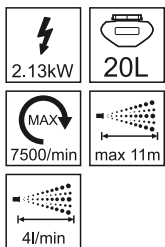

GB Diffusion gasoline sprinkler
 DE Ruckenspritze mit Verbrennungsmotor
 RU Диффузионный бензиновый опрыскиватель
 CZ Motorový zádový postřikovač
 SK Motorová chrbtovú postrekovač
 HU Robbanómotoros hátí permetezőgép
 RO Dispozitiv pt. stropit cu combustibil purtat in spate



Heidmann Kod produktu 1
Opryskiwacz spalinowy 20L H00662

GB Diffusion gasoline sprinkler
 DE Ruckenspritze mit Verbrennungsmotor
 RU Диффузионный бензиновый опрыскиватель
 CZ Motorový zádový postřikovač
 SK Motorová chrbtovú postrekovač
 HU Robbanómotoros hátí permetezőgép
 RO Dispozitiv pt. stropit cu combustibil purtat in spate



Heidmann Kod produktu 1
Opryskiwacz spalinowy 26L H00663

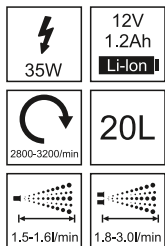
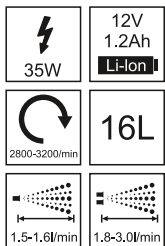

GB Battery sprayer
 DE Batterie Sprayer
 RU Опрыскиватель батареи
 CZ Ruční tlakový postřikovač
 SK Ručný tlakový postrekovač
 HU Permetező kézi
 RO Vermorel



EKO Kod produktu 1
Opryskiwacz akumulatorowy 16L G73215

GB Battery sprayer
 DE Batterie Sprayer
 RU Опрыскиватель батареи
 CZ Ruční tlakový postřikovač
 SK Ručný tlakový postrekovač
 HU Permetező kézi
 RO Vermorel



EKO Kod produktu 1
Opryskiwacz akumulatorowy 20L G73216

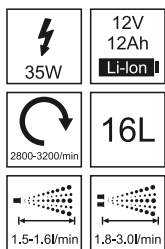
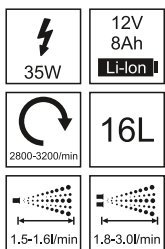

GB Battery sprayer
 DE Batterie Sprayer
 RU Опрыскиватель батареи
 CZ Ruční tlakový postřikovač
 SK Ručný tlakový postrekovač
 HU Permetező kézi
 RO Vermorel





EKO Kod produktu 1
Opryskiwacz akumulatorowy plecakowy 16L Lekki G73251

GB Battery sprayer
 DE Batterie Sprayer
 RU Опрыскиватель батареи
 CZ Ruční tlakový postřikovač
 SK Ručný tlakový postrekovač
 HU Permetező kézi
 RO Vermorel



EKO Kod produktu 1
Opryskiwacz akumulatorowy plecakowy 16L Lekki Blue G73252

 35W	12V 8Ah
 2800-3200/min	12L
 1.5-1.6l/min	 1.8-3.0l/min







GB Battery sprayer
DE Batterie Sprayer
RU Опрыскиватель батареи
CZ Ruční tlakový postřikovač
SK Ručný tlakový postrekovač
HU Permetező kézi
RO Vermorel



Kod EAN
5901477185984

Opryskiwacz akumulatorowy 12L Kod produktu **G73249** 1

 35W	12V 8Ah
 2800-3200/min	16L
 1.5-1.6l/min	 1.8-3.0l/min



GB Battery sprayer
DE Batterie Sprayer
RU Опрыскиватель батареи
CZ Ruční tlakový postřikovač
SK Ručný tlakový postrekovač
HU Permetező kézi
RO Vermorel



Kod EAN
5901477185977

Opryskiwacz akumulatorowy 16L z dodatk. wyposażeniem Kod produktu **G73217** 1

max 168cm

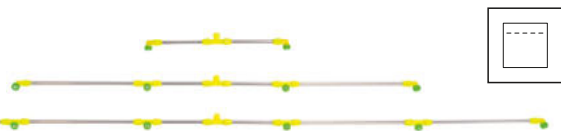

GB Lance
DE Lanze
RU Копье
CZ Nástavec postřikovače
SK Nástavec postrekovače
HU Lándzsa
RO Lance



Kod EAN
5901477186271

Lanca do opryskiwaczy szeroka 6 - dyszowa Kod produktu **G73263** 100

7pcs

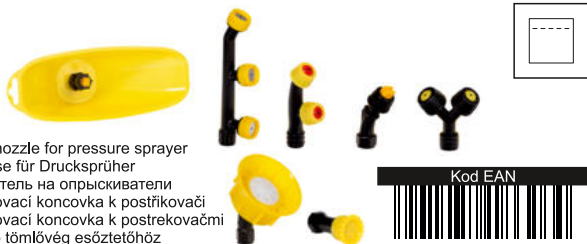



GB Straight nozzle for pressure sprayer
DE Sprühdüse für Drucksprüher
RU Распылитель на опрыскиватели
CZ Rozprašovací koncovka k postřikovači
SK Rozprašovací koncovka k postrekovači
HU Porlasztó tömlővég eszétetőhöz
RO Doza pt. vermorel



Kod EAN
5901477186264

Zestaw dysz do opryskiwaczy 7el. Kod produktu **G73247** 100

3.7 V 200 mAh	
	1L
	USB Type-C





GB Battery sprayer
DE Batterie Sprayer
RU Опрыскиватель батареи
CZ Ruční tlakový postřikovač
SK Ručný tlakový postrekovač
HU Permetező kézi
RO Vermorel



Kod EAN
5901477197307

Opryskiwacz akumulatorowy 1L Kod produktu **G73271** 1

12 V 1.3 Ah	min 60cm max 90cm
 230V-50Hz	5L
 3.1 L/min	





GB Battery sprayer
DE Batterie Sprayer
RU Опрыскиватель батареи
CZ Ruční tlakový postřikovač
SK Ručný tlakový postrekovač
HU Permetező kézi
RO Vermorel



Kod EAN
5901477197314

Opryskiwacz akumulatorowy 5L Kod produktu **G73273** 1

12 V 1.3 Ah	min 60cm max 90cm
 230V-50Hz	8L
 3.1 L/min	



GB Battery sprayer
DE Batterie Sprayer
RU Опрыскиватель батареи
CZ Ruční tlakový postřikovač
SK Ručný tlakový postrekovač
HU Permetező kézi
RO Vermorel



Kod EAN
5901477197321

Opryskiwacz akumulatorowy 8L Kod produktu **G73274** 1

8L



GB Pressure sprayer
DE Drucksprüher
RU Ручной опрыскиватель
CZ Ruční tlakový postřikovač
SK Ručný tlakový postrekovač
HU Permetező kézi
RO Vermorel

Kod EAN
5901477143700

Kod produktu 6
Opryskiwacz SX-8 do chemii agresywnej 8L G73232 6

16L 40cm



GB Pressure sprayer
DE Drucksprüher
RU Ручной опрыскиватель
CZ Ruční tlakový postřikovač
SK Ručný tlakový postrekovač
HU Permetező kézi
RO Vermorel

Kod EAN
5901477143724

Kod produktu 2
Opryskiwacz ciśnieniowy na kołach 16L G73233 2

5L 43cm



GB Pressure sprayer
DE Drucksprüher
RU Ручной опрыскиватель
CZ Ruční tlakový postřikovač
SK Ručný tlakový postrekovač
HU Permetező kézi
RO Vermorel

Kod EAN
5901477127342

Kod produktu 6
Opryskiwacz ciśnieniowy 5L ORANGE G73235 6

8L 43cm



GB Pressure sprayer
DE Drucksprüher
RU Ручной опрыскиватель
CZ Ruční tlakový postřikovač
SK Ručný tlakový postrekovač
HU Permetező kézi
RO Vermorel

Kod EAN
5901477127359

Kod produktu 6
Opryskiwacz ciśnieniowy 8L ORANGE G73238 6

12L 48cm



GB Pressure sprayer
DE Drucksprüher
RU Ручной опрыскиватель
CZ Ruční tlakový postřikovač
SK Ručný tlakový postrekovač
HU Permetező kézi
RO Vermorel

Kod EAN
5901477124495

Kod produktu 1
Opryskiwacz plecakowy 12L G73214 1

16L 48cm



GB Pressure sprayer
DE Drucksprüher
RU Ручной опрыскиватель
CZ Ruční tlakový postřikovač
SK Ručný tlakový postrekovač
HU Permetező kézi
RO Vermorel

Kod EAN
5901477100611

Kod produktu 1
Opryskiwacz 18L G73204 1

2L



GB Pressure sprayer
DE Drucksprüher
RU Ручной опрыскиватель
CZ Ruční tlakový postřikovač
SK Ručný tlakový postrekovač
HU Permetező kézi
RO Vermorel

Kod EAN
5901477140587

Kod produktu 20
Opryskiwacz ciśnieniowy 2L + dysza G73230 20

1.5L



GB Pressure sprayer
DE Drucksprüher
RU Ручной опрыскиватель
CZ Ruční tlakový postřikovač
SK Ručný tlakový postrekovač
HU Permetező kézi
RO Vermorel

Kod EAN
5901477143717

Kod produktu 15
Opryskiwacz ciśnieniowy 1,5L z regulowaną dyszą G73231 15

0.75L



GB Pressure sprayer
DE Drucksprüher
RU Ручной опрыскиватель
CZ Ruční tlakový postřikovač
SK Ručný tlakový postrekovač
HU Permetező kézi
RO Vermorel

Kod EAN
5901477165719

Kod produktu 100
Opryskiwacz ręczny 0,75L G73255 100

2L



GB Pressure sprayer
DE Drucksprüher
RU Ручной опрыскиватель
CZ Ruční tlakový postřikovač
SK Ručný tlakový postrekovač
HU Permetező kézi
RO Vermorel

Kod EAN
5901477100581

Kod produktu 20
Opryskiwacz 2l G73201 20

1L



GB Pressure sprayer
DE Drucksprüher
RU Ручной опрыскиватель
CZ Ruční tlakový postřikovač
SK Ručný tlakový postrekovač
HU Permetező kézi
RO Vermorel

Kod EAN
5901477170553

Kod produktu 20
Opryskiwacz ciśnieniowy 1L G73265 20

2L



GB Pressure sprayer
DE Drucksprüher
RU Ручной опрыскиватель
CZ Ruční tlakový postřikovač
SK Ručný tlakový postrekovač
HU Permetező kézi
RO Vermorel

Kod EAN
5903418301248

Kod produktu 20
Opryskiwacz ciśnieniowy pomarańczowy 2L G73265-2 20

3L



GB Pressure sprayer
DE Drucksprüher
RU Ручной опрыскиватель
CZ Ruční tlakový postřikovač
SK Ručný tlakový postrekovač
HU Permetező kézi
RO Vermorel

Kod EAN
5901477170560

Kod produktu 20
Opryskiwacz ciśnieniowy 3L G73266 20

8L 43cm



GB Pressure sprayer
DE Drucksprüher
RU Ручной опрыскиватель
CZ Ruční tlakový postřikovač
SK Ručný tlakový postrekovač
HU Permetező kézi
RO Vermorel

Kod EAN
5901477100604

Kod produktu 6
Opryskiwacz 8l G73203 6

5L 43cm



GB Pressure sprayer
DE Drucksprüher
RU Ручной опрыскиватель
CZ Ruční tlakový postřikovač
SK Ručný tlakový postrekovač
HU Permetező kézi
RO Vermorel

Kod EAN
5901477100598

Kod produktu 6
Opryskiwacz 5l G73202 6

16L 48cm





GB Pressure sprayer
DE Drucksprüher
RU Ручной опрыскиватель
CZ Ruční tlakový postřikovač
SK Ručný tlakový postrekovač
HU Permetező kézi
RO Vermorel

Kod EAN
5901477100628

Kod produktu 1
Opryskiwacz 16l (niebieski) G73205 1

3L 43cm

GB Pressure sprayer
DE Drucksprüher
RU Ручной опрыскиватель
CZ Ruční tlakový postřikovač
SK Ručný tlakový postrekovač
HU Permetező kézi
RO Vermorel

Kod EAN
5901477165726

Kod produktu 6
Opryskiwacz ciśnieniowy ręczny 3L G73256 6

5L 43cm



GB Pressure sprayer
DE Drucksprüher
RU Ручной опрыскиватель
CZ Ruční tlakový postřikovač
SK Ručný tlakový postrekovač
HU Permetező kézi
RO Vermorel

Kod EAN
5901477165733

Kod produktu 6
Opryskiwacz ciśnieniowy ręczny 5L G73257 6

12V 85W 9000-10000rpm

21-23m/s 5-6m



GB Turbo spray nozzle for sprayer
DE Turbo-Sprühdüse für Sprüherat
RU Турбофорсунка для опрыскивателя
CZ Turbo rozprašovací tryska pro postřikovač
SK Turbo rozprašovací tryska pre postrekovač
HU Turbo permetező fúvóka
RO Duză turbo pentru pulverizator

Kod EAN
5903418300999

Kod produktu 10
Turbo dysza rozpylająca do opryskiwacza G73219 10

350mm



GB Pressure sprayer
DE Drucksprüher
RU Ручной опрыскиватель
CZ Ruční tlakový postřikovač
SK Ručný tlakový postrekovač
HU Permetező kézi
RO Vermorel

Kod EAN
5901477173479

Kod produktu 100
Opryskiwacz ciśnieniowy na butelkę (mosiężny) G73267 100

58-100cm



GB Telescopic handle
DE Teleskoplanze
RU Штанга телескопическая для опрыскивателя
CZ Násadec teleskopický
SK Násadec teleskopický
HU Teleszkópos lándzsa
RO Maner telescopic

Kod EAN
5901477100659

Kod produktu 1
Lanca teleskopowa 58cm-100cm stalowa G73208 1



GB Lance and the handle for sprayer
DE Lanze und der Griff für Sprayer
RU Копье и ручка для опрыскивателя
CZ Nástavec postřikovače
SK Nástavec postrekovače
HU Lándzsa
RO Lance



5901477100642

Lanca do opryskiwaczy 5L i 8L 44cm G73207 1

GB Lance and the handle for sprayer
DE Lanze und der Griff für Sprayer
RU Копье и ручка для опрыскивателя
CZ Nástavec postřikovače
SK Nástavec postrekovače
HU Lándzsa
RO Lance



5901477157295

Lanca i rączka do opryskiwaczy 5L i 8L G73213A 1



GB Shower spray gun
DE Spritzpistole
RU Пистолет для опрыскивателей
CZ Rozprašovací pistole na vodu
SK Rozprašovacia pištoľ na vodu
HU Locsoló pisztoly
RO Pistol pt. stropit



5901477100673

Rączka do lancy S-04 G73210 1

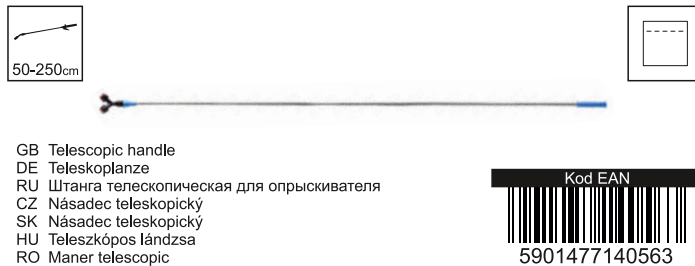

GB Telescopic handle
DE Teleskoplanze
RU Штанга телескопическая для опрыскивателя
CZ Násadec teleskopický
SK Násadec teleskopický
HU Teleszkópos lándzsa
RO Maner telescopic



5901477140563

Lanca teleskopowa 50-250cm do opryskiwaczy G73244 100

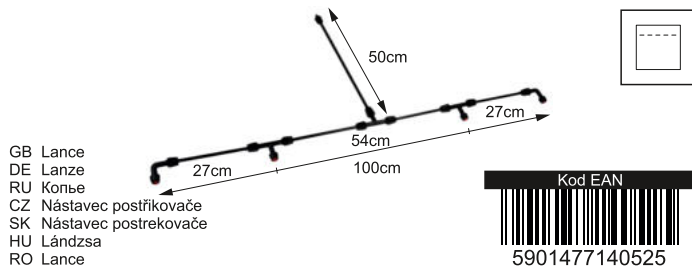

GB Lance
DE Lanze
RU Копье
CZ Nástavec postřikovače
SK Nástavec postrekovače
HU Lándzsa
RO Lance



5901477140525

Lanca opryskiwacza długa - 4 dysze G73240 100



GB Lance
DE Lanze
RU Копье
CZ Nástavec postřikovače
SK Nástavec postrekovače
HU Lándzsa
RO Lance



5901477140532

Lanca opryskiwacza ciśnieniowego długa 90cm G73241 150

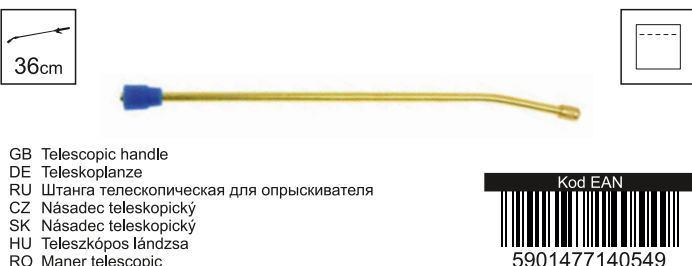

GB Telescopic handle
DE Teleskoplanze
RU Штанга телескопическая для опрыскивателя
CZ Násadec teleskopický
SK Násadec teleskopický
HU Teleszkópos lándzsa
RO Maner telescopic



5901477140549

Lanca mosiężna opryskiwacza ciśnieniowego 5-8L G73242 200

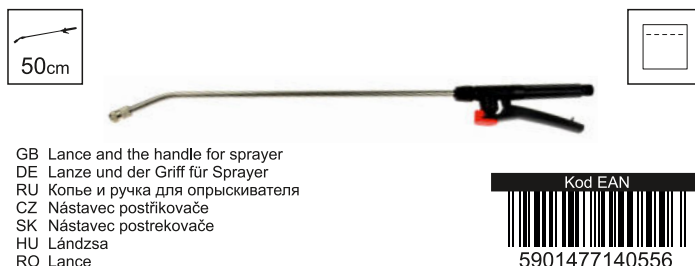

GB Lance and the handle for sprayer
DE Lanze und der Griff für Sprayer
RU Копье и ручка для опрыскивателя
CZ Nástavec postřikovače
SK Nástavec postrekovače
HU Lándzsa
RO Lance



5901477140556

Lanca metalowa opryskiwacza ciśnieniowego +rączka G73243 150



GB Straight nozzle for pressure sprayer
DE Sprühdüse für Drucksprüher
RU Распылитель на опрыскиватели
CZ Rozprašovací koncovka k postřikovači
SK Rozprašovacia koncovka k postrekovačmi
HU Porlasztó tömlővég eszétetöhöz
RO Doza pt. vermores



5901477165917

3szt. dysz do opryskiwacza akumulatorowego G73245 250



GB Herbicide shield
DE Sprühdeckel
RU Крышка распылителя
CZ Kryt postřikovače
SK Kryt postrekovača
HU Permetező szűkítő tölcser
RO Palnie pentru erbicidat



5901477157301

Oslona herbicydowa opryskiwacza G73246 200

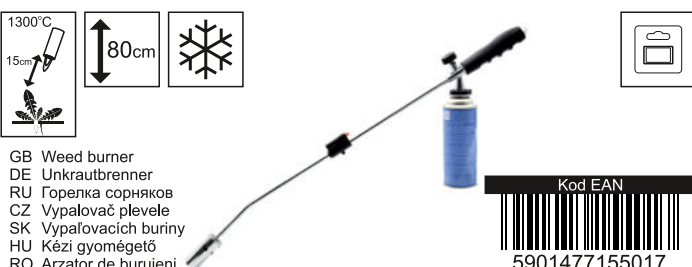

GB Weed burner
DE Unkrautbrenner
RU Горелка сорняков
CZ Vypalovač plevelu
SK Vypalovačích buriny
HU Kézi gyomégető
RO Arzator de buruieni



5901477155017

Palnik-wypalarka ogrodowa do chwastów G20035 12

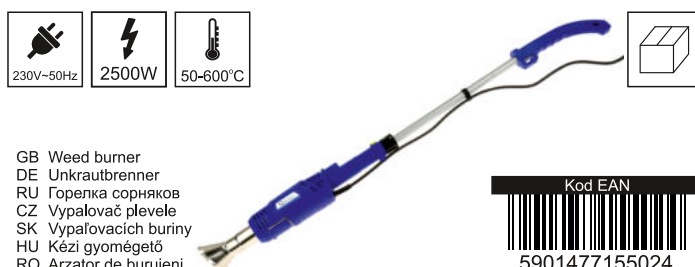

GB Weed burner
DE Unkrautbrenner
RU Горелка сорняков
CZ Vypalovač plevelu
SK Vypalovačích buriny
HU Kézi gyomégető
RO Arzator de buruieni



5901477155024

Opalarka - wypalarka do chwastów 230V G20036 10

Pompy do wody / Water Pumps



 6.5KM	3"
 MAX 3600/min	max 1000 l/min





GB Gasoline water pump
DE Pumpe mit verbrennungsmotor
RU Бензонасос
CZ Čerpadlo se spalovacím motorem
SK Čerpadlo so spaľovacím motorom
HU Robbanómotoros szivattyú
RO Pompa cu motor cu ardere internă



5901477126895

EKO Pompa spalinowa do wody, motopompa 3" **G81040** 1



 1.9KM	1"
 MAX 7000/min	max 400 l/min



GB Gasoline water pump
DE Pumpe mit verbrennungsmotor
RU Бензонасос
CZ Čerpadlo se spalovacím motorem
SK Čerpadlo so spaľovacím motorom
HU Robbanómotoros szivattyú
RO Pompa cu motor cu ardere internă



5901477115387

EKO Pompa spalinowa do wody, motopompa 1" **G81041** 1



 6.5KM	2"
 MAX 3600/min	max 600 l/min





GB Gasoline water pump
DE Pumpe mit verbrennungsmotor
RU Бензонасос
CZ Čerpadlo se spalovacím motorem
SK Čerpadlo so spaľovacím motorom
HU Robbanómotoros szivattyú
RO Pompa cu motor cu ardere internă



5901477135804

EKO Pompa spalinowa do wody, motopompa 2" **G81042** 1



 9 Teeth	 Diameter: 28mm
--	---



GB Water pump - adaptor for brush cutter
DE Wasserpumpe - Adapter für Freischneider
RU Водяной насос - адаптер для кусторезов
CZ Vodní pumpa - adaptér na křovinořez
SK Vodná pumpa - adaptér na křovinořez
HU Vízpumpa - adapter bozótvágohoz
RO Pompa de apa - adaptor pentru motocosita



5901477179099

EKO Pompa do wody – przystawka do kosy spalinowej **G81064D** 20



Wydajność: 30 m ³ /h	Obroty na min: 3600 RPM
Króćce przyłączeniowe: 2" (50mm)	Wysokość podnoszenia: 36 m



GB Belt-driven Transfer Water Pump
DE Riemengetriebene Transferwasserpumpe
RU Перекачивающий водяной насос с ремённым приводом
CZ Převodní vodní čerpadlo poháněné řemenem
SK Prevodové vodné čerpadlo poháňané remeňom
HU Szíjhajtású transzfer vízszivattyú
RO Pompă de apă de transfer acţionată de curea



GEKO Kod produktu **G81467** 1
Pompa do wody na pasek klinowy, motopompa 2"

Wydajność: 55 m ³ /h	Obroty na min: 3600 RPM
Króćce przyłączeniowe: 3" (75mm)	Wysokość podnoszenia: 36 m



GB Gasoline water pump
DE Pumpe mit verbrennungsmotor
RU Бензонасос
CZ Čerpadlo se spalovacím motorem
SK Čerpadlo so spaľovacím motorom
HU Robbanómotoros szivattyú
RO Pompa cu motor cu ardere internă



GEKO Kod produktu **G81468** 1
Pompa do wody na pasek klinowy, motopompa 3"

Wydajność: 80 m ³ /h	Obroty na min: 3600 RPM
Króćce przyłączeniowe: 4" (100mm)	Wysokość podnoszenia: 36 m



GB Belt-driven Transfer Water Pump
DE Riemengetriebene Transferwasserpumpe
RU Перекачивающий водяной насос с ремённым приводом
CZ Převodní vodní čerpadlo poháněné řemenem
SK Prevodové vodné čerpadlo poháňané remeňom
HU Szíjhajtású transzfer vízszivattyú
RO Pompă de apă de transfer acţionată de curea



GEKO Kod produktu **G81469** 1
Pompa do wody na pasek klinowy, motopompa 4"

230V-50Hz	400W
max 5.0 m ³ /h	1" 1-1/4" 1-1/2"



GB Dirty water submersible pump
DE Tauchmotorpumpe
RU Погружной насос
CZ Zatavovací čerpadlo
SK Zatašovacie čerpadlo
HU Bűvárszivattyú
RO Pompă pt. apă murdară



GEKO Kod produktu **G81401** 1
Pompa plastik z pływakiem do brudnej wody

230V-50Hz	550W
max 17000 l/h	2"
żeliwo	↑ max 8m



GB Submersible pump for dirty water and wastewater
DE Tauchpumpe für Schmutzwasser
RU Погружной насос для грязной воды
CZ Ponorné čerpadlo pro odpadní vody
SK Ponorné čerpadlo pre odpadové vody
HU Bűvárszivattyú szennyvíz
RO Pompă submersibilă pt. apă uzată

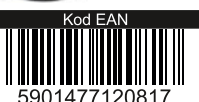

GEKO Kod produktu **G81402** 1
Pompa rozdr. WQD 10-8-0,55 do brudnej wody/czarna/

230V-50Hz	370W
max 6000 l/h	1"
żeliwo	



GB Water pump (Cast iron)
DE Wasserpumpe (Gusseisen)
RU Гидроустройный насос (Чугун)
CZ Ponorná čerpadla
SK Ponorné čerpadlá
HU Mélykútszivattyú
RO Pompa apa submersibila

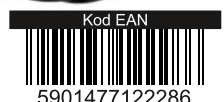

GEKO Kod produktu **G81403** 1
Pompa do wody QDX 0,37 GEKO żeliwo

max 6000 l/h	1"
	żeliwo



GB Water pump (Cast iron)
DE Wasserpumpe (Gusseisen)
RU Гидроструйный насос (Чугун)
CZ Ponorňá erpadla
SK Ponorňné erpadl
HU Mlyktszivatty
RO Pompa apa submersibila



Kod EAN
5906190200822

Pompa do wody QDX3-0.37 GEKO eliwo z plywakiem G81405 1

max 270 l/h	80m



GB WC sewage pump
DE WC Abwasserpumpe
RU WC насос для сточных вод
CZ WC erpadlo
SK WC erpadlo
HU Darls WC s hztartsi viztemel
RO Pompa pentru ape uzate



Kod EAN
5901477129599

Pompa do przepompowywania w WC z rozdrabniaczem G81419 1

max 17000 l/h	2"
	żeliwo
	max 8m



GB Submersible pump for dirty water and wastewater
DE Tauchpumpe fur Schmutzwasser
RU Погружной насос для грязной воды
CZ Ponorňné erpadlo pro odpadn vodu
SK Ponorňné erpadlo pre odpadov vodu
HU Bvrszivatty szennyvz
RO Pomp submersibil pt. ap uzat



Kod EAN
5901477122859

Pompa rozdr. WQD10-8-0.55 z plywakiem/do brudnej wody/ G81420 1

max 17000 l/h	2"
nikiel	max 8m



GB Dirty water submersible pump
DE Tauchmotorpumpe
RU Погружный насос
CZ Zatahovci erpadlo
SK Zatahovacie erpadlo
HU Bvrszivatty
RO Pomp pt. ap murdar



Kod EAN
5901477123566

Pompa rozdr. WQD 10-8-0,55 nikiel/do brudnej wody G81421 1

max 20000 l/h	2"
	żeliwo
	max 8m



GB Submersible pump for dirty water and wastewater
DE Tauchpumpe fur Schmutzwasser
RU Погружной насос для грязной воды
CZ Ponorňné erpadlo pro odpadn vodu
SK Ponorňné erpadlo pre odpadov vodu
HU Bvrszivatty szennyvz
RO Pomp submersibil pt. ap uzat



Kod EAN
5901477121944

Pompa rozdrabniacz z nożami tncymi G81423 1

max 17000 l/h	2"
żeliwo	max 8m



GB Dirty water submersible pump
DE Tauchmotorpumpe
RU Погружный насос
CZ Zatahovci erpadlo
SK Zatahovacie erpadlo
HU Bvrszivatty
RO Pomp pt. ap murdar



Kod EAN
5901477117510

Pompa rozdrab. WQD-10-8-0,55 do brudnej wody G81424 1

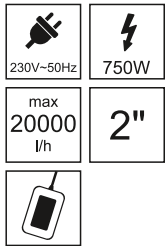

GB Submersible pump for dirty water and wastewater
 DE Tauchpumpe für Schmutzwasser
 RU Погружной насос для грязной воды
 CZ Ponorné čerpadlo pro odpadní vody
 SK Ponorné čerpadlo pre odpadové vody
 HU Búvárszivattyú szennyvíz
 RO Pompă submersibilă pt. apă uzată



Pompa do ścieków WQCD 0,75 z rozdrabniaczem(miedz. uzn.) G81425 1

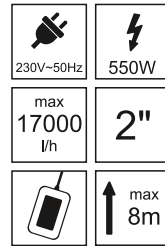

GB Dirty water submersible pump
 DE Tauchmotorpumpe
 RU Погружной насос
 CZ Zatahovací čerpadlo
 SK Zatahovacie čerpadlo
 HU Búvárszivattyú
 RO Pompă pt. apă murdară



Pompa do szamba WQD-nikiel pływak+wylącznik termiczny G81426 1



GB Submersible pump for dirty water and wastewater
 DE Tauchpumpe für Schmutzwasser
 RU Погружной насос для грязной воды
 CZ Ponorné čerpadlo pro odpadní vody
 SK Ponorné čerpadlo pre odpadové vody
 HU Búvárszivattyú szennyvíz
 RO Pompă submersibilă pt. apă uzată



Pompa do szamba WQD-rozdra. pływak+wylącznik termiczny G81427 1

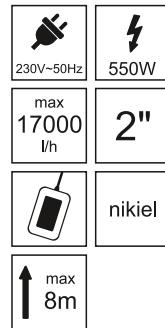

GB Dirty water submersible pump
 DE Tauchmotorpumpe
 RU Погружной насос
 CZ Zatahovací čerpadlo
 SK Zatahovacie čerpadlo
 HU Búvárszivattyú
 RO Pompă pt. apă murdară



Pompa rozdr. WQD10-8-0,55 nikiel z pływakiem/do brudnej wody/ G81428 1

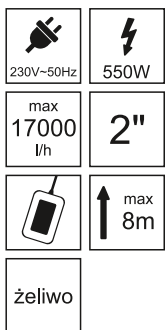

GB Submersible pump for dirty water and wastewater
 DE Tauchpumpe für Schmutzwasser
 RU Погружной насос для грязной воды
 CZ Ponorné čerpadlo pro odpadní vody
 SK Ponorné čerpadlo pre odpadové vody
 HU Búvárszivattyú szennyvíz
 RO Pompă submersibilă pt. apă uzată



Pompa do szamba z rozdr. WQD-055 + pływak G81429 1

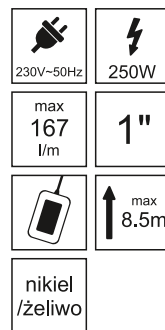

GB Dirty water submersible pump
 DE Tauchmotorpumpe
 RU Погружной насос
 CZ Zatahovací čerpadlo
 SK Zatahovacie čerpadlo
 HU Búvárszivattyú
 RO Pompă pt. apă murdară



Pompa do szamba WQD3-7-0.25 + pływak PREMIUM G81440 1

max 317 l/m	2"
nikiel /żeliwo	



max 334 l/m	2"
nikiel /żeliwo	



GB Dirty water submersible pump
DE Tauchmotorpumpe
RU Погружной насос
CZ Zatavovací čerpadlo
SK Zatahovacie čerpadlo
HU Búvárszivattyú
RO Pompă pt. apă murdară



Kod EAN
5901477148958

Pompa do szamba WQD8-8-0.55 PREMIUM Kod produktu G81441 1

GB Dirty water submersible pump
DE Tauchmotorpumpe
RU Погружной насос
CZ Zatavovací čerpadlo
SK Zatahovacie čerpadlo
HU Búvárszivattyú
RO Pompă pt. apă murdară



Kod EAN
5901477148965

Pompa do szamba WQD10-10-0.75 z plywakiem PREMIUM Kod produktu G81442 1

max 284 l/m	2"
nikiel /żeliwo	



max 384 l/m	2"
nikiel /żeliwo	



GB Dirty water submersible pump
DE Tauchmotorpumpe
RU Погружной насос
CZ Zatavovací čerpadlo
SK Zatahovacie čerpadlo
HU Búvárszivattyú
RO Pompă pt. apă murdară



Kod EAN
5901477148972

Pompa do szamba z mlynkiem 1.1KW PREMIUM Kod produktu G81445 1

GB Dirty water submersible pump
DE Tauchmotorpumpe
RU Погружной насос
CZ Zatavovací čerpadlo
SK Zatahovacie čerpadlo
HU Búvárszivattyú
RO Pompă pt. apă murdară



Kod EAN
5901477148989

Pompa do szamba z mlynkiem 1.5KW PREMIUM Kod produktu G81446 1

max 7500 l/h	1" 1-1/4" 1-1/2"



max 13000 l/h	1" 1-1/4" 1-1/2"



GB Dirty water submersible pump
DE Tauchmotorpumpe
RU Погружной насос
CZ Zatavovací čerpadlo
SK Zatahovacie čerpadlo
HU Búvárszivattyú
RO Pompă pt. apă murdară



Kod EAN
5901477148934

Pompa plastik do brudnej wody z plywakiem typ.2 Kod produktu G81453 4

GB Dirty water submersible pump
DE Tauchmotorpumpe
RU Погружной насос
CZ Zatavovací čerpadlo
SK Zatahovacie čerpadlo
HU Búvárszivattyú
RO Pompă pt. apă murdară



Kod EAN
5901477148941

Pompa Plastik do brudnej wody 750W z plywakiem BIG Kod produktu G81454 4

max 15000 l/h	1" 1-1/4" 1-1/2"



max 13000 l/h	1" 1-1/4" 1-1/2"



GB Dirty water submersible pump
DE Tauchmotorpumpe
RU Погружной насос
CZ Zatavovací čerpadlo
SK Zatahovacie čerpadlo
HU Búvárszivattyú
RO Pompă pt. apă murdară



Pompa plastik do brudnej wody 1100W Kod produktu **G81457** 4

GB Dirty water submersible pump
DE Tauchmotorpumpe
RU Погружной насос
CZ Zatavovací čerpadlo
SK Zatahovacie čerpadlo
HU Búvárszivattyú
RO Pompă pt. apă murdară



Pompa plastik do brudnej wody z wbudowanym pływakiem Kod produktu **G81459** 4

max 6000 l/h	1" 1-1/4" 1-1/2"



max 14000 l/h	1" 1-1/4" 1-1/2"



GB Dirty water submersible pump
DE Tauchmotorpumpe
RU Погружной насос
CZ Zatavovací čerpadlo
SK Zatahovacie čerpadlo
HU Búvárszivattyú
RO Pompă pt. apă murdară



Pompa płytkossąca do czystej wody z wyłącznikiem elektrodowym Kod produktu **G81462** 4

GB Dirty water submersible pump
DE Tauchmotorpumpe
RU Погружной насос
CZ Zatavovací čerpadlo
SK Zatahovacie čerpadlo
HU Búvárszivattyú
RO Pompă pt. apă murdară



Pompa zanurzeniowa z pływakiem do brudnej wody Kod produktu **G81463** 4

max 17000 l/h	max 8m



max 17000 l/h	



GB Dirty water submersible pump
DE Tauchmotorpumpe
RU Погружной насос
CZ Zatavovací čerpadlo
SK Zatahovacie čerpadlo
HU Búvárszivattyú
RO Pompă pt. apă murdară



Pompa do brudnej wody szamba WQD Nikiel Kod produktu **H00606** 1

GB Dirty water submersible pump
DE Tauchmotorpumpe
RU Погружной насос
CZ Zatavovací čerpadlo
SK Zatahovacie čerpadlo
HU Búvárszivattyú
RO Pompă pt. apă murdară



Pompa do szamba z rozdrabniaczem WQD NIKIEL z pływakiem Kod produktu **H00607** 1

max 20000 l/h	2"
	želiwo
max 20m	



max 6000 l/h	
max 8m	



GB Dirty water submersible pump
DE Tauchmotorpumpe
RU Погружной насос
CZ Zatahovací čerpadlo
SK Zatahovacie čerpadlo
HU Búvárszivattyú
RO Pompă pt. apă murdară



Kod EAN
5901477127885

Heidmann Kod produktu **Pompa rozdrabniacz z nożami tnącymi typ H H00610 1**

GB Water pump (Cast iron)
DE Wasserpumpe (Gusseisen)
RU Гидроструйный насос (Чугун)
CZ Ponorná čerpadla
SK Ponorné čerpadlá
HU Mélykútszivattyú
RO Pompa apa submersibila



Kod EAN
5901477143687

Heidmann Kod produktu **Pompa do wody QDX "Sito" Heidmann H00614 1**

max 5200 l/h	1"
	max 11m



max 8000 l/h	1"
	max 5m



GB Rain water pump with float
DE Regenwasserpumpe mit Schwimmer
RU Насос для дождевой воды с поплавком
CZ Čerpadlo na dešťovou vodu s plavákem
SK Čerpadlo na dažďovú vodu s plavákom
HU Esővíz szivattyú úszóval
RO Pompa de apa de ploaie cu flotór



Kod EAN
5901477194078

EKO Kod produktu **Pompa zatapialna z pływakiem do wody deszczowej G81464 4**

GB Plastic dirty water pump with float switch
DE Kunststoff-Schmutzwasserpumpe mit Schwimmer
RU Пластиковый насос для грязной воды с поплавком
CZ Plastové čerpadlo na znečištěnou vodu s plavákem
SK Plastové čerpadlo na znečistenú vodu s plavákom
HU Műanyag szennyvízszivattyú úszókapcsolóval
RO Pompă din plastic pentru apă murdară cu plutitor



Kod EAN
5901477199769

EKO Kod produktu **Pompa plastik MINI z pływakiem do brudnej wody G81458 4**

max 12500 l/h	1" 1 1/4" 1 1/2"
	max 7m



max 12500 l/h	1" 1 1/4" 1 1/2"
	max 7m



GB Plastic dirty water pump with float switch
DE Kunststoff-Schmutzwasserpumpe mit Schwimmer
RU Пластиковый насос для грязной воды с поплавком
CZ Plastové čerpadlo na znečištěnou vodu s plavákem
SK Plastové čerpadlo na znečistenú vodu s plavákom
HU Műanyag szennyvízszivattyú úszókapcsolóval
RO Pompă din plastic pentru apă murdară cu plutitor



Kod EAN
5901477198908

EKO Kod produktu **Pompa plastik z pływakiem płytkossąca do wody czystej i brudnej G81475 4**

GB Pump with float switch for clean and dirty water
DE Pumpe mit Schwimmer für Klar- und Schmutzwasser
RU Насос с поплавком для чистой и грязной воды
CZ Čerpadlo s plavákem na čistou a znečištěnou vodu
SK Čerpadlo s plavákom na čistú a znečistenú vodu
HU Szivattyú úszókapcsolóval tiszta és szennyezett vízhez
RO Pompă cu plutitor pentru apă curată și murdară



Kod EAN
5901477198915

EKO Kod produktu **Pompa z pływakiem płytkossąca do wody czystej i brudnej G81477 4**



GB Capacitor WQD
DE Kondensator für Taucherpumpe
RU Конденсатор
CZ Kondenzátor
SK Kondenzátor
HU Kondenzátor
RO Condensator



5901477167065

Kod produktu **Kondensator do pompy rozdrabniacz WQD 10-8-0,55 G81449E 100**



GB Float switch for WQD10-8-055
DE Schwimmerschalter für Taucherpumpe
RU Плавучий выключатель
CZ Plovoucí spínač
SK Plávajúce spínač
HU Úszókapcsoló
RO Comutator plutitor



5901477165924

Kod produktu **Pływak do pompy rozdrabniacz WQD 10-8-0,55(G81420) G81449 100**



GB Body for WQD10-8-055
DE Pumpengehäuse für Taucherpumpe
RU Крышка
CZ Kryt čerpadla
SK Kryt čerpadla
HU Szivattyúház
RO Carcasa pompa



5901477167027

Kod produktu **Obudowa do pompy rozdrabniacz WQD 10-8-0,55 G81449A 10**



GB Gaskets, rubber bands
DE Flachdichtungen, gummibänder
RU Уплотняющая прокладка, резинка
CZ Těsnění, pryžové pásky
SK Tesnenie, gumené pásky
HU Csúszótömítés
RO Garnituri, benzi de cauciuc



5901477167058

Kod produktu **Uszczelniacze, recepturki do pomp WQD 10-8-0,55 G81449D 100**



GB Basis for WQD 10-8-0,55
DE Pumpenfußplatte
RU Плита основания
CZ Základna čerpadla
SK Základňa čerpadlá
HU Szivattyú láb
RO Baza pompei



5901477167041

Kod produktu **Podstawa do pompy nikiel WQD 10-8-0,55 G81449C 25**



GB Power cord
DE Netzkabel
RU Шнур питания
CZ Napájecí kabel
SK Napájací kábel
HU Tápkábel
RO Cablul de alimentare



5901477165931

Kod produktu **Przewód zasilający do pompy z rozdrabniaczem G81449F 25**

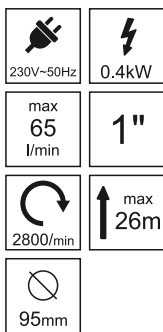

GB Water pump
DE Unterwasserpumpe
RU Погружной насос
CZ Ponorná čerpadla
SK Ponorné čerpadlá
HU Mélykútszivattyú
RO Pompa apa submersibila



5901477115547

Kod produktu **Pompa głębinowa QJD-26/6-0,4 G81406 1**

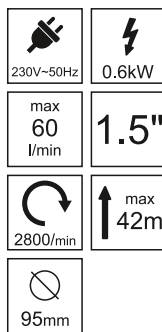

GB Water pump
DE Unterwasserpumpe
RU Погружной насос
CZ Ponorná čerpadla
SK Ponorné čerpadlá
HU Mélykútszivattyú
RO Pompa apa submersibila



5901477115035

Kod produktu **Pompa głębinowa QJD2-42/10-0,6 G81408 1**

 230V-50Hz	 1.1kW
max 90 l/min	1.5"
 2800/min	max 62m
 95mm	



 230V-50Hz	 1.5kW
max 90 l/min	1.5"
 2800/min	max 62m
 95mm	



GB Water pump
DE Unterwasserpumpe
RU Погружной насос
CZ Ponorná čerpadla
SK Ponorné čerpadlá
HU Mélykútszivattyú
RO Pompa apa submersibila

Kod EAN



5901477114991

 **Pompa głębinowa QJD2-62/15-1.1** Kod produktu **G81409**  **1**





GB Water pump
DE Unterwasserpumpe
RU Погружной насос
CZ Ponorná čerpadla
SK Ponorné čerpadlá
HU Mélykútszivattyú
RO Pompa apa submersibila

Kod EAN





5901477114083

 **Pompa głębinowa QJD2-62/15-1.5** Kod produktu **G81410**  **1**

 230V-50Hz	 0.75kW
max 55 l/min	1"
 2800/min	max 100m
 100mm	



 230V-50Hz	 280W
max 0.9 m³/h	3/4"
max 16m	



GB Water pump
DE Unterwasserpumpe
RU Погружной насос
CZ Ponorná čerpadla
SK Ponorné čerpadlá
HU Mélykútszivattyú
RO Pompa apa submersibila

Kod EAN



5901477125492

 **Pompa głębinowa śrubowa 750W** Kod produktu **G81417**  **1**



GB Membrane deep well water pump
DE Tauchmotorpumpe
RU Погружной насос
CZ Zatahovací čerpadlo
SK Zatahovacie čerpadlo
HU Búvárszivattyú
RO Pompa pt. apa cu membrana

Kod EAN





5901477166617

 **Pompa głębinowa do wody (typ nurek)** Kod produktu **G81414**  **6**

 230V-50Hz	 460W
max 1080 l/h	3/4"
max 60m	



 230V-50Hz	 280W
max 0.9 m³/h	3/4"
max 60m	



GB Membrane deep well water pump
DE Tauchmotorpumpe
RU Погружной насос
CZ Zatahovací čerpadlo
SK Zatahovacie čerpadlo
HU Búvárszivattyú
RO Pompa pt. apa cu membrana

Kod EAN



5901477128837

 **Pompa głębinowa VMP60 typ. nurek** Kod produktu **H00611**  **6**

GB Membrane deep well water pump
DE Tauchmotorpumpe
RU Погружной насос
CZ Zatahovací čerpadlo
SK Zatahovacie čerpadlo
HU Búvárszivattyú
RO Pompa pt. apa cu membrana

Kod EAN



5901477125515

 **Pompa do wody nurek dolnosący** Kod produktu **G81422**  **6**

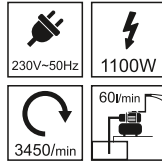
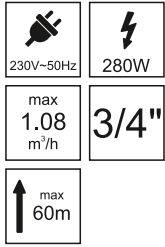

GB Membrane deep well water pump
DE Tauchmotorpumpe
RU Погружной насос
CZ Zatahovací čerpadlo
SK Zatahovacie čerpadlo
HU Búvárszivattyú
RO Pompa pt. apa cu membrana



Kod EAN
5901477153389

Pompa głębinowa typu nurek górnoścaga PREMIUM G81455 6

GB Self-priming pump
DE Selbstansaugende Pumpe
RU Самовсасывающий насос
CZ Samonasávací čerpadlo
SK Samonasávacie čerpadlo
HU Önfelszívó szivattyú
RO Pompă de auto-amorsare



Kod EAN
5901477136450

Pompa hydroforowa JET100S 1100W G81500 1

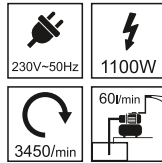
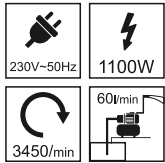

GB Self-priming pump
DE Selbstansaugende Pumpe
RU Самовсасывающий насос
CZ Samonasávací čerpadlo
SK Samonasávacie čerpadlo
HU Önfelszívó szivattyú
RO Pompă de auto-amorsare



Kod EAN
5901477136467

Pompa hydroforowa JS100 1100W G81501 1

GB Self-priming pump
DE Selbstansaugende Pumpe
RU Самовсасывающий насос
CZ Samonasávací čerpadlo
SK Samonasávacie čerpadlo
HU Önfelszívó szivattyú
RO Pompă de auto-amorsare



Kod EAN
5901477139468

Zestaw hydroforowy 24L JET100S G81511 1

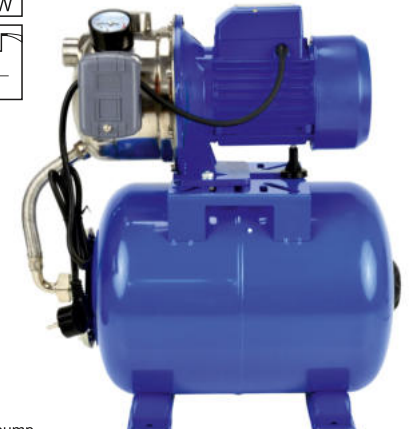
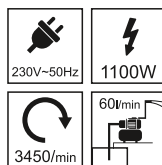
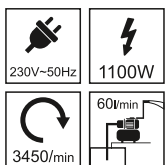

GB Self-priming pump
DE Selbstansaugende Pumpe
RU Самовсасывающий насос
CZ Samonasávací čerpadlo
SK Samonasávacie čerpadlo
HU Önfelszívó szivattyú
RO Pompă de auto-amorsare



Kod EAN
5901477139475

Zestaw hydroforowy 50l JET100S G81512 1

GB Self-priming pump
DE Selbstansaugende Pumpe
RU Самовсасывающий насос
CZ Samonasávací čerpadlo
SK Samonasávacie čerpadlo
HU Önfelszívó szivattyú
RO Pompă de auto-amorsare



Kod EAN
5901477139482

Zestaw hydroforowy 24L Js100 G81513 1

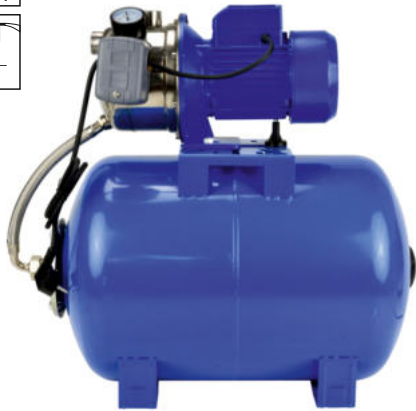
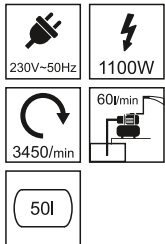

GB Self-priming pump
DE Selbstansaugende Pumpe
RU Самовсасывающий насос
CZ Samonasávací čerpadlo
SK Samonasávacie čerpadlo
HU Őnfelszívó szivattyú
RO Pompă de auto-amorsare



5901477139499

Zestaw hydroforowy 50L Js100 Kod produktu: **G81514** 1



GB Pressure tank
DE Drucktank
RU Напорный бак
CZ Tlaková nádoba
SK Tlaková nádoba
HU Nyomástartály
RO Rezervor de presiune



5901477139666

Zbiornik hydroforowy przeponowy 24L Kod produktu: **G81520** 1



GB Pressure tank
DE Drucktank
RU Напорный бак
CZ Tlaková nádoba
SK Tlaková nádoba
HU Nyomástartály
RO Rezervor de presiune



5901477139673

Zbiornik hydroforowy przeponowy 50L Kod produktu: **G81521** 1



GB Pressure tank
DE Drucktank
RU Напорный бак
CZ Tlaková nádoba
SK Tlaková nádoba
HU Nyomástartály
RO Rezervor de presiune



5901477139680

Zbiornik hydroforowy przeponowy 100L Kod produktu: **G81522** 1



GB Valve
DE Ventil
RU Клапан
CZ Ventil
SK Ventil
HU Szep
RO Supapă



5901477139734

Wyjście tłoczne 5-drożne (zawór) hydroforu Kod produktu: **G81527** 100



GB Flexible Hose for Water Pump
DE Flexibler Schlauch für Wasserpumpe
RU Гибкий шланг для водяного насоса
CZ Flexibilní hadice pro vodní čerpadlo
SK Flexibilná hadica pre vodné čerpadlo
HU Rugalmas tömlő vízszivattyúhoz
RO Furtun flexibil pentru pompa de apa



5901477139697

Wąż antywibracyjny 50cm z kolanem hydroforu Kod produktu: **G81523** 1



GB Manometer
DE Manometer
RU Манометр для пресса
CZ Manometr do lisu
SK Manometer do lisu
HU Manométer
RO Manometru



5901477139758

Manometr hydroforu 0-12 bar Kod produktu: **G81529** 200



GB Flexible Hose for Water Pump
DE Flexibler Schlauch für Wasserpumpe
RU Гибкий шланг для водяного насоса
CZ Flexibilní hadice pro vodní čerpadlo
SK Flexibilná hadica pre vodné čerpadlo
HU Rugalmas tömlő vízszivattyúhoz
RO Furtun flexibil pentru pompa de apa



5901477139710

Wąż antywibracyjny 70cm z kolanem hydroforu Kod produktu: **G81525** 1



GB Flexible Hose for Water Pump
 DE Flexibler Schlauch für Wasserpumpe
 RU Гибкий шланг для водяного насоса
 CZ Flexibilní hadice pro vodní čerpadlo
 SK Flexibilná hadica pre vodné čerpadlo
 HU Rugalmas tömlő vízszivattyúhoz
 RO Furtun flexibil pentru pompa de apa



5901477139703

Wąż antywibracyjny 60cm z kolanem hydroforu Kod produktu: **G81524** 1



GB Flexible Hose for Water Pump
 DE Flexibler Schlauch für Wasserpumpe
 RU Гибкий шланг для водяного насоса
 CZ Flexibilní hadice pro vodní čerpadlo
 SK Flexibilná hadica pre vodné čerpadlo
 HU Rugalmas tömlő vízszivattyúhoz
 RO Furtun flexibil pentru pompa de apa



5901477139727

Wąż antywibracyjny 80cm z kolanem hydroforu Kod produktu: **G81526** 1

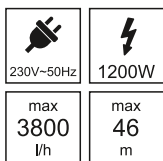

GB Jet pump
 DE Gartenpumpe
 RU Насос садовый
 CZ Zahradní čerpadlo
 SK Záhradné čerpadlo
 HU Kerti szivattyúhoz
 RO Pompa apa



5901477125522

Pompa ogrodowa do wody 1200W Kod produktu: **G81435** 2



GB Pressure switch
 DE Druckschalter
 RU Дифференциальный манометр
 CZ Tlakový spínač
 SK Tlakový spínač
 HU Nyomáskapcsoló
 RO Presostat



5901477139741

Wyłącznik ciśnieniowy hydroforowy 1/4" Kod produktu: **G81528** 50

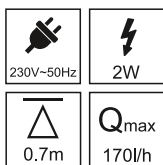

GB Garden pump
 DE Gartenpumpe
 RU Садовый насос
 CZ Zahradní čerpadlo
 SK Záhradné čerpadlo
 HU Kerti szivattyú
 RO Pompă de grădină



5901477155192

Pompka solarna do oczka wodnego 2W Kod produktu: **G81471** 10

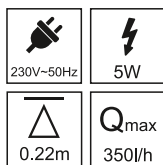

GB Garden pump
 DE Gartenpumpe
 RU Садовый насос
 CZ Zahradní čerpadlo
 SK Záhradné čerpadlo
 HU Kerti szivattyú
 RO Pompă de grădină



5901477155208

Pompa solarna do oczka wodnego 5W Kod produktu: **G81472** 16

Weże i akcesoria ogrodowe

/ Garden Hoses and accessories



GB Automatic garden hose reel
 DE Automatischer Gartenschlauchaufroller
 RU Автоматическая катушка с садовым шлангом
 CZ Automatický naviják se zahradní hadicí
 SK Automatický naviják so záhradnou hadicou
 HU Automata kerti tömlődob
 RO Tambur automat cu furtun de grădină



Zwijacz automatyczny z wężem ogrodowym 1/2" 25m BRASS-LINE T07295 1



GB Automatic garden hose reel
 DE Automatischer Gartenschlauchaufroller
 RU Автоматическая катушка с садовым шлангом
 CZ Automatický naviják se zahradní hadicí
 SK Automatický naviják so záhradnou hadicou
 HU Automata kerti tömlődob
 RO Tambur automat cu furtun de grădină



Zwijacz automatyczny z wężem ogrodowym 1/2" 35m BRASS-LINE T07296 1



GB Automatic garden hose reel
 DE Automatischer Gartenschlauchaufroller
 RU Автоматическая катушка с садовым шлангом
 CZ Automatický naviják se zahradní hadicí
 SK Automatický naviják so záhradnou hadicou
 HU Automata kerti tömlődob
 RO Tambur automat cu furtun de grădină



Zwijacz automatyczny z wężem ogrodowym 1/2" 20m SKY-LINE G72980 1



GB Automatic garden hose reel
 DE Automatischer Gartenschlauchaufroller
 RU Автоматическая катушка с садовым шлангом
 CZ Automatický naviják se zahradní hadicí
 SK Automatický naviják so záhradnou hadicou
 HU Automata kerti tömlődob
 RO Tambur automat cu furtun de grădină



Zwijacz automatyczny z wężem ogrodowym 1/2" 30m SKY-LINE G72981 1

1/2" 30m
1/2" 50m



GB Drip hose
DE Tropfschlauch
RU Капельный шланг
CZ Kapací hadice
SK Kvarkácia hadica
HU Locsolótömlő
RO Picurare furtun

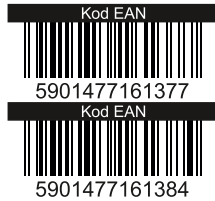

GEKO	Kod produktu		
Wąż nawadniający kroplujący 1/2" 30m	G70071	6	
Wąż nawadniający kroplujący 1/2" 50m	G70072	2	

1/2" 10m
3/4"



GB Soaker hose
DE Einweichen Schlauch
RU Спринклерный шланг
CZ Hadicový zavlažovač
SK Hadicový zavlažovač
HU Esőztétőtömlő
RO Furtun de aspersoare



GEKO	Kod produktu		
Mgielka ogrodowa - wąż + zraszacze do nawadniania 10m	G70075	50	

1" 10m
1" 20m
1" 30m



GB Garden hose
DE Gartenschlauch
RU Садовый шланг
CZ Zahradní hadice
SK Záhradné hadice
HU Kerti tömlő
RO Furtun de gradina



GEKO	Kod produktu		
Wąż ogrodowy 4 Warstwowy 1" 10m GEKO NEW	G73780	55	
Wąż ogrodowy 4 Warstwowy 1" 20m GEKO NEW	G73781	55	
Wąż ogrodowy 4 Warstwowy 1" 30m GEKO NEW	G73789	45	

1/2" 20m
1/2" 30m
1/2" 50m



GB Garden hose
DE Gartenschlauch
RU Садовый шланг
CZ Zahradní hadice
SK Záhradné hadice
HU Kerti tömlő
RO Furtun de gradina

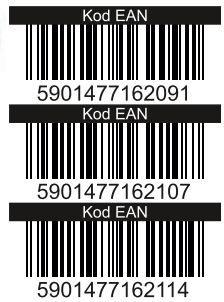

GEKO	Kod produktu		
Wąż ogrodowy 4 Warstwowy 1/2" 20m GEKO NEW	G73782	198	
Wąż ogrodowy 4 Warstwowy 1/2" 30m GEKO NEW	G73783	154	
Wąż ogrodowy 4 Warstwowy 1/2" 50m GEKO NEW	G73785	108	

3/4" 20m
3/4" 30m
3/4" 50m



GB Garden hose
DE Gartenschlauch
RU Садовый шланг
CZ Zahradní hadice
SK Záhradné hadice
HU Kerti tömlő
RO Furtun de gradina



GEKO	Kod produktu		
Wąż ogrodowy 4 Warstwowy 3/4" 20m GEKO NEW	G73786	117	
Wąż ogrodowy 4 Warstwowy 3/4" 30m GEKO NEW	G73787	88	
Wąż ogrodowy 4 Warstwowy 3/4" 50m GEKO NEW	G73788	45	

1/2" 20m
1/2" 30m
1/2" 50m



GB Garden hose
DE Gartenschlauch
RU Садовый шланг
CZ Zahradní hadice
SK Záhradné hadice
HU Kerti tömlő
RO Furtun de gradina



GEKO	Kod produktu		
Wąż ogrodowy wzmacniany BLACK&RED 1/2" 20m	G73692	132	
Wąż ogrodowy wzmacniany BLACK&RED 1/2" 30m	G73693	110	
Wąż ogrodowy wzmacniany BLACK&RED 1/2" 50m	G73694	81	



3/4" 20m
 3/4" 30m
 3/4" 50m

Kod EAN
 5901477157011
 Kod EAN
 5901477157028
 Kod EAN
 5901477157035

GB Garden hose
 DE Gartenschlauch
 RU Садовый шланг
 CZ Zahradní hadice
 SK Záhradné hadice
 HU Kerti tömlő
 RO Furtun de gradina

Kod produktu		
Wąż ogrodowy wzmacniany BLACK&RED 3/4" 20m	G73695	117
Wąż ogrodowy wzmacniany BLACK&RED 3/4" 30m	G73696	88
Wąż ogrodowy wzmacniany BLACK&RED 3/4" 50m	G73697	45



1" 10m
 1" 20m
 1" 30m

Kod EAN
 5901477189029
 Kod EAN
 5901477157042
 Kod EAN
 5901477157059

GB Garden hose
 DE Gartenschlauch
 RU Садовый шланг
 CZ Zahradní hadice
 SK Záhradné hadice
 HU Kerti tömlő
 RO Furtun de gradina

Kod produktu		
Wąż ogrodowy wzmacniany BLACK&RED 1" 10m	G73691	55
Wąż ogrodowy wzmacniany BLACK&RED 1" 20m	G73698	55
Wąż ogrodowy wzmacniany BLACK&RED 1" 30m	G73699	45



3/4"

GB Fittings for garden hose
 DE Armaturen für Gartenschlauch
 RU Арматура для поливочных шлангов
 CZ Adaptér na kohoutek
 SK Adaptér na kohútik
 HU Locsolótömlő csatlakozó
 RO Conectori furtun gradina

Kod EAN
 5901477118074

Kod produktu
 Prziłącze na kran 3/4" BLUE LINE G73020 1000



1"

GB Fittings for garden hose
 DE Armaturen für Gartenschlauch
 RU Арматура для поливочных шлангов
 CZ Adaptér na kohoutek
 SK Adaptér na kohútik
 HU Locsolótömlő csatlakozó
 RO Conectori furtun gradina

Kod EAN
 5901477124297

Kod produktu
 Prziłącze na kran 1" z red.3/4 G73021 500



3/4"

GB Fittings for garden hose
 DE Armaturen für Gartenschlauch
 RU Арматура для поливочных шлангов
 CZ Adaptér na kohoutek
 SK Adaptér na kohútik
 HU Locsolótömlő csatlakozó
 RO Conectori furtun gradina

Kod EAN
 5901477118081

Kod produktu
 Prziłącze na kran 3/4 z red.1/2 BLUE LINE G73022 1000



1"

GB Fittings for garden hose
 DE Armaturen für Gartenschlauch
 RU Арматура для поливочных шлангов
 CZ Adaptér na kohoutek
 SK Adaptér na kohútik
 HU Locsolótömlő csatlakozó
 RO Conectori furtun gradina

Kod EAN
 5901477124280

Kod produktu
 Prziłącze na kran 1" BLUE LINE G73023 1000



3/4"

GB Fittings for garden hose
 DE Armaturen für Gartenschlauch
 RU Арматура для поливочных шлангов
 CZ Adaptér na kohoutek
 SK Adaptér na kohútik
 HU Locsolótömlő csatlakozó
 RO Conectori furtun gradina

Kod EAN
 5901477118067

Kod produktu
 Wkrętka do urz.zrasz.3/4gwint BLUE LINE G73025 1000

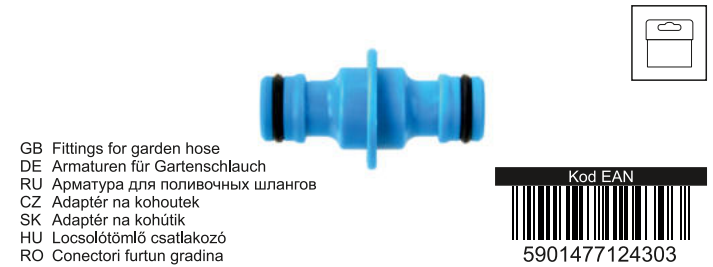

GB Fittings for garden hose
 DE Armaturen für Gartenschlauch
 RU Арматура для поливочных шлангов
 CZ Adaptér na kohoutek
 SK Adaptér na kohútik
 HU Locsolótömlő csatlakozó
 RO Conectori furtun gradina

Kod EAN
 5901477124303

Kod produktu
 Nypel do szybkozłączek G73026 1000



GB Fittings for garden hose
 DE Armaturen für Gartenschlauch
 RU Арматура для поливочных шлангов
 CZ Adaptér na kohoutek
 SK Adaptér na kohútik
 HU Locsolótömlő csatlakozó
 RO Conectori furtun gradina

Kod EAN
 5901477124310

Kod produktu
 Trójnik na szybkozłączki G73027 500



1/2"

GB Fittings for garden hose
 DE Armaturen für Gartenschlauch
 RU Арматура для поливочных шлангов
 CZ Adaptér na kohoutek
 SK Adaptér na kohútik
 HU Locsolótömlő csatlakozó
 RO Conectori furtun gradina

Kod EAN
 5901477118111

Kod produktu
 Szybkozłączka 1/2" BLUE LINE G73030 500

1/2"



GB Fittings for garden hose
DE Armaturen für Gartenschlauch
RU Арматура для поливочных шлангов
CZ Adaptér na kohoutek
SK Adaptér na kohútik
HU Locsolótömlő csatlakozó
RO Conectori furtun gradina

Kod EAN
5901477118104

Kod produktu 
Szybkozłączka 1/2"/blister BLUE LINE G73030B 200

1/2" STOP



GB Fittings for garden hose
DE Armaturen für Gartenschlauch
RU Арматура для поливочных шлангов
CZ Adaptér na kohoutek
SK Adaptér na kohútik
HU Locsolótömlő csatlakozó
RO Conectori furtun gradina

Kod EAN
5901477118135

Kod produktu 
Szybkozłączka 1/2" ze stopem G73031 500

1/2" STOP



GB Fittings for garden hose
DE Armaturen für Gartenschlauch
RU Арматура для поливочных шлангов
CZ Adaptér na kohoutek
SK Adaptér na kohútik
HU Locsolótömlő csatlakozó
RO Conectori furtun gradina

Kod EAN
5901477118128

Kod produktu 
Szybkozłączka 1/2" ze stopem/blister BLUE LINE G73031B 200

3/4"



GB Fittings for garden hose
DE Armaturen für Gartenschlauch
RU Арматура для поливочных шлангов
CZ Adaptér na kohoutek
SK Adaptér na kohútik
HU Locsolótömlő csatlakozó
RO Conectori furtun gradina

Kod EAN
5901477118159

Kod produktu 
Szybkozłączka 3/4 BLUE LINE G73032 400

3/4"



GB Fittings for garden hose
DE Armaturen für Gartenschlauch
RU Арматура для поливочных шлангов
CZ Adaptér na kohoutek
SK Adaptér na kohútik
HU Locsolótömlő csatlakozó
RO Conectori furtun gradina

Kod EAN
5901477118142

Kod produktu 
Szybkozłączka 3/4"/blister BLUE LINE G73032B 240

3/4" STOP



GB Fittings for garden hose
DE Armaturen für Gartenschlauch
RU Арматура для поливочных шлангов
CZ Adaptér na kohoutek
SK Adaptér na kohútik
HU Locsolótömlő csatlakozó
RO Conectori furtun gradina

Kod EAN
5901477118166

Kod produktu 
Szybkozłączka 3/4 ze stopem BLUE LINE G73033 500

3/4" STOP



GB Fittings for garden hose
DE Armaturen für Gartenschlauch
RU Арматура для поливочных шлангов
CZ Adaptér na kohoutek
SK Adaptér na kohútik
HU Locsolótömlő csatlakozó
RO Conectori furtun gradina

Kod EAN
5901477118173

Kod produktu 
Szybkozłączka 3/4" ze stopem blister BLUE LINE G73033B 240

1/2"



GB Fittings for garden hose
DE Armaturen für Gartenschlauch
RU Арматура для поливочных шлангов
CZ Adaptér na kohoutek
SK Adaptér na kohútik
HU Locsolótömlő csatlakozó
RO Conectori furtun gradina

Kod EAN
5901477118180

Kod produktu 
Reparator do węża 1/2 BLUE LINE G73035 500

3/4"



GB Fittings for garden hose
DE Armaturen für Gartenschlauch
RU Арматура для поливочных шлангов
CZ Adaptér na kohoutek
SK Adaptér na kohútik
HU Locsolótömlő csatlakozó
RO Conectori furtun gradina

Kod EAN
5901477118210

Kod produktu 
Reparator do węża 3/4 BLUE LINE G73036 500

1/2"



GB Fittings for garden hose
DE Armaturen für Gartenschlauch
RU Арматура для поливочных шлангов
CZ Adaptér na kohoutek
SK Adaptér na kohútik
HU Locsolótömlő csatlakozó
RO Conectori furtun gradina

Kod EAN
5901477118197

Kod produktu 
Reparator do węża 1/2"/blister BLUE LINE G73037 240

3/4"



GB Fittings for garden hose
DE Armaturen für Gartenschlauch
RU Арматура для поливочных шлангов
CZ Adaptér na kohoutek
SK Adaptér na kohútik
HU Locsolótömlő csatlakozó
RO Conectori furtun gradina

Kod EAN
5901477129971

Kod produktu 
Reparator do węża 3/4"/blister BLUE LINE G73038 240

1/2" 3/4"



GB Fittings for garden hose
DE Armaturen für Gartenschlauch
RU Арматура для поливочных шлангов
CZ Adaptér na kohoutek
SK Adaptér na kohútik
HU Locsolótömlő csatlakozó
RO Conectori furtun gradina

Kod EAN
5901477175718

Kod produktu 
Reparator do węża 1/2"-3/4" BLUE LINE G73039 500



GB Fittings for garden hose
DE Armaturen für Gartenschlauch
RU Арматура для поливочных шлангов
CZ Adaptér na kohoutek
SK Adaptér na kohútik
HU Locsolótömlő csatlakozó
RO Conectori furtun gradina



Kod EAN
5901477118029

Dysza zraszająca z regulacją/blister BLUE LINE G73040 200



GB Fittings for garden hose
DE Armaturen für Gartenschlauch
RU Арматура для поливочных шлангов
CZ Adaptér na kohoutek
SK Adaptér na kohútik
HU Locsolótömlő csatlakozó
RO Conectori furtun gradina



Kod EAN
5901477118036

Dysza zraszająca z regulacją BLUE LINE G73041 400

1/2"



GB Hose nozzle, tap adaptor
DE Bewässerungs Spritz und Anschlusset
RU Набор поливочный
CZ Sprcha zahradní
SK Sprcha záhradné
HU Kerti locsoló
RO Stropitor



Kod EAN
5901477175725

Komplet 4-elem. 1/2" do zraszania TPR LINE G73042 80

3/4"



GB Hose nozzle, tap adaptor
DE Bewässerungs Spritz und Anschlusset
RU Набор поливочный
CZ Sprcha zahradní
SK Sprcha záhradné
HU Kerti locsoló
RO Stropitor



Kod EAN
5901477175732

Kpl.4-elem. 3/4" do zraszania TPR LINE G73043 80

1/2"



GB Hose nozzle, tap adaptor
DE Bewässerungs Spritz und Anschlusset
RU Набор поливочный
CZ Sprcha zahradní
SK Sprcha záhradné
HU Kerti locsoló
RO Stropitor



Kod EAN
5901477118043

Kpl.4-elem. 1/2" do zraszania/blister BLUE LINE G73047 80

3/4"



GB Hose nozzle, tap adaptor
DE Bewässerungs Spritz und Anschlusset
RU Набор поливочный
CZ Sprcha zahradní
SK Sprcha záhradné
HU Kerti locsoló
RO Stropitor



Kod EAN
5901477118050

Kpl.4-elem. 3/4" do zraszania/blister BLUE LINE G73048 80



GB Sprinkling gun
DE Spritzpistole
RU Оросительный пистолет
CZ Postřikovací pistole
SK Postrekovacie pistole
HU Öntöző pisztoly
RO Pistol pt. pulverizare



Kod EAN
5901477124006

Pistolet metal. z regulacją PROF1 G73000 48



GB Sprinkling gun
DE Spritzpistole
RU Оросительный пистолет
CZ Postřikovací pistole
SK Postrekovacie pistole
HU Öntöző pisztoly
RO Pistol pt. pulverizare



Kod EAN
5901477124013

Pistolet plastik.7-funk.BLUE LINE GEKO G73008 48



GB Sprinkling gun
DE Spritzpistole
RU Оросительный пистолет
CZ Postřikovací pistole
SK Postrekovacie pistole
HU Öntöző pisztoly
RO Pistol pt. pulverizare



Kod EAN
5901477117985

Pistolet 8-funk. srebrny,r.guma G73009 48



GB Sprinkling gun
DE Spritzpistole
RU Оросительный пистолет
CZ Postřikovací pistole
SK Postrekovacie pistole
HU Öntöző pisztoly
RO Pistol pt. pulverizare



Kod EAN
5901477176760

Pistolet ogrodowy mosiężny 2-funkc. regulowany G73012 36



GB Sprinkling gun
DE Spritzpistole
RU Оросительный пистолет
CZ Postřikovací pistole
SK Postrekovacie pistole
HU Öntöző pisztoly
RO Pistol pt. pulverizare



Kod EAN
5901477194702

Pistolet ogrodowy metalowy regulowany SKY-LINE G72900 48



GB Sprinkling gun
DE Spritzpistole
RU Оросительный пистолет
CZ Postřikovací pistole
SK Postrekovacie pistole
HU Öntöző pisztoly
RO Pistol pt. pulverizare



Kod EAN
5901477194672

Pistolet ogrodowy regulowany BRASS-LINE T07300 36



GB Sprinkling gun
DE Spritzpistole
RU Оросительный пистолет
CZ Postřikovací pistole
SK Postrekovacie pištole
HU Öntöző pisztoly
RO Pistol pt. pulverizare

Kod EAN
5901477194726

Kod produktu 48
Pistolet ogrodowy regulowany SKY-LINE G72902 48



GB Sprinkling gun
DE Spritzpistole
RU Оросительный пистолет
CZ Postřikovací pistole
SK Postrekovacie pištole
HU Öntöző pisztoly
RO Pistol pt. pulverizare

Kod EAN
5901477194733

Kod produktu 12/24
Pistolet ogrodowy regulowany SKY-LINE-kartonik wystawowy G72902A 12/24



GB Garden sprayer
DE Garten sprinkler
RU Распылитель
CZ Sprcha zahradní
SK Sprcha záhradné
HU Kerti locsoló
RO Stropitor

Kod EAN
5901477194740

Kod produktu 48
Pistolet ogrodowy 8-funkcji SKY-LINE G72903 48



GB Garden sprayer
DE Garten sprinkler
RU Распылитель
CZ Sprcha zahradní
SK Sprcha záhradné
HU Kerti locsoló
RO Stropitor

Kod EAN
5901477194757



Kod produktu 12/24
Pistolet ogrodowy 8-funkcji SKY-LINE-kartonik wystawowy G72903A 12/24



GB Sprinkling gun
DE Spritzpistole
RU Оросительный пистолет
CZ Postřikovací pistole
SK Postrekovacie pištole
HU Öntöző pisztoly
RO Pistol pt. pulverizare

Kod EAN
5901477194719

Kod produktu 48
Pistolet ogrodowy metalowy 7-funkcji SKY-LINE G72901 48

GB Sprinkling gun
DE Spritzpistole
RU Оросительный пистолет
CZ Postřikovací pistole
SK Postrekovacie pištole
HU Öntöző pisztoly
RO Pistol pt. pulverizare

Kod EAN
5901477195266

Kod produktu 10
Pistolet ogrodowy 8-funkcji BRASS-LINE T07301 10



GB Fittings for garden hose
DE Armaturen für Gartenschlauch
RU Арматура для поливочных шлангов
CZ Adaptér na kohoutek
SK Adaptér na kohútik
HU Locsolótömlő csatlakozó
RO Conectori furtun gradina

Kod EAN
5901477195273

Kod produktu 10/80
Dysza prosta zraszająca regulowana BRASS-LINE T07304 10/80



GB Fittings for garden hose
DE Armaturen für Gartenschlauch
RU Арматура для поливочных шлангов
CZ Adaptér na kohoutek
SK Adaptér na kohútik
HU Locsolótömlő csatlakozó
RO Conectori furtun gradina

Kod EAN
5901477194764

Kod produktu 240
Dysza prosta zraszająca regulowana SKY-LINE G72907 240



GB Fittings for garden hose
DE Armaturen für Gartenschlauch
RU Арматура для поливочных шлангов
CZ Adaptér na kohoutek
SK Adaptér na kohútik
HU Locsolótömlő csatlakozó
RO Conectori furtun gradina

Kod EAN
5901477194771

Kod produktu 20/240
Dysza prosta zraszająca regulowana SKY-LINE – kartonik wystawowy G72907A 20/240

1/2"



GB Hose nozzle, tap adaptor
DE Bewässerungs Spritz und Anschlussset
RU Набор поливочный
CZ Sprcha zahradní
SK Sprcha záhradné
HU Kerti locsoló
RO Stropitor

Kod EAN
5901477194825

Kod produktu 48
Kpl. akcesoriów ogrodowych 4el. 1/2" SKY-LINE G72925 48

3/4"



GB Hose nozzle, tap adaptor
DE Bewässerungs Spritz und Anschlussset
RU Набор поливочный
CZ Sprcha zahradní
SK Sprcha záhradné
HU Kerti locsoló
RO Stropitor

Kod EAN
5901477194832

Kod produktu 48
Kpl. akcesoriów ogrodowych 4el. 3/4" SKY-LINE G72926 48

1/2"



GB Fittings for garden hose
DE Armaturen für Gartenschlauch
RU Арматура для поливочных шлангов
CZ Adaptér na kohoutek
SK Adaptér na kohútik
HU Locsolótömlő csatlakozó
RO Conectori furtun gradina

Kod EAN
5901477194849

Kod produktu 240
Szybkozłącze 1/2" SKY-LINE G72931 240

1/2"



GB Fittings for garden hose
DE Armaturen für Gartenschlauch
RU Арматура для поливочных шлангов
CZ Adaptér na kohoutek
SK Adaptér na kohútik
HU Locsolótömlő csatlakozó
RO Conectori furtun gradina

Kod EAN
5901477194856

Kod produktu
Szybkozłącze 1/2" SKY-LINE – kartonik wystawowy G72931A 20/240

1/2" STOP



GB Fittings for garden hose
DE Armaturen für Gartenschlauch
RU Арматура для поливочных шлангов
CZ Adaptér na kohoutek
SK Adaptér na kohútik
HU Locsolótömlő csatlakozó
RO Conectori furtun gradina

Kod EAN
5901477194863

Kod produktu
Szybkozłącze 1/2" ze stopem SKY-LINE G72932 240

1/2" STOP



GB Fittings for garden hose
DE Armaturen für Gartenschlauch
RU Арматура для поливочных шлангов
CZ Adaptér na kohoutek
SK Adaptér na kohútik
HU Locsolótömlő csatlakozó
RO Conectori furtun gradina

Kod EAN
5901477194870

Kod produktu
Szybkozłącze 1/2" ze stopem SKY-LINE - kartonik wystawowy G72932A 20/240

3/4"



GB Fittings for garden hose
DE Armaturen für Gartenschlauch
RU Арматура для поливочных шлангов
CZ Adaptér na kohoutek
SK Adaptér na kohútik
HU Locsolótömlő csatlakozó
RO Conectori furtun gradina

Kod EAN
5901477194887

Kod produktu
Szybkozłącze 3/4" SKY-LINE G72933 240

3/4"



GB Fittings for garden hose
DE Armaturen für Gartenschlauch
RU Арматура для поливочных шлангов
CZ Adaptér na kohoutek
SK Adaptér na kohútik
HU Locsolótömlő csatlakozó
RO Conectori furtun gradina

Kod EAN
5901477194894

Kod produktu
Szybkozłącze 3/4" SKY-LINE – kartonik wystawowy G72933A 20/240

3/4" STOP



GB Fittings for garden hose
DE Armaturen für Gartenschlauch
RU Арматура для поливочных шлангов
CZ Adaptér na kohoutek
SK Adaptér na kohútik
HU Locsolótömlő csatlakozó
RO Conectori furtun gradina

Kod EAN
5901477194900

Kod produktu
Szybkozłącze 3/4" ze stopem SKY-LINE G72934 240

3/4" STOP



GB Fittings for garden hose
DE Armaturen für Gartenschlauch
RU Арматура для поливочных шлангов
CZ Adaptér na kohoutek
SK Adaptér na kohútik
HU Locsolótömlő csatlakozó
RO Conectori furtun gradina

Kod EAN
5901477194917

Kod produktu
Szybkozłącze 3/4" ze stopem SKY-LINE – kartonik wystawowy G72934A 20/240

3/4"



GB Fittings for garden hose
DE Armaturen für Gartenschlauch
RU Арматура для поливочных шлангов
CZ Adaptér na kohoutek
SK Adaptér na kohútik
HU Locsolótömlő csatlakozó
RO Conectori furtun gradina

Kod EAN
5901477194948

Kod produktu
Reperator 3/4" SKY-LINE G72940 240

3/4"



GB Fittings for garden hose
DE Armaturen für Gartenschlauch
RU Арматура для поливочных шлангов
CZ Adaptér na kohoutek
SK Adaptér na kohútik
HU Locsolótömlő csatlakozó
RO Conectori furtun gradina

Kod EAN
5901477194955

Kod produktu
Reperator 3/4" SKY-LINE – kartonik wystawowy G72940A 20/240

1/2" 3/4"



GB Fittings for garden hose
DE Armaturen für Gartenschlauch
RU Арматура для поливочных шлангов
CZ Adaptér na kohoutek
SK Adaptér na kohútik
HU Locsolótömlő csatlakozó
RO Conectori furtun gradina

Kod EAN
5901477194924

Kod produktu
Reperator redukcyjny 1/2" na 3/4" SKY-LINE G72941 240

1/2" 3/4"



GB Fittings for garden hose
DE Armaturen für Gartenschlauch
RU Арматура для поливочных шлангов
CZ Adaptér na kohoutek
SK Adaptér na kohútik
HU Locsolótömlő csatlakozó
RO Conectori furtun gradina

Kod EAN
5901477194931

Kod produktu
Reperator redukcyjny 1/2" na 3/4" SKY-LINE – kartonik wystawowy G72941A 20/240

1/2"



GB Fittings for garden hose
DE Armaturen für Gartenschlauch
RU Арматура для поливочных шлангов
CZ Adaptér na kohoutek
SK Adaptér na kohútik
HU Locsolótömlő csatlakozó
RO Conectori furtun gradina

Kod EAN
5901477194962

Kod produktu
Reperator 1/2" SKY-LINE G72939 240

1/2"



GB Fittings for garden hose
DE Armaturen für Gartenschlauch
RU Арматура для поливочных шлангов
CZ Adaptér na kohoutek
SK Adaptér na kohútik
HU Locsolótömlő csatlakozó
RO Conectori furtun gradina

Kod EAN
5901477194979

Kod produktu
Reperator 1/2" SKY-LINE – kartonik wystawowy G72939A 20/240

1"



GB Fittings for garden hose
DE Armaturen für Gartenschlauch
RU Арматура для поливочных шлангов
CZ Adaptér na kohoutek
SK Adaptér na kohútik
HU Locsolótömlő csatlakozó
RO Conectori furtun gradina

Kod EAN
5901477195129

Kod produktu
Przyłącze na kran 1" z redukcjami 3/4" i 1/2" SKY-LINE G72945 240

1"



GB Fittings for garden hose
DE Armaturen für Gartenschlauch
RU Арматура для поливочных шлангов
CZ Adaptér na kohoutek
SK Adaptér na kohútik
HU Locsolótömlő csatlakozó
RO Conectori furtun gradina

Kod EAN
5901477195136

Kod produktu
Przyłącze na kran 1" z redu, 3/4" i 1/2" SKY-LINE-kartonik wystawowy G72945A 30/240

3/4"



GB Fittings for garden hose
DE Armaturen für Gartenschlauch
RU Арматура для поливочных шлангов
CZ Adaptér na kohoutek
SK Adaptér na kohútik
HU Locsolótömlő csatlakozó
RO Conectori furtun gradina

Kod EAN
5901477195143

Kod produktu
Przyłącze na kran 3/4" z redukcją 1/2" SKY-LINE G72946 240

3/4"



GB Fittings for garden hose
DE Armaturen für Gartenschlauch
RU Арматура для поливочных шлангов
CZ Adaptér na kohoutek
SK Adaptér na kohútik
HU Locsolótömlő csatlakozó
RO Conectori furtun gradina

Kod EAN
5901477195150

Kod produktu
Przyłącze na kran 3/4" z redukcją 1/2" SKY-LINE-kartonik wystawowy G72946A 30/240



GB Fittings for garden hose
DE Armaturen für Gartenschlauch
RU Арматура для поливочных шлангов
CZ Adaptér na kohoutek
SK Adaptér na kohútik
HU Locsolótömlő csatlakozó
RO Conectori furtun gradina

Kod EAN
5901477195167

Kod produktu
Trójnik do szybkozłączy SKY-LINE G72950 240



GB Fittings for garden hose
DE Armaturen für Gartenschlauch
RU Арматура для поливочных шлангов
CZ Adaptér na kohoutek
SK Adaptér na kohútik
HU Locsolótömlő csatlakozó
RO Conectori furtun gradina

Kod EAN
5901477195174

Kod produktu
Trójnik do szybkozłączy SKY-LINE-kartonik wystawowy G72950A 30/240



GB Fittings for garden hose
DE Armaturen für Gartenschlauch
RU Арматура для поливочных шлангов
CZ Adaptér na kohoutek
SK Adaptér na kohútik
HU Locsolótömlő csatlakozó
RO Conectori furtun gradina

Kod EAN
5901477194986

Kod produktu
Rozdzielacz 2-drożny 3/4" z redukcją 1/2" i dwoma zaworami - wyjściami 1/2" SKY-LINE G72949 120



GB Fittings for garden hose
DE Armaturen für Gartenschlauch
RU Арматура для поливочных шлангов
CZ Adaptér na kohoutek
SK Adaptér na kohútik
HU Locsolótömlő csatlakozó
RO Conectori furtun gradina

Kod EAN
5901477194993

Kod produktu
Rozdzielacz 2-drożny 3/4" z redukcją 1/2" i dwoma zaworami - wyjściami 1/2" SKY-LINE – kartonik wystawowy G72949A 20/120



GB Fittings for garden hose
DE Armaturen für Gartenschlauch
RU Арматура для поливочных шлангов
CZ Adaptér na kohoutek
SK Adaptér na kohútik
HU Locsolótömlő csatlakozó
RO Conectori furtun gradina

Kod EAN
5901477195181

Kod produktu
Nypel do szybkozłączy SKY-LINE G72951 240



GB Fittings for garden hose
DE Armaturen für Gartenschlauch
RU Арматура для поливочных шлангов
CZ Adaptér na kohoutek
SK Adaptér na kohútik
HU Locsolótömlő csatlakozó
RO Conectori furtun gradina

Kod EAN
5901477195198

Kod produktu
Nypel do szybkozłączy SKY-LINE – kartonik wystawowy G72951A 30/240



GB Universal tap connector
DE Universaler Wasserhahnanschluss
RU Универсальный переходник на кран
CZ Univerzální přípojka na kohoutek
SK Univerzálna prípojka na kohútik
HU Univerzális csatlakozó csaphoz
RO Adaptor universal pentru robinet

Kod EAN
5903418300531

Kod produktu
Przyłącze uniwersalne na kran z opaską zaciskową SKY-LINE G72947 100



GB Quick connector with valve
DE Schnellkupplung mit Ventil
RU Быстроразъёмное соединение с клапаном
CZ Rychlospojka s ventilem
SK Rýchlospojka s ventilom
HU Gyorscsatlakozó szeleppel
RO Cuplă rapidă cu supapă



5903418300517

Szybkozłącze z zaworem zakończone nyplem SKY-LINE G72935 100



GB Nipple with valve
DE Nippel mit Ventil
RU Ниппель с клапаном
CZ Nipl s ventilem
SK Nipel s ventilom
HU Szelepes közcsonvar
RO Niplu cu supapă



5903418300524

Nypel z zaworem do szybkozłączy SKY-LINE G72952 100



GB Distributor with valves
DE Verteiler mit Ventilen
RU Распределитель с клапанами
CZ Rozdělovač s ventily
SK Rozdeľovač s ventilmi
HU Elosztó szelepekkel
RO Distribuitor cu supape



5903418300487

Rozdzielacz z zaworami 4-drożny 3/4" z redukcją 1/2" SKY-LINE G72959 12



GB Water flow controller
DE Wasserdurchflussregler
RU Регулятор потока воды
CZ Regulátor průtoku vody
SK Regulátor prietoku vody
HU Vízáramlás-szabályozó
RO Controler debit apă



5903418300494

Mechaniczny sterownik przepływu wody 0-120min SKY-LINE G72962 24

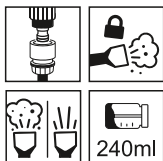

GB Foam sprayer for garden hose
DE Schaumprüher für Gartenschlauch
RU Пеногенератор для садового шланга
CZ Pěnováč na zahradní hadici
SK Penovač na záhradní hadicu
HU Habosító kerti tömlőhöz
RO Spumator pentru furtun de grădină



5903418300548

Pianownica niskociśnieniowa do węża ogrodowego SKY-LINE G72970 6

do 24 m



GB Garden sprayer
DE Garten sprinkler
RU Распылитель
CZ Sprcha zahradní
SK Sprcha záhradné
HU Kerti locsoló
RO Stropitor



5901477118227

Zraszacz pulsacyjny plastik BLUE LINE G73050 50

do 24 m



GB Garden sprayer
DE Garten sprinkler
RU Распылитель
CZ Sprcha zahradní
SK Sprcha záhradné
HU Kerti locsoló
RO Stropitor



5901477124518

Zraszacz pulsacyjny metalowy G73051 40



GB Garden sprayer
DE Garten sprinkler
RU Распылитель
CZ Sprcha zahradní
SK Sprcha záhradné
HU Kerti locsoló
RO Stropitor



5901477194801

Zraszacz FLOWER 8-funkcji SKY-LINE G72919 48

do 24 m



GB Garden sprayer
DE Garten sprinkler
RU Распылитель
CZ Sprcha zahradní
SK Sprcha záhradné
HU Kerti locsoló
RO Stropitor



5901477194795

Zraszacz pulsacyjny obrotowy regulowany SKY-LINE G72915 48



GB Garden sprayer
DE Garten sprinkler
RU Распылитель
CZ Sprcha zahradní
SK Sprcha záhradné
HU Kerti locsoló
RO Stropitor



5901477194818

Zraszacz obrotowy trzyramienny SKY-LINE G72920 48



GB Garden sprayer
DE Garten sprinkler
RU Распылитель
CZ Sprcha zahradní
SK Sprcha záhradné
HU Kerti locsoló
RO Stropitor



5901477195259

Zraszacz oscylacyjny regulowany 20 otworów SKY-LINE G72911 12



do
24
m



GB Garden sprayer
DE Garten sprinkler
RU Распылитель
CZ Sprcha zahradní
SK Sprcha záhradné
HU Kerti locsoló
RO Stropitor



5901477194788

Zraszacz oscylacyjny regulowany 15 otworów SKY-LINE G72910 12



GB Garden sprayer
DE Garten sprinkler
RU Распылитель
CZ Sprcha zahradní
SK Sprcha záhradné
HU Kerti locsoló
RO Stropitor



5901477123993

Zraszacz metalowy pulsacyjny na stojaku G73056 10

1/2" 60m



1/2" 25m



GB Hose holder
DE Gartenschlauchträger
RU Барабан для намотки поливочного шланга
CZ Stojan navjceľ na zahradní hadici
SK Stojan navjceľ na zahradní hadicu
HU Utartódob locsolótömlöhöz
RO Suport pt. furtun



5903418300500

Wózek metalowy na wąż ogrodowy 1/2"-60m SKY-LINE G72967 5

GB Hose holder
DE Gartenschlauchträger
RU Держатель шланга
CZ Stojan navjceľ na zahradní hadici
SK Stojan navjceľ na zahradní hadicu
HU Utartódob locsolótömlöhöz
RO Suport pt. furtun



5901477118296

Stojak do 25m węża ogrodowego/niebieski/ G73222 8

1/2" 60m



GB Hose holder
DE Gartenschlauchträger
RU Барабан для намотки поливочного шланга
CZ Stojan navjceľ na zahradní hadici
SK Stojan navjceľ na zahradní hadicu
HU Utartódob locsolótömlöhöz
RO Suport pt. furtun



5901477118302

Wózek do 60m węża ogrodowego/niebieski/ G73224 4

1/2" 60m



1/2" 60m



GB Hose holder
DE Gartenschlauchträger
RU Барабан для намотки поливочного шланга
CZ Stojan navjceľ na zahradní hadici
SK Stojan navjceľ na zahradní hadicu
HU Utartódob locsolótömlöhöz
RO Suport pt. furtun



5901477159664

Wózek na wąż 60m ALU-POLSKA G73227 5

GB Hose holder
DE Gartenschlauchträger
RU Барабан для намотки поливочного шланга
CZ Stojan navjceľ na zahradní hadici
SK Stojan navjceľ na zahradní hadicu
HU Utartódob locsolótömlöhöz
RO Suport pt. furtun



5901477195228

Wózek z prowadnicą na wąż ogrodowy 1/2"=60m SKY-LINE G72965 4

1/2" 45m



GB Hose holder
DE Gartenschlauchträger
RU Барабан для намотки поливочного шланга
CZ Stojan navijecí na zahradní hadici
SK Stojan navijecí na zahradní hadicu
HU Utartódob locsolótömlőhöz
RO Suport pt. furtun



5901477195235

Wózek na wąż ogrodowy 1/2"=45m SKY-LINE G72966 5

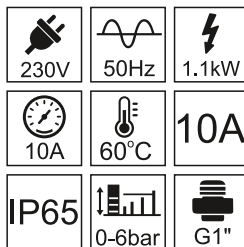

GB Automatic pump controller
DE Automatische Pumpensteuerung
RU Автоматический контроллер насоса
CZ Automatický ovladač čerpadla
SK Automatický ovladač čerpadla
HU Automatikus szivattyúvezérlő
RO Controler automat pentru pompă



5901477199561

Automatyczny sterownik pompy PC-59N G81510 12



GB Ground hose guide
DE Bodenschlauchführung
RU Направляющая наземного шланга
CZ Vedení zemní hadice
SK Vedenie zemnej hadice
HU Földelő tömlővezető
RO Ghidajul furtunului de împământare



5901477195242

Prowadnica do węża ogrodowego wbijana SKY-LINE G72955 48

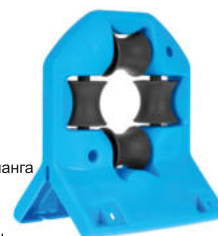

GB Ground hose guide
DE Bodenschlauchführung
RU Направляющая наземного шланга
CZ Vedení zemní hadice
SK Vedenie zemnej hadice
HU Földelő tömlővezető
RO Ghidajul furtunului de împământare



5901477195211

Prowadnica do węża ogrodowego narożna SKY-LINE G72956 24



GB Hose hanger
DE Gartenschlauchträger
RU Кронштейн настенный для шланга
CZ Věšák na hadici zahradní
SK Vešák na hadicu záhradné
HU Kerttömlő-akasztó
RO Suport de perete pt. furtun



5901477140143

Zwijacz-wieszak węża ogrodowego G73225 50



GB Brush for wheel and rim wash
DE Bürste für rad- und felgenreinigung
RU Щетка для чистки колес и дисков
CZ Kartáč pro čištění kol a ráfků
SK Keňa pre čistenie kolies a ráfikov
HU Kefe a kerekekhez és a keréktárcsához
RO Perie pentru curatat jante



5901477151187

Szczotka do mycia kół i opon G73800 12



GB Car wash brush
DE Autowaschbürste
RU Щетка для мытья автомобиля
CZ Průtokový mycí kartáč na mytí vozu
SK Prítokový umývacia kefa na umývanie vozidla
HU Autómosó kefe
RO Perie pentru jante si elemente de caroserie



5901477151194

Szczotka do mycia auta, kół i opon z podłączeniem do węża G73801 50



GB Car wash brush
DE Autowaschbürste
RU Щетка для мытья автомобиля
CZ Průtokový mycí kartáč na mytí vozu
SK Prítokový umývacia kefa na umývanie vozidla
HU Autómosó kefe
RO Perie pentru jante si elemente de caroserie



5901477177378

Szczotka do mycia samochodu 4 płaszczyznowa 31x14x12cm G73804 10

0.7-1.3 m



GB Car wash brush
DE Autowaschbürste
RU Щетка для мытья автомобиля
CZ Průtokový mycí kartáč na mytí vozu
SK Prítokový umývacia kefa na umývanie vozidla
HU Autómosó kefe
RO Perie pentru jante si elemente de caroserie



5901477151200

Teleskopowa szczotka do mycia auta 0.7-1.3 m G73802 12

1.3-2.2 m





GB Car wash brush
DE Autowaschbürste
RU Щетка для мытья автомобиля
CZ Průtokový mycí kartáč na mytí vozu
SK Prítokový umývacia kefa na umývanie vozidla
HU Autómosó kefe
RO Perie pentru jante si elemente de caroserie



5901477151217

Teleskopowa szczotka do mycia auta czteropłaszczyznowa 1.3-2.2 G73803 8

22x12x7 cm

GB Car Wash Sponge
DE Autowaschschwamm
RU Губка для автомойки
CZ Houbiček automobilů
SK Hubiek automobilov
HU Autószivacs
RO Burete pentru spalare auto

Kod EAN
5901477151224

Kod produktu
G73810 50

Gąbka do mycia auta

24x11x5.5 cm





GB Microfiber Car Wash Sponge
DE Microfaser-Autowaschschwamm
RU Губка для мытья автомобилей из микрофибры
CZ Houbiček automobilů z mikrovláken
SK Hubiek automobilov mikrovláken
HU Szivacs autómósó mikroszálás
RO Burete pentru spalare auto cu microfibra

Kod EAN
5901477151231

Kod produktu
G73811 50

Gąbka z mikrofibry do mycia auta

24x12x6 cm

GB Car wash sponge
DE Autowaschschwamm
RU Губка для автомойки
CZ Houbiček automobilů
SK Hubiek automobilov
HU Autószivacs
RO Burete pentru spalare auto

Kod EAN
5901477151248

Kod produktu
G73812 50

Szenilowa gąbka do mycia auta



GB Rim brush
DE Felgenbürste
RU Ободная щетка
CZ Kartáč na ráfky
SK Kefa na ráfiky
HU Peremkefe
RO Perie pentru margini

Kod EAN
5901477168901

Kod produktu
G73820 25

Szczotka do mycia felg z długą rączką



GB Rim brush
DE Felgenbürste
RU Ободная щетка
CZ Kartáč na ráfky
SK Kefa na ráfiky
HU Peremkefe
RO Perie pentru margini

Kod EAN
5901477168895

Kod produktu
G73821 50

Szczotka do mycia felg i kołpaków

5 pcs



GB Wash brush set
DE Waschbürstenset
RU Набор стиральных щеток
CZ Sada kartáčů mytí
SK Súprava kefy na umývanie
HU Mosókefe készlet
RO Set perie de spălare

Kod EAN
5901477168918

Kod produktu
G73825 50

Zestaw pędzli 5szt. do mycia detailingowego 20-40mm

2-4.9 m



GB Telescopic brush for cleaning photovoltaic panels
DE Teleskopbürste zum Reinigen von Photovoltaikmodulen
RU Телескопическая щетка для очистки фотоэлектрических
CZ Teleskopický kartáč na čištění fotovoltaických panelů
SK Teleskopická kefa na čistenie fotovoltaických panelov
HU Teleszkópos kefe fotovoltaikus panelek tisztításához
RO Perie telescopica pentru curatarea panourilor fotovoltaice

Kod EAN
5901477180545

Kod produktu
G73880 6

Szczotka teleskopowa do mycia paneli fotowoltaicznych 2-4.9m

1.3-3 m



GB Telescopic brush for cleaning photovoltaic panels
DE Teleskopbürste zum Reinigen von Photovoltaikmodulen
RU Телескопическая щетка для очистки фотоэлектрических
CZ Teleskopický kartáč na čištění fotovoltaických panelů
SK Teleskopická kefa na čistenie fotovoltaických panelov
HU Teleszkópos kefe fotovoltaikus panelek tisztításához
RO Perie telescopica pentru curatarea panourilor fotovoltaice

Kod EAN
5901477180552

Kod produktu
G73881 12

Szczotka teleskopowa do mycia paneli fotowoltaicznych 1.3-3m

1/2"



GB Fittings for garden hose
DE Armaturen für Gartenschlauch
RU Арматура для поливочных шлангов
CZ Adaptér na kohoutek
SK Adaptér na kohútik
HU Locsolótömlő csatlakozó
RO Conectori furtun gradina

Kod EAN
5901477195280

Kod produktu
T07313 10/80

Reperator 1/2" BRASS-LINE

3/4"



GB Fittings for garden hose
DE Armaturen für Gartenschlauch
RU Арматура для поливочных шлангов
CZ Adaptér na kohoutek
SK Adaptér na kohútik
HU Locsolótömlő csatlakozó
RO Conectori furtun gradina

Kod EAN
5901477195297

Kod produktu
T07314 10/80

Reperator 3/4" BRASS-LINE

1/2" STOP



GB Fittings for garden hose
DE Armaturen für Gartenschlauch
RU Арматура для поливочных шлангов
CZ Adaptér na kohoutek
SK Adaptér na kohútik
HU Locsolótömlő csatlakozó
RO Conectori furtun gradina



Szybkozłącze 1/2" ze stopem BRASS-LINE T07306 10/80

3/4" STOP



GB Fittings for garden hose
DE Armaturen für Gartenschlauch
RU Арматура для поливочных шлангов
CZ Adaptér na kohoutek
SK Adaptér na kohútik
HU Locsolótömlő csatlakozó
RO Conectori furtun gradina



Szybkozłącze 3/4" ze stopem BRASS-LINE T07308 10/80

1/2"



GB Fittings for garden hose
DE Armaturen für Gartenschlauch
RU Арматура для поливочных шлангов
CZ Adaptér na kohoutek
SK Adaptér na kohútik
HU Locsolótömlő csatlakozó
RO Conectori furtun gradina



Szybkozłącze 1/2" BRASS-LINE T07305 10/80

3/4"



GB Fittings for garden hose
DE Armaturen für Gartenschlauch
RU Арматура для поливочных шлангов
CZ Adaptér na kohoutek
SK Adaptér na kohútik
HU Locsolótömlő csatlakozó
RO Conectori furtun gradina



Szybkozłącze 3/4" BRASS-LINE T07307 10/80

3/4"



GB Fittings for garden hose
DE Armaturen für Gartenschlauch
RU Арматура для поливочных шлангов
CZ Adaptér na kohoutek
SK Adaptér na kohútik
HU Locsolótömlő csatlakozó
RO Conectori furtun gradina



Przyłącze z gwintem zewnętrznym 3/4" BRASS-LINE T07320 10/80

1/2"



GB Fittings for garden hose
DE Armaturen für Gartenschlauch
RU Арматура для поливочных шлангов
CZ Adaptér na kohoutek
SK Adaptér na kohútik
HU Locsolótömlő csatlakozó
RO Conectori furtun gradina



Przyłącze na kran 1/2" BRASS-LINE T07321 10/80

3/4"



GB Fittings for garden hose
DE Armaturen für Gartenschlauch
RU Арматура для поливочных шлангов
CZ Adaptér na kohoutek
SK Adaptér na kohútik
HU Locsolótömlő csatlakozó
RO Conectori furtun gradina



Przyłącze na kran 3/4" BRASS-LINE T07322 10/80

1"



GB Fittings for garden hose
DE Armaturen für Gartenschlauch
RU Арматура для поливочных шлангов
CZ Adaptér na kohoutek
SK Adaptér na kohútik
HU Locsolótömlő csatlakozó
RO Conectori furtun gradina



Przyłącze na kran 1" BRASS-LINE T07323 10/80

3/4" na 1/2"



GB Fittings for garden hose
DE Armaturen für Gartenschlauch
RU Арматура для поливочных шлангов
CZ Adaptér na kohoutek
SK Adaptér na kohútik
HU Locsolótömlő csatlakozó
RO Conectori furtun gradina



Przyłącze na kran 3/4" z redukcją 1/2" BRASS-LINE T07324 10/80

1" na 3/4"



GB Fittings for garden hose
DE Armaturen für Gartenschlauch
RU Арматура для поливочных шлангов
CZ Adaptér na kohoutek
SK Adaptér na kohútik
HU Locsolótömlő csatlakozó
RO Conectori furtun gradina



Przyłącze na kran 1" z redukcją 3/4" BRASS-LINE T07325 10/80

1/2"



GB Fittings for garden hose
DE Armaturen für Gartenschlauch
RU Арматура для поливочных шлангов
CZ Adaptér na kohoutek
SK Adaptér na kohútik
HU Locsolótömlő csatlakozó
RO Conectori furtun gradina



Nypel do szybkozłączy BRASS-LINE T07329 10/80

3/4"



GB Fittings for garden hose
DE Armaturen für Gartenschlauch
RU Арматура для поливочных шлангов
CZ Adaptér na kohoutek
SK Adaptér na kohútik
HU Locsolótömlő csatlakozó
RO Conectori furtun gradina



Trójnik do łączenia 3 szybkozłączy BRASS-LINE T07330 10/80

1/2"



GB Connector Coupling
DE Klauenkupplung
RU Соединения Гека
CZ Spojka svěrací
SK Pazúrová spojka
HU Sárgaréz karmos
RO Gheară de alamă

Kod EAN
5901477195426

Kod produktu

Złącze kłowe mosiężne kompatybilne z GEKA na wąż 1/2" G70152 10/80

3/4"



GB Connector Coupling
DE Klauenkupplung
RU Соединения Гека
CZ Spojka svěrací
SK Pazúrová spojka
HU Sárgaréz karmos
RO Gheară de alamă

Kod EAN
5901477195433

Kod produktu

Złącze kłowe mosiężne kompatybilne z GEKA na wąż 3/4" G70153 10/80



GB Connector Coupling
DE Klauenkupplung
RU Соединения Гека
CZ Spojka svěrací
SK Pazúrová spojka
HU Sárgaréz karmos
RO Gheară de alamă

Kod EAN
5901477195440

Kod produktu

Złącze kłowe mosiężne kompatybilne z GEKA z przyłączem G70151 10/80



GB Brass connector
DE Stecker aus Messing
RU Латунный соединитель
CZ Mosazný konektor
SK Mosadzný konektor
HU Sárgaréz csatlakozó
RO Conector din alamă

Kod EAN
5901477173677

Kod produktu

Złącze kłowe mosiężne kompatybilne z GEKA – zamykające G70150 12/96

GZ 1"



GB Brass connector
DE Stecker aus Messing
RU Латунный соединитель
CZ Mosazný konektor
SK Mosadzný konektor
HU Sárgaréz csatlakozó
RO Conector din alamă

Kod EAN
5901477173516

Kod produktu

Złącze kłowe mosiężne kompatybilne z GEKA - GZ 1" G70110 12/96

GZ 1/2"



GB Brass connector
DE Stecker aus Messing
RU Латунный соединитель
CZ Mosazný konektor
SK Mosadzný konektor
HU Sárgaréz csatlakozó
RO Conector din alamă

Kod EAN
5901477173523

Kod produktu

Złącze kłowe mosiężne kompatybilne z GEKA - GZ 1/2" G70111 12/96

GZ 3/4"



GB Brass connector
DE Stecker aus Messing
RU Латунный соединитель
CZ Mosazný konektor
SK Mosadzný konektor
HU Sárgaréz csatlakozó
RO Conector din alamă

Kod EAN
5901477173530

Kod produktu

Złącze kłowe mosiężne kompatybilne z GEKA - GZ 3/4" G70112 12/96

GW 1/4"



GB Brass connector
DE Stecker aus Messing
RU Латунный соединитель
CZ Mosazný konektor
SK Mosadzný konektor
HU Sárgaréz csatlakozó
RO Conector din alamă

Kod EAN
5901477173547

Kod produktu

Złącze kłowe mosiężne kompatybilne z GEKA-GW 1/4" G70120 12/96

GW 3/4"



GB Brass connector
DE Stecker aus Messing
RU Латунный соединитель
CZ Mosazný konektor
SK Mosadzný konektor
HU Sárgaréz csatlakozó
RO Conector din alamă

Kod EAN
5901477173554

Kod produktu

Złącze kłowe mosiężne kompatybilne z GEKA – GW 3/4" G70121 12/96

GW 3/8"



GB Brass connector
DE Stecker aus Messing
RU Латунный соединитель
CZ Mosazný konektor
SK Mosadzný konektor
HU Sárgaréz csatlakozó
RO Conector din alamă

Kod EAN
5901477173561

Kod produktu

Złącze kłowe mosiężne kompatybilne z GEKA – GW 3/8" G70122 12/96

GW 1 1/2"



GB Brass connector
DE Stecker aus Messing
RU Латунный соединитель
CZ Mosazný konektor
SK Mosadzný konektor
HU Sárgaréz csatlakozó
RO Conector din alamă

Kod EAN
5901477173578

Kod produktu

Złącze kłowe mosiężne kompatybilne z GEKA-GW 1 1/2" G70123 12/96

GW 1 1/4"



GB Brass connector
DE Stecker aus Messing
RU Латунный соединитель
CZ Mosazný konektor
SK Mosadzný konektor
HU Sárgaréz csatlakozó
RO Conector din alamă

Kod EAN
5901477173585

Kod produktu

Złącze kłowe mosiężne kompatybilne z GEKA-GW 1 1/4" G70124 12/96

GW 1"



GB Brass connector
DE Stecker aus Messing
RU Латунный соединитель
CZ Mosazný konektor
SK Mosadzný konektor
HU Sárgaréz csatlakozó
RO Conector din alamă



5901477173592

Złącze kłowe mosiężne kompatybilne z GEKA-GW 1" G70125 12/96

GW 1/2"



GB Brass connector
DE Stecker aus Messing
RU Латунный соединитель
CZ Mosazný konektor
SK Mosadzný konektor
HU Sárgaréz csatlakozó
RO Conector din alamă



5901477173608

Złącze kłowe mosiężne kompatybilne z GEKA-GW 1/2" G70126 12/96

GW 1"



GB Brass connector
DE Stecker aus Messing
RU Латунный соединитель
CZ Mosazný konektor
SK Mosadzný konektor
HU Sárgaréz csatlakozó
RO Conector din alamă



5901477173615

Złącze kłowe mosiężne kompatybilne z GEKA z króćcem 1" G70130 12/96

GW 1/2"



GB Brass connector
DE Stecker aus Messing
RU Латунный соединитель
CZ Mosazný konektor
SK Mosadzný konektor
HU Sárgaréz csatlakozó
RO Conector din alamă



5901477173622

Złącze kłowe mosiężne kompatybilne z GEKA z króćcem 1/2" G70131 12/16/96

GW 3/4"



GB Brass connector
DE Stecker aus Messing
RU Латунный соединитель
CZ Mosazný konektor
SK Mosadzný konektor
HU Sárgaréz csatlakozó
RO Conector din alamă



5901477173639

Złącze kłowe mosiężne kompatybilne z GEKA z króćcem 3/4" G70132 16/96

GW 3/8"



GB Brass connector
DE Stecker aus Messing
RU Латунный соединитель
CZ Mosazný konektor
SK Mosadzný konektor
HU Sárgaréz csatlakozó
RO Conector din alamă



5901477173646

Złącze kłowe mosiężne kompatybilne z GEKA z króćcem 3/8" G70133 12/96

GW 1/2"
360°



GB Brass connector
DE Stecker aus Messing
RU Латунный соединитель
CZ Mosazný konektor
SK Mosadzný konektor
HU Sárgaréz csatlakozó
RO Conector din alamă



5901477173653

Złącze kłowe mosiężne kompatybilne z GEKA-360° obrotowe 1/2" G70140 12/96

GW 3/4"
360°



GB Brass connector
DE Stecker aus Messing
RU Латунный соединитель
CZ Mosazný konektor
SK Mosadzný konektor
HU Sárgaréz csatlakozó
RO Conector din alamă



5901477173660

Złącze kłowe mosiężne kompatybilne z GEKA-360° obrotowe 3/4" G70141 12/96

GW 3/4"
x 2
GZ 3/4"



GB Fittings for garden hose
DE Armaturen für Gartenschlauch
RU Арматура для поливочных шлангов
CZ Adaptér na kohoutek
SK Adaptér na kohútik
HU Locsolótómító csatlakozó
RO Conectori furtun gradina



5901477173691

Rozdzielacz 2-drożny na kran GW3/4" x 2 GZ3/4" z zaworami kulowymi G70156 10/60

GW 3/4"
x 2
GZ 3/4"



GB Fittings for garden hose
DE Armaturen für Gartenschlauch
RU Арматура для поливочных шлангов
CZ Adaptér na kohoutek
SK Adaptér na kohútik
HU Locsolótómító csatlakozó
RO Conectori furtun gradina



5901477195464

Rozdzielacz 2-drożny na kran GW3/4" x 2 GZ3/4" z zaworami i szybkozłączami G70157 10/60

GB IBC set for mauser
DE IBC-Set für Mauser
RU Набор IBC для маузера
CZ IBC sada pro mauser
SK Súprava IBC pre mauser
HU IBC készlet mauserhez
RO Set IBC pentru mauser



5901477195471

Zestaw-IBC nakrętka S60x6 + kran 1/2" z wyjściem na GZ 3/4" + wtyk na wąż 1/2" + nypel do szybkozłącza – mauser G70180 40

GB IBC set for mauser
DE IBC-Set für Mauser
RU Набор IBC для маузера
CZ IBC sada pro mauser
SK Súprava IBC pre mauser
HU IBC készlet mauserhez
RO Set IBC pentru mauser



5901477195501

Zestaw-IBC nakrętka S60x6 + kran 1/2" z wyjściem na GZ 3/4" + nypel do szybkozłącza – mauser G70183 40





GB IBC set for mauser
DE IBC-Set für Mauser
RU Набор IBC для маузера
CZ IBC sada pro mauser
SK Súprava IBC pre mauser
HU IBC készlet mauserhez
RO Set IBC pentru mauser

Kod EAN
5901477195518

Zestaw-IBC nakrętka S60x6 + kran 3/4" z wyjściem na GZ 1" + nypel do szybkozłącza – mauser

Kod produktu G70184 40





GB IBC set for mauser
DE IBC-Set für Mauser
RU Набор IBC для маузера
CZ IBC sada pro mauser
SK Súprava IBC pre mauser
HU IBC készlet mauserhez
RO Set IBC pentru mauser

Kod EAN
5901477195525

Zestaw – kran 1/2" z wyjściem na GZ 3/4" + nypel do szybkozłącza – mauser

Kod produktu G70185 50





GB IBC set for mauser
DE IBC-Set für Mauser
RU Набор IBC для маузера
CZ IBC sada pro mauser
SK Súprava IBC pre mauser
HU IBC készlet mauserhez
RO Set IBC pentru mauser

Kod EAN
5901477195532

Zestaw – kran 3/4" z wyjściem na GZ 1" + nypel do szybkozłącza – mauser

Kod produktu G70186 50





GB IBC set for mauser
DE IBC-Set für Mauser
RU Набор IBC для маузера
CZ IBC sada pro mauser
SK Súprava IBC pre mauser
HU IBC készlet mauserhez
RO Set IBC pentru mauser

Kod EAN
5901477195549

Zestaw – kran 1/2" z wyjściem na GZ 3/4" + wtyk na wąż 1/2" – mauser

Kod produktu G70187 50





GB IBC set for mauser
DE IBC-Set für Mauser
RU Набор IBC для маузера
CZ IBC sada pro mauser
SK Súprava IBC pre mauser
HU IBC készlet mauserhez
RO Set IBC pentru mauser

Kod EAN
5901477195556

Zestaw – kran 3/4" z wyjściem na GZ 3/4" + wtyk na wąż 3/4" – mauser

Kod produktu G70188 50

GB IBC set for mauser
DE IBC-Set für Mauser
RU Набор IBC для маузера
CZ IBC sada pro mauser
SK Súprava IBC pre mauser
HU IBC készlet mauserhez
RO Set IBC pentru mauser

Kod EAN
5901477195563

Zestaw – kran 3/4" z wyjściem na GZ 1" + wtyk na wąż 3/4" – mauser

Kod produktu G70189 50



GB IBC set for mauser
DE IBC-Set für Mauser
RU Набор IBC для маузера
CZ IBC sada pro mauser
SK Súprava IBC pre mauser
HU IBC készlet mauserhez
RO Set IBC pentru mauser

Kod EAN
5901477195570

Zestaw – kran 1/2" podwójny z wyjściami na GZ 3/4" + wtyk na wąż 1/2" + nypel do szybkozłącza – mauser

Kod produktu G70190 40



GB IBC set for mauser
DE IBC-Set für Mauser
RU Набор IBC для маузера
CZ IBC sada pro mauser
SK Súprava IBC pre mauser
HU IBC készlet mauserhez
RO Set IBC pentru mauser

Kod EAN
5901477195587

Zestaw – IBC nakrętka S60x6 + kran 1/2" podwójny z wyjściami na GZ 3/4" + dwa nypel do szybkozłącza – mauser

Kod produktu G70191 30

GW
GZ



GB IBC butterfly valve - Mauser
DE IBC-Kugelhahn - Mauser
RU Дискový клапан IBC Mauser
CZ IBC motýlový ventil - Mauser
SK IBC motýlový ventil - Mauser
HU IBC pillangószelep - Mauser
RO Supapă fluture IBC - Mauser

Kod EAN
5903418301002

Zawór motylkowy mausera IBC GW/GZ-S60x6

Kod produktu G70198 60

GW
GZ



GB IBC butterfly valve - Mauser
DE IBC-Kugelhahn - Mauser
RU Дискový клапан IBC Mauser
CZ IBC motýlový ventil - Mauser
SK IBC motýlový ventil - Mauser
HU IBC pillangószelep - Mauser
RO Supapă fluture IBC - Mauser

Kod EAN
5903418301019

Zawór motylkowy mausera IBC GW-S75x6/GZ-S60x6

Kod produktu G70199 60

GW
1/2"



GB IBC cap - Mauser
DE IBC-Deckel - Mauser
RU Крышка IBC - Маузер
CZ IBC víčko - Mauser
SK IBC uzáver - Mauser
HU IBC kupak - Mauser
RO Capac IBC - Mauser

Kod EAN
5901477195488

IBC nakrętka S60x6 GW 1/2" – mauser

Kod produktu G70181 100

GW
3/4"





GB IBC cap - Mauser
DE IBC-Deckel - Mauser
RU Крышка IBC - Маузер
CZ IBC víčko - Mauser
SK IBC uzáver - Mauser
HU IBC kupak - Mauser
RO Capac IBC - Mauser

Kod EAN
5901477195495

IBC nakrętka S60x6 GW 3/4" – mauser

Kod produktu G70182 100

GW
1"

GB IBC cap - Mauser
DE IBC-Deckel - Mauser
RU Крышка IBC - Маузер
CZ IBC víčko - Mauser
SK IBC uzáver - Mauser
HU IBC kupak - Mauser
RO Capac IBC - Mauser

Kod EAN
5903418305192

Kod produktu
IBC nakrętka S60x6 GW 1" – mauser **G70194** **100**

S60x6



GB IBC extension with cap
DE IBC-Verlängerung mit Deckel
RU Удлинитель IBC с крышкой
CZ IBC prodloužení s víčkem
SK IBC predĺženie s uzáverom
HU IBC hosszabbító kupakkal
RO Prelungitor IBC cu capac

Kod EAN
5903418301026

Kod produktu
Przedłużka IBC z nakrętką S60x6 **G70202** **85**

S60x6



GB IBC cap and hose tap set
DE IBC-Deckel und Schlauchhahn-Set
RU Комплект IBC: крышка и кран для шланга
CZ Sada IBC víčko a kohout na hadici
SK Sada IBC uzáver a ventil na hadici
HU IBC kupak és tömlőcsap készlet
RO Set capac IBC și robinet pentru furtun

Kod EAN
5903418301040

Kod produktu
Zestaw – IBC nakrętka S60x6 + kran na wąż 25mm 90° – mauser **G70205** **80**

S60x6



GB IBC cap and hose tap set
DE IBC-Deckel und Schlauchhahn-Set
RU Комплект IBC: крышка и кран для шланга
CZ Sada IBC víčko a kohout na hadici
SK Sada IBC uzáver a ventil na hadici
HU IBC kupak és tömlőcsap készlet
RO Set capac IBC și robinet pentru furtun

Kod EAN
5903418301033

Kod produktu
Zestaw – IBC nakrętka S60x6 + kran na wąż 32mm 45° – mauser **G70204** **80**

S60x6



GB IBC cap and hose tap set
DE IBC-Deckel und Schlauchhahn-Set
RU Комплект IBC: крышка и кран для шланга
CZ Sada IBC víčko a kohout na hadici
SK Sada IBC uzáver a ventil na hadici
HU IBC kupak és tömlőcsap készlet
RO Set capac IBC și robinet pentru furtun

Kod EAN
5901477195594

Kod produktu
Zestaw – IBC nakrętka S60x6 + kran 1/2" – mauser **G70192** **125**

S60x6



GB IBC cap and hose tap set
DE IBC-Deckel und Schlauchhahn-Set
RU Комплект IBC: крышка и кран для шланга
CZ Sada IBC víčko a kohout na hadici
SK Sada IBC uzáver a ventil na hadici
HU IBC kupak és tömlőcsap készlet
RO Set capac IBC și robinet pentru furtun

Kod EAN
5901477195600

Kod produktu
Zestaw – IBC nakrętka S60x6 + kran 3/4" – mauser **G70193** **125**

1"



GB Ball valve
DE Kugelhahn
RU Шаровый кран
CZ Kulový ventil
SK Guľový ventil
HU Golyócsap
RO Supapă cu bilă

Kod EAN
5903418305673

Kod produktu
Zawór kulowy 1" DN25 z dławkiem i śrubunkiem – motylek **G70225** **40**

1"





GB Ball valve
DE Kugelhahn
RU Шаровый кран
CZ Kulový ventil
SK Guľový ventil
HU Golyócsap
RO Supapă cu bilă

Kod EAN
5903418305703

Kod produktu
Zawór kulowy 1" WW DN25 z dławkiem – rączka **G70228** **40**

1"

GB Ball valve
DE Kugelhahn
RU Шаровый кран
CZ Kulový ventil
SK Guľový ventil
HU Golyócsap
RO Supapă cu bilă

Kod EAN
5903418305642

Kod produktu
Zawór kulowy 1" WZ DN25 z dławkiem – rączka **G70222** **40**

1/2"



GB Ball valve
DE Kugelhahn
RU Шаровый кран
CZ Kulový ventil
SK Guľový ventil
HU Golyócsap
RO Supapă cu bilă

Kod EAN
5903418305659

Kod produktu
Zawór kulowy 1/2" DN15 z dławkiem i śrubunkiem – motylek **G70223** **50**

1/2"



GB Ball valve
DE Kugelhahn
RU Шаровый кран
CZ Kulový ventil
SK Guľový ventil
HU Golyócsap
RO Supapă cu bilă

Kod EAN
5903418305680

Kod produktu
Zawór kulowy 1/2" WW DN15 z dławkiem – rączka **G70226** **50**

1/2"



GB Ball valve
DE Kugelhahn
RU Шаровый кран
CZ Kulový ventil
SK Guľový ventil
HU Golyócsap
RO Supapă cu bilă

Kod EAN
5903418305628

Kod produktu
Zawór kulowy 1/2" WZ DN15 z dławkiem – rączka **G70220** **50**

3/4"



GB Ball valve
DE Kugelhahn
RU Шаровый кран
CZ Kulový ventil
SK Guľový ventil
HU Golyóscsap
RO Supapă cu bilă



Zawór kulowy 3/4" DN20 z dławikiem i śrubunkiem – motylek G70224 50

3/4"



GB Ball valve
DE Kugelhahn
RU Шаровый кран
CZ Kulový ventil
SK Guľový ventil
HU Golyóscsap
RO Supapă cu bilă



Zawór kulowy 3/4" WW DN20 z dławikiem – rączka G70227 50

3/4"

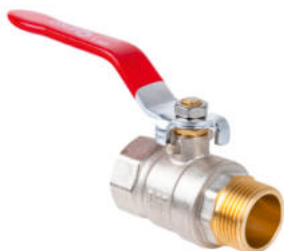

GB Ball valve
DE Kugelhahn
RU Шаровый кран
CZ Kulový ventil
SK Guľový ventil
HU Golyóscsap
RO Supapă cu bilă



Zawór kulowy 3/4" WZ DN20 z dławikiem – rączka G70221 50

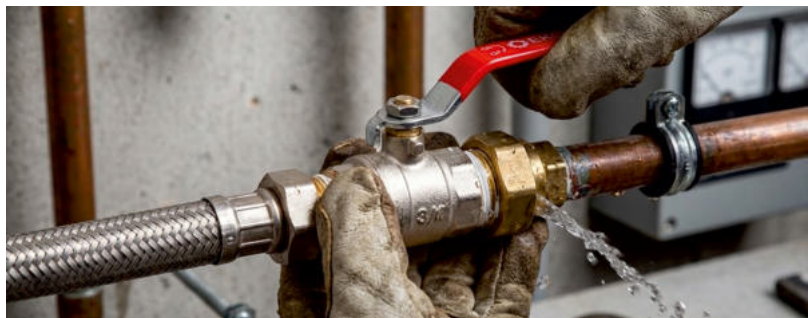

Wężę strażackie / Fire Hoses



1" 20m



GB Firehose
DE Feuerwehr
RU Пожарный рукав
CZ Požární hadice
SK Požiarna hadice
HU Locsolótömlő csatlakozóval
RO Furtun de incendiu



Wąż parciany 1"20m z końcówkami G70001 10

2" 30m



GB Firehose
DE Feuerwehr
RU Пожарный рукав
CZ Požární hadice
SK Požiarna hadice
HU Locsolótömlő csatlakozóval
RO Furtun de incendiu



Wąż parciany/strażak/ 2" 30m ze złączkami G70002 5

2" 20m



GB Firehose
DE Feuerwehr
RU Пожарный рукав
CZ Požární hadice
SK Požiarna hadice
HU Locsolótömlő csatlakozóval
RO Furtun de incendiu



Kod EAN
5901477112751

Wąż parciany/strażacki 2" 20m,3,2kg lekki G70003 5

2" 20m



GB Firehose
DE Feuerwehr
RU Пожарный рукав
CZ Požární hadice
SK Požiarna hadice
HU Locsolótömlő csatlakozóval
RO Furtun de incendiu



Kod EAN
5901477112768

Wąż parciany/strażak/2" 20m 8 bar/ciężki-5kg/ G70004 5

3" 20m



GB Firehose
DE Feuerwehr
RU Пожарный рукав
CZ Požární hadice
SK Požiarna hadice
HU Locsolótömlő csatlakozóval
RO Furtun de incendiu



Kod EAN
5901477126840

Wąż parciany/strażak/3" 20m 8 bar ze złączkami G70005 5

1" 20m



2" 20m

3" 20m

2" 30m



GB Firehose
DE Feuerwehr
RU Пожарный рукав
CZ Požární hadice
SK Požiarna hadice
HU Locsolótömlő csatlakozóval
RO Furtun de incendiu



Kod EAN
5901477128806



Kod EAN
5901477148897



Kod EAN
5901477128790



Kod EAN
5901477169861

Wąż parciany/strażak/ 1" 20m(bez końcówek) G70025 2
Wąż parciany/strażak/ 2" 20m (bez końcówek) G70026 5
Wąż parciany/strażak/ 3" 20m (bez końcówek) G70027 2
Wąż parciany/strażak/ 2" 30m (bez końcówek) G70028 2

2" 20m



2" 30m



GB Firehose
DE Feuerwehr
RU Пожарный рукав
CZ Požární hadice
SK Požiarna hadice
HU Locsolótömlő csatlakozóval
RO Furtun de incendiu



Kod EAN
5901477179983



Kod EAN
5901477179990

Wąż parciany czerwony /strażak/ 2" 20m (bez końcówek) G70033 5
Wąż parciany czerwony /strażak/ 2" 30m (bez końcówek) G70034 5

2" 30m



GB Firehose
DE Feuerwehr
RU Пожарный рукав
CZ Požární hadice
SK Požiarna hadice
HU Locsolótömlő csatlakozóval
RO Furtun de incendiu



Kod EAN
5901477179976

Wąż parciany czerwony /strażak/ 2" 30m ze złączkami G70035 5

1"	20m
1"	30m
1"	50m
1"	100m



✗

Kod EAN

5901477112775

Kod EAN

5901477131585

Kod EAN

5901477112782

Kod EAN

5901477112799

GB Firehose
DE Feuerwehr
RU Пожарный рукав
CZ Požární hadice
SK Požiarna hadice
HU Locsolótömlő csatlakozóval
RO Furtun de incendiu

EKO	Kod produktu	
Wąż PCV 1" - 20m(niebieski-smell) 2 BARY	G70006	10
Wąż PCV 1" - 30m(niebieski-smell) 2 BARY	G70013	10
Wąż PCV 1" - 50m (niebieski-smell) 2 BARY	G70007	1
Wąż PCV 1" - 100m(niebieski-smell) 2 BARY	G70008	1

2"	20m
2"	30m
2"	50m
2"	100m



✗

Kod EAN

5901477112836

Kod EAN

5901477129032

Kod EAN

5901477112829

Kod EAN

5901477112805

GB Firehose
DE Feuerwehr
RU Пожарный рукав
CZ Požární hadice
SK Požiarna hadice
HU Locsolótömlő csatlakozóval
RO Furtun de incendiu

EKO	Kod produktu	
Wąż PCV 2" - 20m (niebieski-smell) 2 BARY	G70016	5
Wąż PCV 2" - 30m (niebieski-smell) 2 BARY	G70014	5
Wąż PCV 2" - 50m (niebieski-smell) 2 BARY	G70015	1
Wąż PCV 2" - 100m(niebieski-smell) 2 BARY	G70010	1

2"	20m
2"	50m
2"	100m

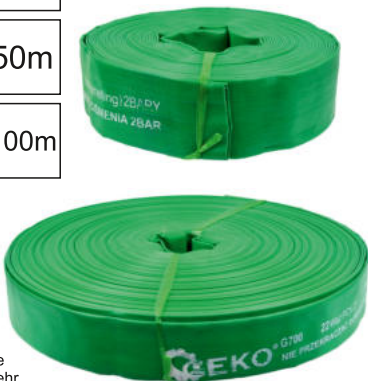

✗

Kod EAN

5901477136368

Kod EAN

5901477136375

Kod EAN

5901477136382

GB Firehose
DE Feuerwehr
RU Пожарный рукав
CZ Požární hadice
SK Požiarna hadice
HU Locsolótömlő csatlakozóval
RO Furtun de incendiu

EKO	Kod produktu	
Wąż PCV 2" 20m zielony 2 BARY(bezzapachowy)	G70020	5
Wąż PCV 2" 50m zielony 2 BARY(bezzapachowy)	G70021	1
#Wąż PCV 2" 100m zielony 2 BARY(bezzapachowy)	G70022	1

1"	25mm
2"	50mm

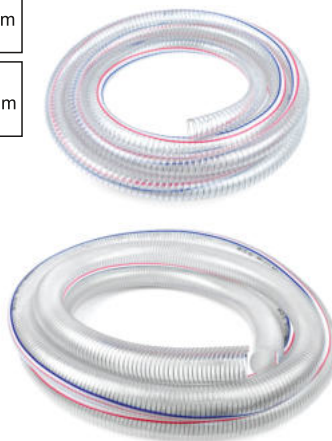

✗

Kod EAN

5901477161735

Kod EAN

5901477161742

GB Suction hose
DE Saugschlauch
RU Всасывающий шланг
CZ Sací hadice
SK Sacia hadica
HU Szívótömlő
RO Furtun de aspiratie

EKO	Kod produktu	
Wąż ssawny 1 cal 1" 25mm - wzmacniany drutem 5m	G70040	1
Wąż ssawny 2 cal 2" 50mm - wzmacniany drutem 5m	G70041	1

2"	20m
----	-----



✗

Kod EAN

5901477129803

GB Firehose
DE Feuerwehr
RU Пожарный рукав
CZ Požární hadice
SK Požiarna hadice
HU Locsolótömlő csatlakozóval
RO Furtun de incendiu

keltin	Kod produktu	
Wąż parciany 2" 20m ze złączkami KELTIN	K00150	2

2"	30m
----	-----



✗

Kod EAN

5901477129810

GB Firehose
DE Feuerwehr
RU Пожарный рукав
CZ Požární hadice
SK Požiarna hadice
HU Locsolótömlő csatlakozóval
RO Furtun de incendiu

keltin	Kod produktu	
Wąż parciany 2" 30m ze złączkami KELTIN	K00151	5

1"-2"



GB Adapter
DE Reduktion
RU Переходник
CZ Adaptér pro požární hadici
SK Adaptér pre požiarne hadicu
HU Csonkkapocs adapter
RO Adaptor pentru furtun de incendiu



5901477112843

Redukcja do węzła parciego 1"-2" Kod produktu **G70100** 100

2"-3"



GB Adapter
DE Reduktion
RU Переходник
CZ Adaptér pro požární hadici
SK Adaptér pre požiarne hadicu
HU Csonkkapocs adapter
RO Adaptor pentru furtun de incendiu



5901477112850

Redukcja do węzła 2"-3" Kod produktu **G70101** 45

2"



GB Adaptor for fire hose
DE Druchverbinderarmatur
RU Наконечник для шланга
CZ Adaptér pro požární hadici
SK Adaptér pre požiarne hadicu
HU Tömlőtoldó csonkkapocs
RO Adaptor pentru furtun de incendiu



5901477112867

Złączka węzła 2" Kod produktu **G70102** 50

2"



GB Adaptor for fire hose
DE Druchverbinderarmatur
RU Наконечник для шланга
CZ Adaptér pro požární hadici
SK Adaptér pre požiarne hadicu
HU Tömlőtoldó csonkkapocs
RO Adaptor pentru furtun de incendiu



5901477195099

Złączka węzła 2" 400g Kod produktu **G70102A** 50

2"



GB Adaptor for fire hose
DE Druchverbinderarmatur
RU Наконечник для шланга
CZ Adaptér pro požární hadici
SK Adaptér pre požiarne hadicu
HU Tömlőtoldó csonkkapocs
RO Adaptor pentru furtun de incendiu



5901477195105

Złączka węzła 2" 600g Kod produktu **G70102B** 40

2"



GB Adaptor for fire hose
DE Druchverbinderarmatur
RU Наконечник для шланга
CZ Adaptér pro požární hadici
SK Adaptér pre požiarne hadicu
HU Tömlőtoldó csonkkapocs
RO Adaptor pentru furtun de incendiu



5901477173851

Złączka strażacka do pompy/węzła 2" – gwint wewnętrzny Kod produktu **G70104** 150

2"



GB Adaptor for fire hose
DE Druchverbinderarmatur
RU Наконечник для шланга
CZ Adaptér pro požární hadici
SK Adaptér pre požiarne hadicu
HU Tömlőtoldó csonkkapocs
RO Adaptor pentru furtun de incendiu



5901477195112

Złączka strażacka do pompy/węzła 2" – gwint wewnętrzny 210g Kod produktu **G70104A** 100

2"



GB Adaptor for fire hose
DE Druchverbinderarmatur
RU Наконечник для шланга
CZ Adaptér pro požární hadici
SK Adaptér pre požiarne hadicu
HU Tömlőtoldó csonkkapocs
RO Adaptor pentru furtun de incendiu



5901477122309

Złączka strażacka do pompy/węzła 2" Kod produktu **G70105** 100

2"



GB Water cannon with bearing
DE Wasserkanone mit Lager
RU Водяная пушка с подшипником
CZ Vodní dělo s ložiskem
SK Vodné delo s ložiskom
HU Vízágyú csapágyazással
RO Tun de apă cu rulment



5901477171499

Prądownica strażacka – działko do wody 2" Kod produktu **G70106** 20

1"



GB Water cannon with bearing
DE Wasserkanone mit Lager
RU Водяная пушка с подшипником
CZ Vodní dělo s ložiskem
SK Vodné delo s ložiskom
HU Vízágyú csapágyazással
RO Tun de apă cu rulment



5901477173509

Prądownica strażacka – działko do wody 1" Kod produktu **G70107** 50

2"



GB Fire nozzle
DE Feuerlöschschlauchdüse
RU Пожарное сопло
CZ Požární tryska
SK Požiarna dýza
HU Tűzoltó fűvóka
RO Teava refulare



5901477173875

Prądownica strażacka do wody 2" Kod produktu **G70108** 25

1"



GB Fire nozzle
DE Feuerlöschschlauchdüse
RU Пожарное сопло
CZ Požární tryska
SK Požiarna dýza
HU Tűzoltó fűvóka
RO Teava refulare



5901477173882

Prądownica strażacka do wody 1" Kod produktu **G70109** 100

Plandeki / Tarpaulins



100g



100g



GB Tarpaulin
DE Plane
RU Тент
CZ Plachta
SK Plachta
HU Ponyva
RO Husă

GB Tarpaulin
DE Plane
RU Тент
CZ Plachta
SK Plachta
HU Ponyva
RO Husă

Kod EAN

5901477168963

Kod EAN

5901477168970

Kod EAN

5901477168987

Kod EAN

5901477168994

Kod EAN

5901477169007

Kod EAN

5901477169014

Kod EAN

5901477169021

EKO	Kod produktu	
Plandeka "kamuflač-moro" 1,83x3m 100gsm	G70610	30
Plandeka "kamuflač-moro" 3,66x3m 100gsm	G70611	15
Plandeka "kamuflač-moro" 3,66x4m 100gsm	G70612	12

EKO	Kod produktu	
Plandeka "kamuflač-moro" 5,49x4m 100gsm	G70613	8
Plandeka "kamuflač-moro" 5,49x6m 100gsm	G70614	5
Plandeka "kamuflač-moro" 5,49x8m 100gsm	G70615	4
Plandeka "kamuflač-moro" 5,49x10m 100gsm	G70616	3

wodoodporna
 łatwo zmywalna
 pleśniodporna
 łatwa w użyciu
 wyposażona w aluminiowe otwory do mocowania co 1 m
 tolerancja wymiaru +/- 5%



Kod EAN
 5901477124914
 Kod EAN
 5901477124921
 Kod EAN
 5901477113246
 Kod EAN
 5901477113253
 Kod EAN
 5901477113260
 Kod EAN
 5901477113277
 Kod EAN
 5901477113284
 Kod EAN
 5901477113291
 Kod EAN
 5903240385065
 Kod EAN
 5901477113314
 Kod EAN
 5901477113321

GB Tarpaulin
 DE Plane
 RU Тент
 CZ Plachta
 SK Plachta
 HU Ponyva
 RO Husă

BEKO	Kod produktu	
Plandeka 2x4m lekka/niebieska +/-5%	G01927	30
Plandeka 3x3m lekka/niebieska +/-5%	G01928	30
Plandeka 2x3m lekka/niebieska +/-5%	G01930	40
Plandeka 3x4m lekka/niebieska +/-5%	G01931	20
Plandeka 3x5m lekka/niebieska +/-5%	G01932	16
Plandeka 4x5m lekka/niebieska +/-5%	G01933	12
Plandeka 4x6m lekka/niebieska +/-5%	G01934	10
Plandeka 5x8m lekka/niebieska +/-5%	G01935	6
Plandeka 6x10m lekka/niebieska +/-5%	G01936	4
Plandeka 8x12m lekka/niebieska +/-5%	G01937	3
Plandeka 10x15m lekka/niebieska +/-5%	G01938	2

Kod EAN
 5901477113383
 Kod EAN
 5901477113390
 Kod EAN
 5901477113338
 Kod EAN
 5901477124938
 Kod EAN
 5901477113345
 Kod EAN
 5901477124945
 Kod EAN
 5901477113352
 Kod EAN
 5901477124952
 Kod EAN
 5901477113369
 Kod EAN
 5901477124969
 Kod EAN
 5901477117718

GB Tarpaulin
 DE Plane
 RU Тент
 CZ Plachta
 SK Plachta
 HU Ponyva
 RO Husă

BEKO	Kod produktu	
Plandeka 4x8m lekka/niebieska +/-5%	G01939	8
Plandeka 5x6m lekka/niebieska +/-5%	G01940	8
Plandeka 6x8m lekka/niebieska +/-5%	G01960	5
Plandeka 6x12m lekka/niebieska +/-5%	G01962	4
Plandeka 8x10m lekka/niebieska +/-5%	G01964	3
Plandeka 10x10m lekka/niebieska +/-5%	G01966	2
Plandeka 10x12m lekka/niebieska +/-5%	G01968	2
Plandeka 15x16m lekka/niebieska +/-5%	G01971	1
Plandeka 12x15m lekka/niebieska +/-5%	G01972	2
Plandeka 12x18m lekka/niebieska +/-5%	G01973	1
Plandeka 15x20m lekka/niebieska +/-5%	G01974	1

80g

wodoodporna
 łatwo zmywalna
 pleśniodoporna
 łatwa w użyciu
 wyposażona w aluminiowe otwory do mocowania co 1m
 gramatura 80g/m²



Kod EAN
 5901477124976
 Kod EAN
 5901477124983
 Kod EAN
 5901477124990
 Kod EAN
 5901477125003
 Kod EAN
 5901477125010
 Kod EAN
 5901477125027
 Kod EAN
 5901477125034
 Kod EAN
 5901477125041
 Kod EAN
 5901477125058
 Kod EAN
 5901477125065
 Kod EAN
 5901477125072

GB Tarpaulin
 DE Plane
 RU Тент
 CZ Plachta
 SK Plachta
 HU Ponyva
 RO Husă

EKO	Kod produktu	
Plandeka 2x3m gruba/zielona	G70305	30
Plandeka 2x4m gruba/zielona	G70306	20
Plandeka 3x3m gruba/zielona	G70310	20
Plandeka 3x4m gruba/zielona	G70311	15
Plandeka 3x5m gruba/zielona	G70312	12
Plandeka 4x5m gruba/zielona	G70321	9
Plandeka 4x6m gruba/zielona	G70322	8
Plandeka 4x8m gruba/zielona	G70324	6
Plandeka 5x6m gruba/zielona	G70332	6
Plandeka 5x8m gruba/zielona	G70334	5
Plandeka 6x8m gruba/zielona	G70342	4

Kod EAN
 5901477125089
 Kod EAN
 5901477125096
 Kod EAN
 5901477125102
 Kod EAN
 5901477125119
 Kod EAN
 5901477125126
 Kod EAN
 5901477125133
 Kod EAN
 5901477125140
 Kod EAN
 5901477125157
 Kod EAN
 5901477125164
 Kod EAN
 5901477125171
 Kod EAN
 5901477125188

GB Tarpaulin
 DE Plane
 RU Тент
 CZ Plachta
 SK Plachta
 HU Ponyva
 RO Husă

EKO	Kod produktu	
Plandeka 6x10m gruba/zielona	G70344	3
Plandeka 6x12m gruba/zielona	G70346	3
Plandeka 8x10m gruba/zielona	G70352	3
Plandeka 8x12m gruba/zielona	G70354	2
Plandeka 10x10m gruba/zielona	G70362	2
Plandeka 10x12m gruba/zielona	G70364	2
Plandeka 10x15m gruba/zielona	G70366	2
Plandeka 12x15m gruba/zielona	G70372	1
Plandeka 12x18m gruba/zielona	G70376	1
Plandeka 15x16m gruba/zielona	G70382	1
Plandeka 15x20m gruba/zielona	G70385	1

120g

wodoodporna
 łatwo zmywalna
 pleśnioodporna
 łatwa w użyciu
 wyposażona w aluminiowe otwory do mocowania co 1m
 gramatura 120g/m²



Kod EAN
 5901477125195
 Kod EAN
 5901477125201
 Kod EAN
 5901477125218
 Kod EAN
 5901477125225
 Kod EAN
 5901477125232
 Kod EAN
 5901477125249
 Kod EAN
 5901477125256
 Kod EAN
 5901477125263
 Kod EAN
 5901477125270
 Kod EAN
 5901477125287
 Kod EAN
 5901477125294

Kod EAN
 5901477125300
 Kod EAN
 5901477125317
 Kod EAN
 5901477125324
 Kod EAN
 5901477125331
 Kod EAN
 5901477125348
 Kod EAN
 5901477125355
 Kod EAN
 5901477125362
 Kod EAN
 5901477125379
 Kod EAN
 5901477125386
 Kod EAN
 5901477125393
 Kod EAN
 5901477125409

GB Tarpaulin
 DE Plane
 RU Тент
 CZ Plachta
 SK Plachta
 HU Ponyva
 RO Husă

GB Tarpaulin
 DE Plane
 RU Тент
 CZ Plachta
 SK Plachta
 HU Ponyva
 RO Husă

	Kod produktu	
Plandeka 2x3m mega gruba/szara 120G	G70505	20
Plandeka 2x4m mega gruba/szara 120G	G70506	15
Plandeka 3x3m mega gruba/szara 120G	G70510	14
Plandeka 3x4m mega gruba/szara 120G	G70511	10
Plandeka 3x5m mega gruba/szara 120G	G70512	8
Plandeka 4x5m mega gruba/szara 120G	G70521	5
Plandeka 4x6m mega gruba/szara 120G	G70522	5
Plandeka 4x8m mega gruba/szara 120G	G70524	4
Plandeka 5x6m mega gruba/szara 120G	G70532	4
Plandeka 5x8m mega gruba/szara 120G	G70534	4
Plandeka 6x8m mega gruba/szara 120G	G70542	4

	Kod produktu	
Plandeka 6x10m mega gruba/szara 120G	G70544	2
Plandeka 6x12m mega gruba/szara 120G	G70546	2
Plandeka 8x10m mega gruba/szara 120G	G70552	2
Plandeka 8x12m mega gruba/szara 120G	G70554	2
Plandeka 10x10m mega gruba/szara 120G	G70562	2
Plandeka 10x12m mega gruba/szara 120G	G70564	1
Plandeka 10x15m mega gruba/szara 120G	G70566	1
Plandeka 12x15m mega gruba/szara 120G	G70572	1
Plandeka 12x18m mega gruba/szara 120G	G70576	1
Plandeka 15x16m mega gruba/szara 120G	G70582	1
Plandeka 15x20m mega gruba/szara 120G	G70585	1

200g



wodoodporna
 łatwo zmywalna
 pleśńiodoporna
 łatwa w użyciu
 wyposażona w aluminiowe otwory do mocowania co 1m
 gramatura 200g/m²



Kod EAN

 5901477124631
 Kod EAN

 5901477124648
 Kod EAN

 5901477124655
 Kod EAN

 5901477124662
 Kod EAN

 5901477124679
 Kod EAN

 5901477124686
 Kod EAN

 5901477124693
 Kod EAN

 5901477124709
 Kod EAN

 5901477124716
 Kod EAN

 5901477124723
 Kod EAN

 5901477124730

Kod EAN

 5901477124747
 Kod EAN

 5901477124754
 Kod EAN

 5901477124761
 Kod EAN

 5901477124778
 Kod EAN

 5901477124785
 Kod EAN

 5901477124792
 Kod EAN

 5901477124808
 Kod EAN

 5901477124815
 Kod EAN

 5901477124822
 Kod EAN

 5901477124839
 Kod EAN

 5901477124846

GB Tarpaulin
 DE Plane
 RU Тент
 CZ Plachta
 SK Plachta
 HU Ponyva
 RO Husă

GB Tarpaulin
 DE Plane
 RU Тент
 CZ Plachta
 SK Plachta
 HU Ponyva
 RO Husă

BEKO	Kod produktu	
Plandeka 2x3m extra gruba/brązowa 200g	G70705	12
Plandeka 2x4m extra gruba/brązowa 200G	G70706	9
Plandeka 3x3m extra gruba/brązowa 200G	G70710	8
Plandeka 3x4m extra gruba/brązowa 200G	G70711	6
Plandeka 3x5m extra gruba/brązowa 200G	G70712	5
Plandeka 4x5m extra gruba/brązowa 200G	G70721	4
Plandeka 4x6m extra gruba/brązowa 200G	G70722	3
Plandeka 4x8m extra gruba/brązowa 200G	G70724	3
Plandeka 5x6m extra gruba/brązowa 200G	G70732	3
Plandeka 5x8m extra gruba/brązowa 200G	G70734	2
Plandeka 6x8m extra gruba/brązowa 200G	G70742	2

BEKO	Kod produktu	
Plandeka 6x10m extra gruba/brązowa 200G	G70744	2
Plandeka 6x12m extra gruba/brązowa 200G	G70746	1
Plandeka 8x10m extra gruba/brązowa 200G	G70752	1
Plandeka 8x12m extra gruba/brązowa 200G	G70754	1
Plandeka 10x10m extra gruba/brązowa 200G	G70762	1
Plandeka 10x12m extra gruba/brązowa 200G	G70764	1
Plandeka 10x15m extra gruba/brązowa 200G	G70766	1
Plandeka 12x15m extra gruba/brązowa 200G	G70772	1
Plandeka 12x18m extra gruba/brązowa 200G	G70776	1
Plandeka 15x16m extra gruba/brązowa 200G	G70782	1
Plandeka 15x20m extra gruba/brązowa 200G	G70785	1

Wiertnice do gleby / Augers



42.7cc	250 mm
moc nominalna 1.25kw	2800/min
25 : 1	950ml



GB Earth Auger + drill bit
DE Motorbohrer + Bohrer
RU бензин экскаватор / земля бурильщик + Сверло
CZ Půdní motorový vrták
SK Pôdny motorový vrták
HU Benzinmotoros földfúró
RO Motoburghiu



Kod EAN
5901477132025

John Gardener Kod produktu **Świder spaliny do gruntu + wiertło 25cm G81055 1/2cz.**

62cc	100 200 300 mm
moc nominalna 1.4kw	10000/min
25 : 1	1100ml
500 mm	



GB Earth Auger + drill bit
DE Motorbohrer + Bohrer
RU бензин экскаватор / земля бурильщик + Сверло
CZ Půdní motorový vrták
SK Pôdny motorový vrták
HU Benzinmotoros földfúró
RO Motoburghiu



Kod EAN
5901477160677

John Gardener Kod produktu **Świder spaliny + wiertła(10cm,20cm,30cm) + adapter 50cm G84020 4**

62cc	100 200 300 mm
moc nominalna 1.4kw	10000/min
25 : 1	1100ml
500 mm	



GB Earth Auger + drill bit
DE Motorbohrer + Bohrer
RU бензин экскаватор / земля бурильщик + Сверло
CZ Půdní motorový vrták
SK Pôdny motorový vrták
HU Benzinmotoros földfúró
RO Motoburghiu



Kod EAN
5901477160684

John Gardener Kod produktu **Świder spaliny(2os.) + wiertła(10,20,30cm) + adapter 50cm G84021 4**

62cc	320/min
moc nominalna 1.4kw	1100ml
25 : 1	



GB Earth Auger
DE Motorbohrer
RU бензин экскаватор / земля бурильщик
CZ Půdní motorový vrták
SK Pôdny motorový vrták
HU Benzinmotoros földfúró
RO Motoburghiu



Kod EAN
5901477160868

John Gardener Kod produktu **Świder spaliny (bez wiertel) G84024 1**

42.7cc
 250 mm
 moc nominalna 1.25kw
 2800/min
 25 : 1
 950ml



150 mm
 800 mm
 200 mm
 250 mm

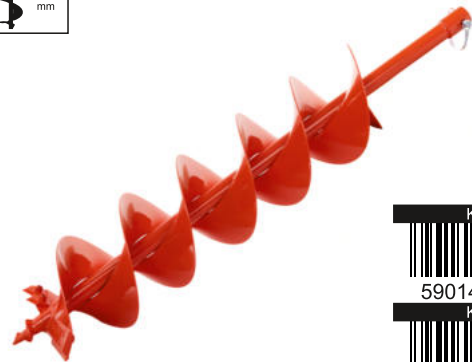

GB Earth Auger + drill bit
 DE Motorbohrer + Bohrer
 RU бензин экскаватор / земля бурильщик + Сверло
 CZ Půdní motorový vrták
 SK Pôdny motorový vrták
 HU Benzinmotoros földfúró
 RO Motoburghiu

Kod EAN
 5901477136276

John Gardener	Kod produktu	
Šwider spalinowy do gruntu + wiertło 25cm	H00655	1/2cz.

Kod EAN
 5901477178771
 Kod EAN
 5901477178788
 Kod EAN
 5901477178795

GB Drill
 DE Bohrer für Erdbohrer Zipper
 RU Сверло для мотобура
 CZ Nástavec na zemní vrták
 SK Nástavec na zemný vrták
 HU Náhradni vrták k zemnímu vrtáku
 RO Burghiu

John Gardener	Kod produktu	
Profesjonalne wiertło do świda spalinowego 15x80cm G81056K	G81056K	1
Profesjonalne wiertło do świda spalinowego 20x80cm G81056L	G81056L	1
Profesjonalne wiertło do świda spalinowego 25x80cm G81056M	G81056M	1

300 mm
 500 mm



Kod EAN
 5901477143458
 Kod EAN
 5901477160844

GB Adapter for earth auger
 DE Adapter für Motorbohrer
 RU Адаптер для Мотобура
 CZ Prodlužovací nástavec pro zemní vrták
 SK Predĺžovací nástavec pre zemný vrták
 HU Fúrészár
 RO Adaptor

John Gardener	Kod produktu	
Adapter do świda spalinowego 30cm	G81056	20
Adapter do świda spalinowego 50cm	G84022	20

40x450 mm
 50x220 mm
 80x350 mm
 HEX



Kod EAN
 5901477173424
 Kod EAN
 5901477170744
 Kod EAN
 5901477173431

GB Gimlet to the soil
 DE Handbohrer für den Erdboden
 RU Ручной почвенный бур
 CZ Ruční vrták do půdy
 SK Ručné vrták do pôdy
 HU Kézi talajfúró
 RO Sfredel manual pt. pământ

John Gardener	Kod produktu	
Wiertło ogrodowe – świder do gleby 4x45cm	G72071	50
Wiertło ogrodowe – świder do gleby 5x22cm	G72072	40
Wiertło ogrodowe – świder do gleby 8x35cm	G72073	30

60 mm
 800 mm
 100 mm
 150 mm
 200 mm
 800 mm
 250 mm
 300 mm

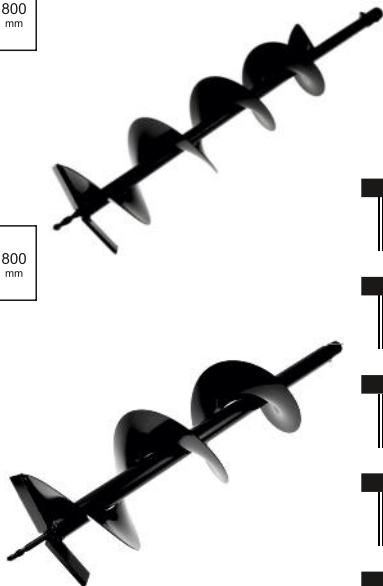

Kod EAN
 5901477160875
 Kod EAN
 5901477143465
 Kod EAN
 5901477143472
 Kod EAN
 5901477143489
 Kod EAN
 5901477143496
 Kod EAN
 5901477160882

GB Drill
 DE Bohrer für Erdbohrer Zipper
 RU Сверло для мотобура
 CZ Nástavec na zemní vrták
 SK Nástavec na zemný vrták
 HU Náhradni vrták k zemnímu vrtáku
 RO Burghiu

John Gardener	Kod produktu	
Wiertło do świda spalinowego 6x80cm	G81056F	4
Wiertło do świda spalinowego 10x80cm	G81056A	10
Wiertło do świda spalinowego 15x80cm	G81056B	8
Wiertło do świda spalinowego 20x80cm	G81056C	6
Wiertło do świda spalinowego 25x80cm	G81056D	4
Wiertło do świda spalinowego 30x80cm	G81056G	2

100x300 mm
 80x600 mm
 100x600 mm
 HEX



Kod EAN
 5901477189586
 Kod EAN
 5901477189593
 Kod EAN
 5901477189609

GB Gimlet to the soil
 DE Handbohrer für den Erdboden
 RU Ручной почвенный бур
 CZ Ruční vrták do půdy
 SK Ručné vrták do pôdy
 HU Kézi talajfúró
 RO Sfredel manual pt. pământ

John Gardener	Kod produktu	
Wiertło ogrodowe – świder do gleby 10x30cm	G72081	40
Wiertło ogrodowe – świder do gleby 8x60cm	G72082	40
Wiertło ogrodowe – świder do gleby 10x60cm	G72083	30



GB Earth auger shock absorber
DE Stoßdämpfer für Erdbohrer
RU Амортизатор земляного бура
CZ Tlumič zemního šneku
SK Tlmič zemného šneku
HU Földcsiga lengéscsillapító
RO Амортизатор земляного бура

Kod EAN
5901477180965



John Gardener Kod produktu
Amortyzator – sprężyna do świda spalinowego 210/20mm G81056X 6



GB Reduce speed asy for earth auger
DE Führungsschiene
RU Передача для бензин экскаватора
CZ Převodovka pro zemní vrták
SK Prevodovka pre zemný vrták
HU Földfúró áttét
RO Transmisie

Kod EAN
5901477160851

John Gardener Kod produktu
Przekładnia świda spalinowego typu prostego G84023 10

GB Gimlet to the soil
DE Handbohrer für den Erdboden
RU Ручной почвенный бур
CZ Ruční vrták do půdy
SK Ručné vrták do pôdy
HU Kézi talajfúró
RO Sfredel manual pt. pământ

110 mm
140 mm
170 mm
200 mm

Kod EAN
5901477140440
Kod EAN
5901477140457
Kod EAN
5901477140464
Kod EAN
5901477140471

John Gardener Kod produktu
Świder ręczny do gleby 110mm G66511 100
Świder ręczny do gleby 140mm G66512 100
Świder ręczny do gleby 170mm G66513 100
Świder ręczny do gleby 200mm G66514 50

Łopaty, szpadle, widły i grabie / Shovels, spades, forks and rakes





HARD LINE

120cm
28cm
20cm

GB Spade
DE Rodespaten
RU Застып
CZ Lisovaný rýč kalená
SK Lisovaný rýľ kalená
HU Ásó, sajított-edzett
RO Hârteț cu coadă

Kod EAN
5903418301637

EKO Kod produktu
Szpadel prosty 120cm HARD-LINE G66545 6





HARD LINE

120cm
28cm
20cm

GB Spade
DE Rodespaten
RU Застып
CZ Lisovaný rýč kalená
SK Lisovaný rýľ kalená
HU Ásó, sajított-edzett
RO Hârteț cu coadă

Kod EAN
5903418301644

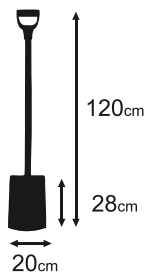
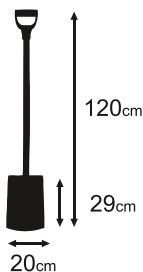
EKO Kod produktu
Szpadel ostry 120cm HARD-LINE G66546 6



GB Spade
DE Rodespaten
RU Застып
CZ Lisovaný rýč kalená
SK Lisovaný rýľ kalená
HU Ásó, sajtolt-edzett
RO Hârleț cu coadă



Kod EAN
5901477140341

Szpadel prosty trzon metalowy Kod produktu **G66501** **5**

GB Spade
DE Rodespaten
RU Застып
CZ Lisovaný rýč kalená
SK Lisovaný rýľ kalená
HU Ásó, sajtolt-edzett
RO Hârleț cu coadă



Kod EAN
5901477140358

Szpadel ostry trzon metalowy Kod produktu **G66502** **5**

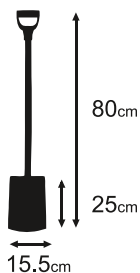
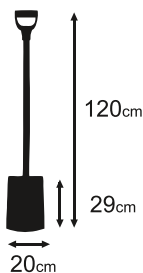

GB Spade
DE Rodespaten
RU Застып
CZ Lisovaný rýč kalená
SK Lisovaný rýľ kalená
HU Ásó, sajtolt-edzett
RO Hârleț cu coadă



Kod EAN
5901477140372

Szpadel ogrodowy wzmacniony oprawiony Kod produktu **G66504** **5**

GB Spade
DE Rodespaten
RU Застып
CZ Lisovaný rýč kalená
SK Lisovaný rýľ kalená
HU Ásó, sajtolt-edzett
RO Hârleț cu coadă



Kod EAN
5901477140426

Saperka trzon metalowy Kod produktu **G66509** **5**

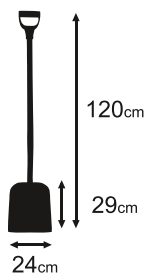
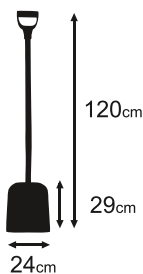

GB Shovel
DE Schaufel
RU Лопата совковая песочная
CZ Osazený rýč pískový
SK Osadený rýľ pieskový
HU Homoklapát
RO Lopată pt. nisip



Kod EAN
5903418301651

Łopata do piasku 120cm HARD-LINE Kod produktu **G66547** **6**

GB Shovel
DE Schaufel
RU Лопата совковая песочная
CZ Osazený rýč pískový
SK Osadený rýľ pieskový
HU Homoklapát
RO Lopată pt. nisip



Kod EAN
5903418301668

Łopata węglowa 120cm HARD-LINE Kod produktu **G66548** **6**

125cm
26cm
24cm

GB Shovel
DE Schaufel
RU Лопата совковая песочная
CZ Osazený rýč pískový
SK Osadený rýč pieskový
HU Homoklapát
RO Lopată pt. nisip

Kod EAN
5901477140334

Łopata piaskowa trzon metalowy Kod produktu **G66500** 5

124cm
33cm
24cm

GB Shovel
DE Schaufel
RU Лопата совковая песочная
CZ Osazený rýč pískový
SK Osadený rýč pieskový
HU Homoklapát
RO Lopată pt. nisip

Kod EAN
5901477140433

Łopata węglowa trzon metalowy Kod produktu **G66510** 10

120cm
36cm
28cm

GB Shovel
DE Schaufel
RU Лопата совковая песочная
CZ Osazený rýč pískový
SK Osadený rýč pieskový
HU Homoklapát
RO Lopată pt. nisip

Kod EAN
5901477144936

Łopata węglowa trzon drewniany DUŻA Kod produktu **G66520** 10

150cm
48cm
37cm

GB Shovel
DE Schaufel
RU Лопата совковая песочная
CZ Osazený rýč pískový
SK Osadený rýč pieskový
HU Homoklapát
RO Lopată pt. nisip

Kod EAN
5903418301712

Łopata aluminiowa do zboża 150cm HARD-LINE Kod produktu **G66553** 6

124cm
29.5cm
24.5cm

GB Shovel
DE Schaufel
RU Лопата совковая песочная
CZ Osazený rýč pískový
SK Osadený rýč pieskový
HU Homoklapát
RO Lopată pt. nisip

Kod EAN
5901477172304

Łopata uniwersalna lekka oprawna 125cm Kod produktu **G66525** 6

145 cm
24 cm
12 cm
13,5 cm

GB Post hole digger
DE Erdlochbohrer
RU Ямокопатель
CZ Jamkovač
SK Jamkovač
HU Gödörfúró
RO Săpător de gropi

Kod EAN
5903418301736

Dołownik 145cm HARD-LINE Kod produktu **G66555** 6





GB Garden hoe
 DE Garten Handhacke
 RU Тяпка
 CZ Motyčka
 SK Motyčka
 HU Kerti kapa
 RO Sapaliga

 Kod EAN
 5901477172267

 Kod produktu 
Motyka serce - pazurki dł. 100cm **G66521** **5**





GB Garden hoe
 DE Garten Handhacke
 RU Тяпка
 CZ Motyčka
 SK Motyčka
 HU Kerti kapa
 RO Sapaliga

 Kod EAN
 5901477172274



 Kod produktu 
Motyka łopotka - pazurki dł. 100cm **G66522** **5**





GB Garden hoe
 DE Garten Handhacke
 RU Тяпка
 CZ Motyčka
 SK Motyčka
 HU Kerti kapa
 RO Sapaliga

 Kod EAN
 5901477172281

 Kod produktu 
Motyka trapezowa sz.16cm dł. 100cm **G66523** **5**







HARD LINE



GB Rake
 DE Rechen
 RU Грабли
 CZ Hrábě
 SK Hrable
 HU Gereblye
 RO Greblă

 Kod EAN
 5903418301705



 Kod produktu 
Grabie metalowe 150cm 14z HARD-LINE **G66552** **6**











GB Rake
 DE Rechen
 RU Грабли
 CZ Hrábě
 SK Hrable
 HU Gereblye
 RO Greblă

 Kod EAN
 5901477140389



 Kod produktu 
Grabie 12-zębne oprawione **G66505** **5**









GB Rake
 DE Rechen
 RU Грабли
 CZ Hrábě
 SK Hrable
 HU Gereblye
 RO Greblă

 Kod EAN
 5901477140396

 Kod produktu 
Grabie 14-zębne oprawione **G66506** **5**



GB Rake
DE Rechen
RU Грабли
CZ Hrábě
SK Hrable
HU Gereblye
RO Greblă



Kod EAN
5901477140402

Grabie 16-zębne oprawione Kod produktu **G66507** 5

GB Rake
DE Rechen
RU Грабли
CZ Hrábě
SK Hrable
HU Gereblye
RO Greblă



Kod EAN
5901477140419

Grabie 18-zębne oprawione Kod produktu **G66508** 5



HARD
LINE



HARD
LINE



GB Digging fork
DE Grabegabel
RU Вилы свекловичные кованые
CZ Zahradnické vidlice
SK Záhradnicke vidlica
HU Vasvilla
RO Furcă pt. grădină



Kod EAN
5903418301675

Widły do siana 120cm HARD-LINE Kod produktu **G66549** 6

GB Digging fork
DE Grabegabel
RU Вилы свекловичные кованые
CZ Zahradnické vidlice
SK Záhradnicke vidlica
HU Vasvilla
RO Furcă pt. grădină



Kod EAN
5903418301682

Widły ogrodnicze 120cm HARD-LINE Kod produktu **G66550** 6

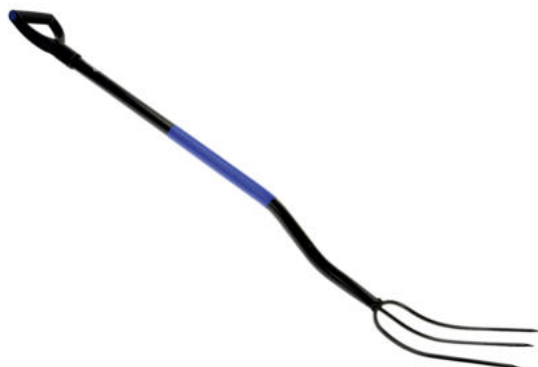

GB Digging fork
DE Grabegabel
RU Вилы свекловичные кованые
CZ Zahradnické vidlice
SK Záhradnicke vidlica
HU Vasvilla
RO Furcă pt. grădină



Kod EAN
5901477144844

Widły gospodarcze 3-zębne trzon metalowy Kod produktu **G66515** 5

GB Digging fork
DE Grabegabel
RU Вилы свекловичные кованые
CZ Zahradnické vidlice
SK Záhradnicke vidlica
HU Vasvilla
RO Furcă pt. grădină



Kod EAN
5901477144851

Widły gospodarcze 4-zębne trzon metalowy Kod produktu **G66516** 5



GB Digging fork
DE Grabegabel
RU Вилы свекловичные кованые
CZ Zahradnické vidlice
SK Záhradnické vidlica
HU Vasvilla
RO Furcă pt. grădină



Kod EAN
5901477191671

Widły gospodarcze 4-zębne trzon metalowy 135cm G66540 6

GB Digging fork
DE Grabegabel
RU Вилы свекловичные кованые
CZ Zahradnické vidlice
SK Záhradnické vidlica
HU Vasvilla
RO Furcă pt. grădină



Kod EAN
5901477144868

Widły ogrodowe trzon metalowy G66517 5



GB Digging fork
DE Grabegabel
RU Вилы свекловичные кованые
CZ Zahradnické vidlice
SK Záhradnické vidlica
HU Vasvilla
RO Furcă pt. grădină



Kod EAN
5901477191688

Widły – gable gospodarcze 9-zębne trzon drewniany 135cm G66543 6

GB Digging fork
DE Grabegabel
RU Вилы свекловичные кованые
CZ Zahradnické vidlice
SK Záhradnické vidlica
HU Vasvilla
RO Furcă pt. grădină



Kod EAN
5901477129162

Widły gospodarcze 4-zębne zielone G72050 12



GB Rake
DE Rechen
RU Грабли
CZ Hrábě
SK Hrable
HU Gereblye
RO Greblă



Kod EAN
5901477144875

Grabie ergo 14-zębne trzon metalowy G66518 1

GB Rake
DE Rechen
RU Грабли
CZ Hrábě
SK Hrable
HU Gereblye
RO Greblă



Kod EAN
5901477144882

Grabie ergo 16-zębne trzon metalowy G66519 1

18



GB Rake
DE Rechen
RU Грабли
CZ Hrábě
SK Hrable
HU Gereblye
RO Greblă



Grabie do siana 18 zębne (bez trzonka) G66534 5

L ilość zębów 20



GB Spring rake
DE Landschaftsbesen
RU Грабли веерные
CZ Hrabičky
SK Hrabičky
HU Kerti gereblye
RO Grebla de gradina



Grabie do liści L (bez trzonka - montaż uniwersalny) G66532 1

M ilość zębów 23



GB Spring rake
DE Landschaftsbesen
RU Грабли веерные
CZ Hrabičky
SK Hrabičky
HU Kerti gereblye
RO Grebla de gradina



Grabie do liści M (bez trzonka - montaż uniwersalny) G66531 70

XL ilość zębów 27



GB Spring rake
DE Landschaftsbesen
RU Грабли веерные
CZ Hrabičky
SK Hrabičky
HU Kerti gereblye
RO Grebla de gradina



Grabie do liści XL (bez trzonka - montaż uniwersalny) G66533 1

140 cm



GB Wooden handle
DE Schaufelstiel P-Griff
RU Черенок для лопат
CZ Násada na lopatu
SK Násada na lopatu
HU Lapátnyel
RO Coada de lopata cu maner



Trzonek drewniany z mocowaniem KLIK (grabie do liści) G66530 5

22



GB Rake
DE Rechen
RU Грабли
CZ Hrábě
SK Hrable
HU Gereblye
RO Greblă



Grabie metalowe wachlarzowe 150cm 22z HARD-LINE G66551 6

15



GB Rake
DE Rechen
RU Грабли
CZ Hrábě
SK Hrable
HU Gereblye
RO Greblă



Grabie wachlarzowe regulowane metalowe z trzonkiem G66535 6

22



GB Rake
DE Rechen
RU Грабли
CZ Hrábě
SK Hrable
HU Gereblye
RO Greblă



Grabie metalowe wachlarzowe 44x39cm G66536 36

Łopaty do śniegu / Snow Shovels

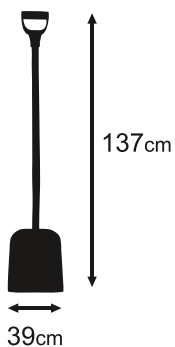
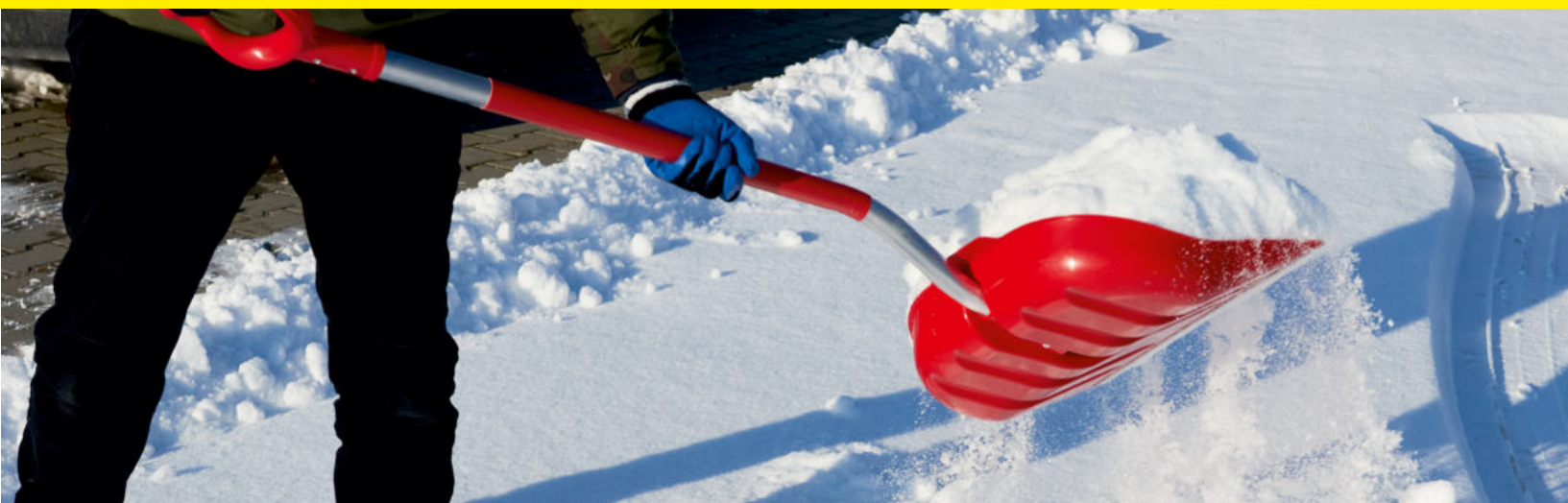

GB Shovel
DE Kohlschaufel
RU Лопата угольная
CZ Úhlový rýč číslo
SK Úhlový rýč číslo
HU Szeneslapát
RO Lopată pt. cărbune



Kod EAN
5901497400357

Łopata do śniegu plastikowa /alumiunowy całoroczna D00001 4

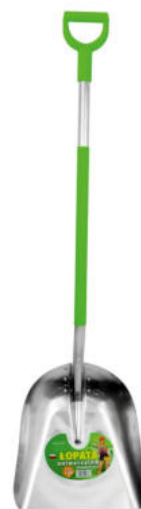
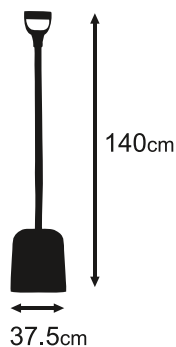

GB Shovel
DE Kohlschaufel
RU Лопата угольная
CZ Úhlový rýč číslo
SK Úhlový rýč číslo
HU Szeneslapát
RO Lopată pt. cărbune



Kod EAN
5901497400838

Łopata uniwersalna aluminiowa do zboża śniegu D00002 3

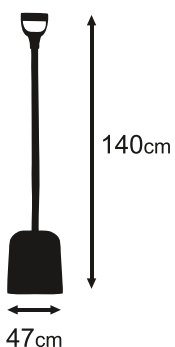

GB Shovel
DE Kohlschaufel
RU Лопата угольная
CZ Úhlový rýč číslo
SK Úhlový rýč číslo
HU Szeneslapát
RO Lopată pt. cărbune



Kod EAN
5901497400012

Łopata do śniegu aluminiowa BIG D00003 2

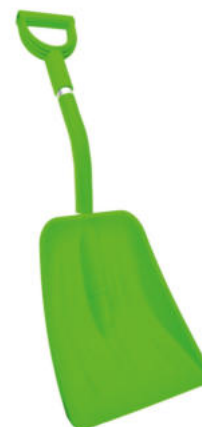
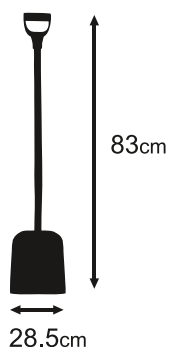

GB Shovel
DE Kohlschaufel
RU Лопата угольная
CZ Úhlový rýč číslo
SK Úhlový rýč číslo
HU Szeneslapát
RO Lopată pt. cărbune



Kod EAN
5901497400197

Łopata śniegowa samochodowa D00004 1

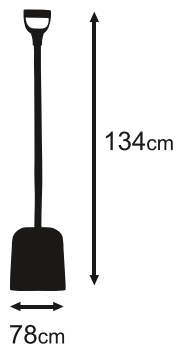
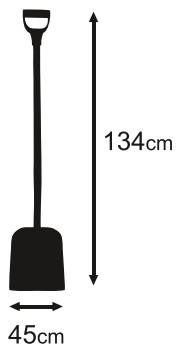

GB Shovel
DE Kohlschaufel
RU Лопата угольная
CZ Úhlový rýč číslo
SK Úhlový rýč číslo
HU Szeneslapát
RO Lopată pt. cărbune



Kod EAN
5901497400845

Łopata do śniegu AL MIX D00005 5

GB Shovel
DE Kohlschaufel
RU Лопата угольная
CZ Úhlový rýč číslo
SK Úhlový rýč číslo
HU Szeneslapát
RO Lopată pt. cărbune



Kod EAN
5901497400852

Zgarniacz do śniegu "rodzinny" D00006 3

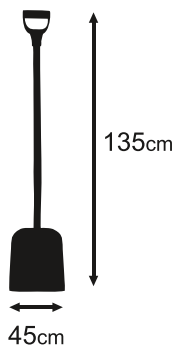

GB Shovel
DE Kohlschaufel
RU Лопата угольная
CZ Úhlový rýč číslo
SK Úhlový rýč číslo
HU Szeneslapát
RO Lopată pt. cărbune



Kod EAN
5901477183997

Łopata uniwersalna 45cm do śniegu D00008 10



GB Shovel handle
DE Schaufelstiel
RU Ручка лопаты
CZ Rukojeť lopaty
SK Rukoväť lopaty
HU Lapát nyél
RO Mâner de lopată



Kod EAN
5901477158148

Rączka do łopaty fi 32mm D00007 1



GB Snow roof rake
DE Schneedachrechen
RU Грабли для снега на крыше
CZ Sněhové střešní hrábě
SK Sněhové střešné hrable
HU Hótető gereblye
RO Grebla pentru acoperiș de zăpadă



Kod EAN
5901477198267

Łopata – zgarniacz śniegu do dachu 5,7m (61,5x14cm) D00009 1



GB Snow roof rake
DE Schneedachrechen
RU Грабли для снега на крыше
CZ Sněhové střešní hrábě
SK Sněhové střešné hrable
HU Hótető gereblye
RO Grebla pentru acoperiș de zăpadă



Kod EAN
5901477198274

Łopata – zgarniacz śniegu do dachu 7,5m (61,5x14cm) D00010 1

Małe narzędzia ogrodnicze

/ Small gardening tools



GB Wide garden trowel
 DE Breite Gartenschaufel
 RU Широкий садовый совок
 CZ Široká zahradní lopatka
 SK Široká záhradná lopatka
 HU Széles kerti lapátka
 RO Lopățiță de grădină lată



John Gardener
Łopátka ogrodnicza szeroka G72040 24/96



GB Narrow garden trowel
 DE Schmale Gartenschaufel
 RU Узкий садовый совок
 CZ Úzká zahradní lopatka
 SK Úzka záhradná lopatka
 HU Keskeny kerti lapátka
 RO Lopățiță de grădină îngustă



John Gardener
Łopátka ogrodnicza wąska G72041 24/96



GB Garden hand cultivator
 DE Gartenkralle
 RU Садовые рыхлители
 CZ Zahradní drápky
 SK Záhradné pazúrky
 HU Kerti karmok
 RO Gheare de grădină



John Gardener
Pazurki ogrodnicze G72042 24/96

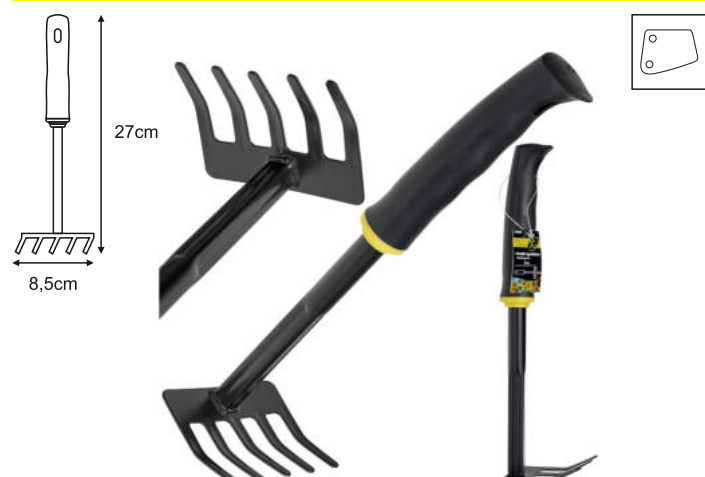

GB Garden rake
 DE Gartenrechen
 RU Садовые грабельки
 CZ Zahradní hrábě
 SK Záhradné hrabličky
 HU Kerti gereblye
 RO Greblă de grădină



John Gardener
Grabki ogrodnicze G72043 24/96



GB Garden rake
 DE Gartenrechen
 RU Садовые грабельки
 CZ Zahradní hrábě
 SK Záhradné hrabličky
 HU Kerti gereblye
 RO Greblă de grădină



John Gardener
Motyczka ogrodnicza dwustronna z pazurkami G72044 24/96



GB Garden broom rake
 DE Gartenbesenrechen
 RU Садовая метла-грабли
 CZ Zahradní koště-hrábě
 SK Záhradná metla-hrable
 HU Kerti seprűgereblye
 RO Mătură-greblă de grădină



Kod EAN
5901477197963

John Gardener
Miotło-grabki ogrodnicze

Kod produktu
G72045 24/96



GB Garden weeder
 DE Garten-Unkrautstecher
 RU Садовый удалитель сорняков
 CZ Zahradní odstraňovač plevelu
 SK Záhradný odstraňovač buriny
 HU Kerti gyomkiszedő
 RO Extractor de buruieni pentru grădină



Kod EAN
5901477197970

John Gardener
Wycinak ogrodniczy do chwastów

Kod produktu
G72046 24/96

Miotły i szczotki / Brooms & Brushes



GB Broom
 DE Strassenbesen
 RU Метла
 CZ Metla
 SK Metla
 HU Partvis
 RO Matură



Kod EAN
5901477134166

John Gardener
Ulicówka 30cm

Kod produktu
G66037 10



GB Broom
 DE Strassenbesen
 RU Метла
 CZ Metla
 SK Metla
 HU Partvis
 RO Matură



Kod EAN
5901477134173

John Gardener
Ulicówka 40cm

Kod produktu
G66038 10

50
cm



GB Broom
DE Strassenbesen
RU Метла
CZ Metla
SK Metla
HU Partvis
RO Matura



Kod EAN
5901477134180

Ulicówka 50cm Kod produktu **G66039** 10

60
cm



GB Broom
DE Strassenbesen
RU Метла
CZ Metla
SK Metla
HU Partvis
RO Matura



Kod EAN
5901477134197

Ulicówka 60cm Kod produktu **G66040** 10

40
cm



GB Broom
DE Strassenbesen
RU Метла
CZ Metla
SK Metla
HU Partvis
RO Matura



Kod EAN
5901477189326

Ulicówka 40cm - ze skrobakiem Kod produktu **G66038-1** 10

25cm



GB Broom
DE Strassenbesen
RU Метла
CZ Metla
SK Metla
HU Partvis
RO Matura



Kod EAN
5901477194689

Miotła gospodarcza SORGO 25cm Kod produktu **G66051** 1

30
cm



GB Broom
DE Strassenbesen
RU Метла
CZ Metla
SK Metla
HU Partvis
RO Matura



Kod EAN
5901477194696

Miotła gospodarcza SORGO 30cm Kod produktu **G66052** 1

35x85mm



GB Brush for footpaths
DE Bürste für Gehwege
RU Щетка для пешеходных дорожек
CZ Kartáč na pěšinky
SK Keňa na chodníky
HU Kefe gyalogutakhoz
RO Perie pentru poteci



Kod EAN
5901477181993

Szczotka druciana ze skrobakiem do kostki brukowej, drewno Kod produktu **K00036** 25

35x80mm



GB Brush for footpaths
DE Bürste für Gehwege
RU Щетка для пешеходных дорожек
CZ Kartáč na pěšinky
SK Keňa na chodníky
HU Kefe gyalogutakhoz
RO Perie pentru poteci



Kod EAN
5901477182006

Szczotka druciana ze skrobakiem do kostki brukowej, plast. Kod produktu **K00037** 10

Rękawice / Gloves



Kod EAN
5903418306137

Kod EAN
5903418306144

Kod EAN
5903418306151

Kod EAN
5903418306168

GB Kids' protective gloves
DE Kinder-Schutzhandschuhe
RU Детские защитные перчатки
CZ Dětské ochranné rukavice
SK Detské ochranné rukavice
HU Gyermek védőkesztyű
RO Mănuși de protecție pentru copii

Kod produktu	Opakowanie
Rękawice ochronne dla dzieci, rozmiar 2 (2-4 lata)	G75060 12/240
Rękawice ochronne dla dzieci, rozmiar 3 (5-8 lata)	G75061 12/240
Rękawice ochronne dla dzieci, rozmiar 4 (6-9 lata)	G75062 12/240
Rękawice ochronne dla dzieci, rozmiar 5 (8-12 lata)	G75063 12/240

rozmiar/size
9



Opakowanie
12 par

GB Working gloves
DE Arbeitshandschuh
RU Рабочие перчатки
CZ Pracovní rukavice
SK Pracovné rukavice
HU Védőkesztyű
RO Mănuși de lucru

Kod EAN
5901477122255

Kod produktu
Rękawice wampirki rozmiar 9/czerwone/ G73502A 600

rozmiar/size
9



Opakowanie
12 par

GB Working gloves
DE Arbeitshandschuh
RU Рабочие перчатки
CZ Pracovní rukavice
SK Pracovné rukavice
HU Védőkesztyű
RO Mănuși de lucru

Kod EAN
5901477131974

Kod produktu
Rękawice wampirki rozmiar 9/niebieskie/ G73502C 600

rozmiar/size
9



Opakowanie
12 par

GB Working gloves
DE Arbeitshandschuh
RU Рабочие перчатки
CZ Pracovní rukavice
SK Pracovné rukavice
HU Védőkesztyű
RO Mănuși de lucru

Kod EAN
5901477147128

Kod produktu
Rękawice robocze dziane naturalne G73503 600

rozmiar/size
9



Opakowanie
12 par

GB Working gloves
DE Arbeitshandschuh
RU Рабочие перчатки
CZ Pracovní rukavice
SK Pracovné rukavice
HU Védőkesztyű
RO Mănuși de lucru

Kod EAN
5901477147135

Kod produktu
Rękawice robocze dziane naturalne nakrapiane G73504 600

rozmiar/size
6



Opakowanie
12 par

GB Working gloves
DE Arbeitshandschuh
RU Рабочие перчатки
CZ Pracovní rukavice
SK Pracovné rukavice
HU Védőkesztyű
RO Mănuși de lucru

Kod EAN
5901477178979

Kod produktu
Rękawice robocze ogrodowe damskie r.6 G73507 300

rozmiar/size
8



Opakowanie
12 par

GB Working gloves
DE Arbeitshandschuh
RU Рабочие перчатки
CZ Pracovní rukavice
SK Pracovné rukavice
HU Védőkesztyű
RO Mănuși de lucru

Kod EAN
5901477122316

Kod produktu
Rękawice ochronne GEKO r.8/czarne/ G73511 300

rozmiar/size
9



Opakowanie
12 par

GB Working gloves
DE Arbeitshandschuh
RU Рабочие перчатки
CZ Pracovní rukavice
SK Pracovné rukavice
HU Védőkesztyű
RO Mănuși de lucru

Kod EAN
5901477131981

Kod produktu
Rękawice ochronne GEKO r.9/czarne/ G73512 300

rozmiar/size
10



Opakowanie
12 par

GB Working gloves
DE Arbeitshandschuh
RU Рабочие перчатки
CZ Pracovní rukavice
SK Pracovné rukavice
HU Védőkesztyű
RO Mănuși de lucru

Kod EAN
5901477122330

Kod produktu
Rękawice ochronne GEKO r.10/czarne/ G73513 300

rozmiar/size **8**



Opakowanie **12** par

GB Working gloves
DE Arbeitshandschuh
RU Рабочие перчатки
CZ Pracovní rukavice
SK Pracovné rukavice
HU Védőkesztyű
RO Mănuși de lucru

Kod EAN
5901477178474

Kod produktu **G73521** **300**

Rękawice ochronne GEKO r.8/biało-szare/

rozmiar/size **9**



Opakowanie **12** par

GB Working gloves
DE Arbeitshandschuh
RU Рабочие перчатки
CZ Pracovní rukavice
SK Pracovné rukavice
HU Védőkesztyű
RO Mănuși de lucru

Kod EAN
5901477122347

Kod produktu **G73522** **300**

Rękawice ochronne GEKO r.9/biało-szare/

rozmiar/size **10**



Opakowanie **12** par

GB Working gloves
DE Arbeitshandschuh
RU Рабочие перчатки
CZ Pracovní rukavice
SK Pracovné rukavice
HU Védőkesztyű
RO Mănuși de lucru

Kod EAN
5901477122354

Kod produktu **G73523** **300**

Rękawice ochronne GEKO r.10/biało-szare/

rozmiar/size **7**



Opakowanie **12** par

GB Working gloves
DE Arbeitshandschuh
RU Рабочие перчатки
CZ Pracovní rukavice
SK Pracovné rukavice
HU Védőkesztyű
RO Mănuși de lucru

Kod EAN
5901477178481

Kod produktu **G73530** **240**

Rękawice ochronne GEKO r.7/latex czerwone/

rozmiar/size **8**



Opakowanie **12** par

GB Working gloves
DE Arbeitshandschuh
RU Рабочие перчатки
CZ Pracovní rukavice
SK Pracovné rukavice
HU Védőkesztyű
RO Mănuși de lucru

Kod EAN
5901477122361

Kod produktu **G73531** **240**

Rękawice ochronne GEKO r.8/latex czerwone/

rozmiar/size **9**



Opakowanie **12** par

GB Working gloves
DE Arbeitshandschuh
RU Рабочие перчатки
CZ Pracovní rukavice
SK Pracovné rukavice
HU Védőkesztyű
RO Mănuși de lucru

Kod EAN
5901477122378

Kod produktu **G73532** **240**

Rękawice ochronne GEKO r.9/latex czerwone/

rozmiar/size **10**



Opakowanie **12** par

GB Working gloves
DE Arbeitshandschuh
RU Рабочие перчатки
CZ Pracovní rukavice
SK Pracovné rukavice
HU Védőkesztyű
RO Mănuși de lucru

Kod EAN
5901477122385

Kod produktu **G73533** **240**

Rękawice ochronne GEKO r.10/latex czerwone/

rozmiar/size **11**



Opakowanie **12** par

GB Working gloves
DE Arbeitshandschuh
RU Рабочие перчатки
CZ Pracovní rukavice
SK Pracovné rukavice
HU Védőkesztyű
RO Mănuși de lucru

Kod EAN
5901477178498

Kod produktu **G73534** **240**

Rękawice ochronne GEKO r.11/latex czerwone/

rozmiar/size **9**



Opakowanie **12** par

GB Working gloves
DE Arbeitshandschuh
RU Рабочие перчатки
CZ Pracovní rukavice
SK Pracovné rukavice
HU Védőkesztyű
RO Mănuși de lucru

Kod EAN
5901477122392

Kod produktu **G73542** **300**

Rękawice ochronne GEKO r.9/białe/

rozmiar/size **10**



Opakowanie **12** par

GB Working gloves
DE Arbeitshandschuh
RU Рабочие перчатки
CZ Pracovní rukavice
SK Pracovné rukavice
HU Védőkesztyű
RO Mănuși de lucru

Kod EAN
5901477122408

Kod produktu **G73543** **300**

Rękawice ochronne GEKO r.10/białe/

rozmiar/size **9**



Opakowanie **12** par

GB Working gloves
DE Arbeitshandschuh
RU Рабочие перчатки
CZ Pracovní rukavice
SK Pracovné rukavice
HU Védőkesztyű
RO Mănuși de lucru

Kod EAN
5901477122415

Kod produktu **G73552** **300**

Rękawice ochronne GEKO r.9/żółte/

rozmiar/size **10**



Opakowanie **12** par

GB Working gloves
DE Arbeitshandschuh
RU Рабочие перчатки
CZ Pracovní rukavice
SK Pracovné rukavice
HU Védőkesztyű
RO Mănuși de lucru

Kod EAN
5901477122422

Kod produktu **G73553** **300**

Rękawice ochronne GEKO r.10/żółte/

rozmiar/size **9**



Opakowanie **12** par

GB Working gloves
DE Arbeitshandschuh
RU Рабочие перчатки
CZ Pracovní rukavice
SK Pracovné rukavice
HU Védőkesztyű
RO Mănuși de lucru

Kod EAN
5901477122453

Kod produktu **G73572 240**

Rękawice ochronne GEKON r.9/latex,czarne grube/

rozmiar/size **10**



Opakowanie **12** par

GB Working gloves
DE Arbeitshandschuh
RU Рабочие перчатки
CZ Pracovní rukavice
SK Pracovné rukavice
HU Védőkesztyű
RO Mănuși de lucru

Kod EAN
5901477122460

Kod produktu **G73573 240**

Rękawice ochronne GEKON r.10/latex,czarne grube/

rozmiar/size **8**



Opakowanie **12** par

GB Working gloves
DE Arbeitshandschuh
RU Рабочие перчатки
CZ Pracovní rukavice
SK Pracovné rukavice
HU Védőkesztyű
RO Mănuși de lucru

Kod EAN
5901477147180

Kod produktu **G73585 480**

Rękawice robocze ocieplane zimowe GREEN r.8

rozmiar/size **9**



Opakowanie **12** par

GB Working gloves
DE Arbeitshandschuh
RU Рабочие перчатки
CZ Pracovní rukavice
SK Pracovné rukavice
HU Védőkesztyű
RO Mănuși de lucru

Kod EAN
5901477147197

Kod produktu **G73586 480**

Rękawice robocze ocieplane zimowe GREEN r.9

rozmiar/size **10**



Opakowanie **12** par

GB Working gloves
DE Arbeitshandschuh
RU Рабочие перчатки
CZ Pracovní rukavice
SK Pracovné rukavice
HU Védőkesztyű
RO Mănuși de lucru

Kod EAN
5901477147173

Kod produktu **G73587 480**

Rękawice robocze ocieplane zimowe GREEN r.10

rozmiar/size **8**



Opakowanie **12** par

GB Working gloves
DE Arbeitshandschuh
RU Рабочие перчатки
CZ Pracovní rukavice
SK Pracovné rukavice
HU Védőkesztyű
RO Mănuși de lucru

Kod EAN
5901477147210

Kod produktu **G73590 480**

Rękawice robocze ocieplane zimowe ORANGE r.8

rozmiar/size **9**



Opakowanie **12** par

GB Working gloves
DE Arbeitshandschuh
RU Рабочие перчатки
CZ Pracovní rukavice
SK Pracovné rukavice
HU Védőkesztyű
RO Mănuși de lucru

Kod EAN
5901477147227

Kod produktu **G73591 480**

Rękawice robocze ocieplane zimowe ORANGE r.9

rozmiar/size **10**



Opakowanie **12** par

GB Working gloves
DE Arbeitshandschuh
RU Рабочие перчатки
CZ Pracovní rukavice
SK Pracovné rukavice
HU Védőkesztyű
RO Mănuși de lucru

Kod EAN
5901477147203

Kod produktu **G73592 480**

Rękawice robocze ocieplane zimowe ORANGE r.10

rozmiar/size **8**



Opakowanie **12** par

GB Working gloves
DE Arbeitshandschuh
RU Рабочие перчатки
CZ Pracovní rukavice
SK Pracovné rukavice
HU Védőkesztyű
RO Mănuși de lucru

Kod EAN
5901477147159

Kod produktu **G73595 240**

Rękawice robocze ocieplane zimowe BLUE r.8

rozmiar/size **9**



Opakowanie **12** par

GB Working gloves
DE Arbeitshandschuh
RU Рабочие перчатки
CZ Pracovní rukavice
SK Pracovné rukavice
HU Védőkesztyű
RO Mănuși de lucru

Kod EAN
5901477147166

Kod produktu **G73596 240**

Rękawice robocze ocieplane zimowe BLUE r.9

rozmiar/size **10**



Opakowanie **12** par

GB Working gloves
DE Arbeitshandschuh
RU Рабочие перчатки
CZ Pracovní rukavice
SK Pracovné rukavice
HU Védőkesztyű
RO Mănuși de lucru

Kod EAN
5901477147142

Kod produktu **G73597 240**

Rękawice robocze ocieplane zimowe BLUE r.10



Opakowanie **100** par

GB Garden gloves
DE Gartenhandschuhe
RU Садовые перчатки
CZ Zahradnické rukavice
SK Záhradnicke rukavice
HU Kertészkesztyűk
RO Mănuși de grădinărit

Kod EAN
5901477134487

Kod produktu **G73599 100**

Rękawice ogrodowe z pazurkami

rozmiar/size **8**



GB Working gloves
DE Arbeitshandschuh
RU Рабочие перчатки
CZ Pracovní rukavice
SK Pracovné rukavice
HU Védőkesztyű
RO Mănuși de lucru

Opakowanie **12** par

Kod EAN
5901477178689

Kod produktu **G75000 120**

Rękawice robocze ocieplane zimowe fluorescencyjne

rozmiar/size **9**



GB Working gloves
DE Arbeitshandschuh
RU Рабочие перчатки
CZ Pracovní rukavice
SK Pracovné rukavice
HU Védőkesztyű
RO Mănuși de lucru

Opakowanie **12** par

Kod EAN
5901477178696

Kod produktu **G75001 120**

Rękawice robocze ocieplane zimowe fluorescencyjne

rozmiar/size **10**



GB Working gloves
DE Arbeitshandschuh
RU Рабочие перчатки
CZ Pracovní rukavice
SK Pracovné rukavice
HU Védőkesztyű
RO Mănuși de lucru

Opakowanie **12** par

Kod EAN
5901477178641

Kod produktu **G75002 120**

Rękawice robocze ocieplane zimowe fluorescencyjne

rozmiar/size **11**



GB Working gloves
DE Arbeitshandschuh
RU Рабочие перчатки
CZ Pracovní rukavice
SK Pracovné rukavice
HU Védőkesztyű
RO Mănuși de lucru

Opakowanie **12** par

Kod EAN
5901477178658

Kod produktu **G75003 120**

Rękawice robocze ocieplane zimowe fluorescencyjne

rozmiar/size **7**



GB Working gloves
DE Arbeitshandschuh
RU Рабочие перчатки
CZ Pracovní rukavice
SK Pracovné rukavice
HU Védőkesztyű
RO Mănuși de lucru

Opakowanie **12** par

Kod EAN
5901477179143

Kod produktu **G75010 240**

Rękawice ochronne powlekane – różowe

rozmiar/size **8**



GB Working gloves
DE Arbeitshandschuh
RU Рабочие перчатки
CZ Pracovní rukavice
SK Pracovné rukavice
HU Védőkesztyű
RO Mănuși de lucru

Opakowanie **12** par

Kod EAN
5901477179150

Kod produktu **G75011 240**

Rękawice ochronne powlekane – żółte

rozmiar/size **9**



GB Working gloves
DE Arbeitshandschuh
RU Рабочие перчатки
CZ Pracovní rukavice
SK Pracovné rukavice
HU Védőkesztyű
RO Mănuși de lucru

Opakowanie **12** par

Kod EAN
5901477179167

Kod produktu **G75012 240**

Rękawice ochronne powlekane – pomarańczowe

rozmiar/size **10**



GB Working gloves
DE Arbeitshandschuh
RU Рабочие перчатки
CZ Pracovní rukavice
SK Pracovné rukavice
HU Védőkesztyű
RO Mănuși de lucru

Opakowanie **12** par

Kod EAN
5901477179174

Kod produktu **G75013 240**

Rękawice ochronne powlekane – fioletowe

rozmiar/size **11**



GB Working gloves
DE Arbeitshandschuh
RU Рабочие перчатки
CZ Pracovní rukavice
SK Pracovné rukavice
HU Védőkesztyű
RO Mănuși de lucru

Opakowanie **12** par

Kod EAN
5901477179181

Kod produktu **G75014 240**

Rękawice ochronne powlekane – niebieskie

rozmiar/size **12**



GB Working gloves
DE Arbeitshandschuh
RU Рабочие перчатки
CZ Pracovní rukavice
SK Pracovné rukavice
HU Védőkesztyű
RO Mănuși de lucru

Opakowanie **12** par

Kod EAN
5901477179198

Kod produktu **G75015 240**

Rękawice ochronne powlekane – granatowe

rozmiar/size **8**



GB Working gloves
DE Arbeitshandschuh
RU Рабочие перчатки
CZ Pracovní rukavice
SK Pracovné rukavice
HU Védőkesztyű
RO Mănuși de lucru

Opakowanie **12** par

Kod EAN
5901477178580

Kod produktu **G75021 240**

Rękawice robocze nylonowe

rozmiar/size **9**



GB Working gloves
DE Arbeitshandschuh
RU Рабочие перчатки
CZ Pracovní rukavice
SK Pracovné rukavice
HU Védőkesztyű
RO Mănuși de lucru

Opakowanie **12** par

Kod EAN
5901477179532

Kod produktu **G75022 240**

Rękawice robocze nylonowe

rozmiar/size
10



Opakowanie
12 par

GB Working gloves
DE Arbeitshandschuh
RU Рабочие перчатки
CZ Pracovní rukavice
SK Pracovné rukavice
HU Védőkesztyű
RO Mănuși de lucru



Kod EAN
5901477179549
Kod produktu
G75023 240

Rękawice robocze nylonowe

rozmiar/size
11



Opakowanie
12 par

GB Working gloves
DE Arbeitshandschuh
RU Рабочие перчатки
CZ Pracovní rukavice
SK Pracovné rukavice
HU Védőkesztyű
RO Mănuși de lucru



Kod EAN
5901477179556
Kod produktu
G75024 240

Rękawice robocze nylonowe

rozmiar/size
8



Opakowanie
12 par

GB Working gloves
DE Arbeitshandschuh
RU Рабочие перчатки
CZ Pracovní rukavice
SK Pracovné rukavice
HU Védőkesztyű
RO Mănuși de lucru



Kod EAN
5901477191169
Kod produktu
G75035 120

Rękawice robocze wodoodporne ocieplane /jersey – lateks/

rozmiar/size
9



Opakowanie
12 par

GB Working gloves
DE Arbeitshandschuh
RU Рабочие перчатки
CZ Pracovní rukavice
SK Pracovné rukavice
HU Védőkesztyű
RO Mănuși de lucru



Kod EAN
5901477191213
Kod produktu
G75043 120

Rękawice robocze wodoodporne ocieplane zimowe /bawełna-lateks/

rozmiar/size
11



Opakowanie
12 par

GB Working gloves
DE Arbeitshandschuh
RU Рабочие перчатки
CZ Pracovní rukavice
SK Pracovné rukavice
HU Védőkesztyű
RO Mănuși de lucru



Kod EAN
5901477191152
Kod produktu
G75031 120

Rękawice robocze wodoodporne /poliester – lateks/



Opakowanie
50 sztuk



GB Nitrile gloves
DE Handschuhe aus Nitril
RU Нитриловые перчатки
CZ Nitrilové rukavice
SK Nitrilové rukavice
HU Nitril kesztyű
RO Mănuși de nitril

Kod produktu		
Rękawice nitrylowe SOLID GRIP 50szt. r. S czarne	G75200-S	10
Rękawice nitrylowe SOLID GRIP 50szt. r. M czarne	G75200-M	10
Rękawice nitrylowe SOLID GRIP 50szt. r. L czarne	G75200-L	10
Rękawice nitrylowe SOLID GRIP 50szt. r. XL czarne	G75200-XL	10
Rękawice nitrylowe SOLID GRIP 50szt. r. XXL czarne	G75200-XXL	10

Opakowanie
50 sztuk



GB Nitrile gloves
DE Handschuhe aus Nitril
RU Нитриловые перчатки
CZ Nitrilové rukavice
SK Nitrilové rukavice
HU Nitril kesztyű
RO Mănuși de nitril

Kod produktu		
Rękawice nitrylowe SOLID GRIP 50szt. r. S pomarańczowe	G75201-S	10
Rękawice nitrylowe SOLID GRIP 50szt. r. M pomarańczowe	G75201-M	10
Rękawice nitrylowe SOLID GRIP 50szt. r. L pomarańczowe	G75201-L	10
Rękawice nitrylowe SOLID GRIP 50szt. r. XL pomarańczowe	G75201-XL	10
Rękawice nitrylowe SOLID GRIP 50szt. r. XXL pomarańczowe	G75201-XXL	10

Wałki przekaźnika mocy / PTO Shafts



rura-T

80
cm

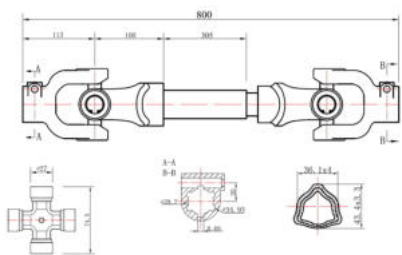

GB PTO shaft lemon tube
DE Gelenkwelle Zapfwelle
RU Шарнирно-телескопические валы
CZ Kloubova hřídel
SK Kľbový hriadel
HU Öntözöpisztoly
RO Vand Arbore cardanic cu dlichet



Kod EAN

5901477126932

Walek przekaźnika mocy 80cm (rura-T) **G72300** **1**

rura-T

100
cm

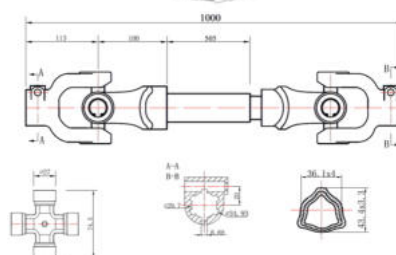

GB PTO shaft lemon tube
DE Gelenkwelle Zapfwelle
RU Шарнирно-телескопические валы
CZ Kloubova hřídel
SK Kľbový hriadel
HU Öntözöpisztoly
RO Vand Arbore cardanic cu dlichet



Kod EAN

5901477123832

Walek przekaźnika mocy 100cm (rura-T) **G72301** **1**

rura-T

120
cm

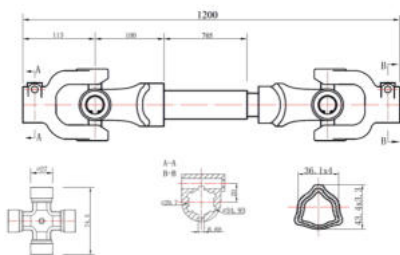

GB PTO shaft lemon tube
DE Gelenkwelle Zapfwelle
RU Шарнирно-телескопические валы
CZ Kloubova hřídel
SK Kľbový hriadel
HU Öntözöpisztoly
RO Vand Arbore cardanic cu dlichet



Kod EAN

5901477126710

Walek przekaźnika mocy 120cm (rura-T) **G72302** **1**

rura-T

75
cm



GB PTO shaft lemon tube
DE Gelenkwelle Zapfwelle
RU Шарнирно-телескопические валы
CZ Kloubova hřídel
SK Kľbový hriadel
HU Öntözöpisztoly
RO Vand Arbore cardanic cu dlichet



Kod EAN

5901477123818

Walek przekaźnika mocy 75cm (rura-T) **G72303** **1**

rura-T
90
cm

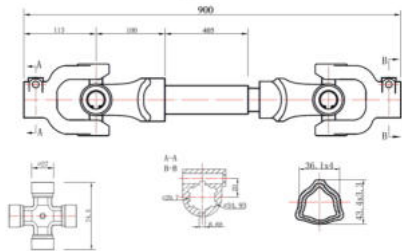

GB PTO shaft lemon tube
DE Gelenkwelle Zapfwelle
RU Шарнирно-телескопические валы
CZ Kloubova hřídel
SK Kľbový hriadel
HU Öntözöpisztoly
RO Vand Arbore cardanic cu dichtet



Kod EAN
5901477123825

Walek przekaźnika mocy 90cm (rura-T) Kod produktu **G72304** 1

rura-T
110
cm

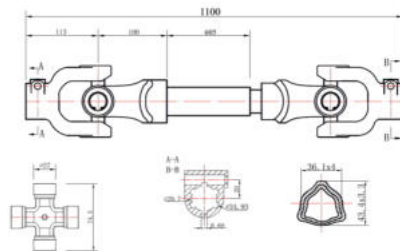

GB PTO shaft lemon tube
DE Gelenkwelle Zapfwelle
RU Шарнирно-телескопические валы
CZ Kloubova hřídel
SK Kľbový hriadel
HU Öntözöpisztoly
RO Vand Arbore cardanic cu dichtet



Kod EAN
5901477123849

Walek przekaźnika mocy 110cm (rura-T) Kod produktu **G72305** 1

frez
80
cm

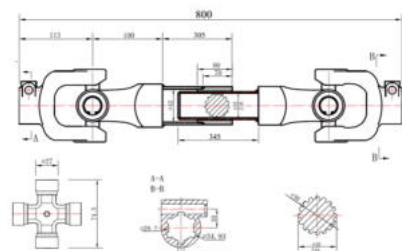

GB PTO shaft lemon tube
DE Gelenkwelle Zapfwelle
RU Шарнирно-телескопические валы
CZ Kloubova hřídel
SK Kľbový hriadel
HU Öntözöpisztoly
RO Vand Arbore cardanic cu dichtet



Kod EAN
5901477123757

Walek przekaźnika mocy 80cm (frez) Kod produktu **G72310** 1

frez
100
cm

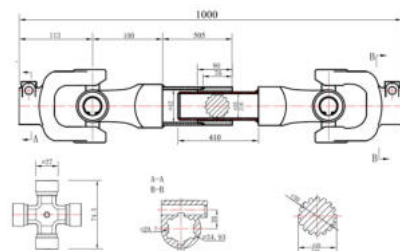

GB PTO shaft lemon tube
DE Gelenkwelle Zapfwelle
RU Шарнирно-телескопические валы
CZ Kloubova hřídel
SK Kľbový hriadel
HU Öntözöpisztoly
RO Vand Arbore cardanic cu dichtet



Kod EAN
5901477123764

Walek przekaźnika mocy 100cm (frez) Kod produktu **G72311** 1

frez
120
cm

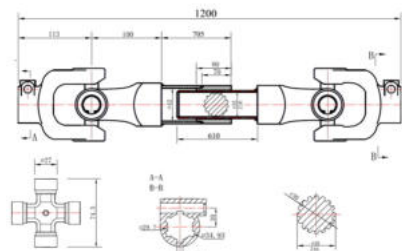

GB PTO shaft lemon tube
DE Gelenkwelle Zapfwelle
RU Шарнирно-телескопические валы
CZ Kloubova hřídel
SK Kľbový hriadel
HU Öntözöpisztoly
RO Vand Arbore cardanic cu dichtet



Kod EAN
5901477123771

Walek przekaźnika mocy 120cm (frez) Kod produktu **G72312** 1

frez
75
cm

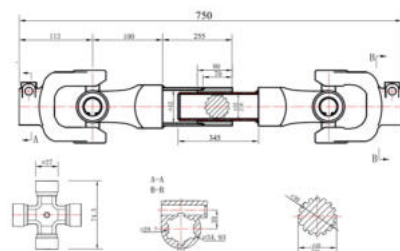

GB PTO shaft lemon tube
DE Gelenkwelle Zapfwelle
RU Шарнирно-телескопические валы
CZ Kloubova hřídel
SK Kľbový hriadel
HU Öntözöpisztoly
RO Vand Arbore cardanic cu dichtet



Kod EAN
5901477123740

Walek przekaźnika mocy 75cm (frez) Kod produktu **G72313** 1

3.00/4.00
2PR
2.1bar
136kg



GB Rubber wheels
DE Räder
RU Koneca
CZ Gumové kolo
SK Gumové koleso
HU Kerék
RO Roată din cauciuc



Koło do wózka 3.00-4/2PR G71014 10

4.00/8.00
8PR
3.4bar
180kg



GB Rubber wheels
DE Räder
RU Koneca
CZ Gumové kolo
SK Gumové koleso
HU Kerék
RO Roată din cauciuc



Koło do taczki 4.00-8/ opona 8PR (szare) G71017 1

4.00/8.00
6PR
2.1bar
250kg



GB Rubber wheels
DE Räder
RU Koneca
CZ Gumové kolo
SK Gumové koleso
HU Kerék
RO Roată din cauciuc



Koło do taczki 4.00-8 6PR/niebieska felga/ G71019 1

4.00/8.00
4PR
2.1bar



GB Rubber wheels
DE Räder
RU Koneca
CZ Gumové kolo
SK Gumové koleso
HU Kerék
RO Roată din cauciuc



Koło do taczki 4.00-8 4PR/bieżnik romb,f.zielona/ G71022 1

3.50/4.00
PU



GB Rubber wheels
DE Räder
RU Koneca
CZ Gumové kolo
SK Gumové koleso
HU Kerék
RO Roată din cauciuc



Koło do taczki 4.00-8 pełne Flower/żółte G71023 5

4.00/8.00
PU



GB Rubber wheels
DE Räder
RU Koneca
CZ Gumové kolo
SK Gumové koleso
HU Kerék
RO Roată din cauciuc



Koło do taczki 4.00-8 pełne PU orange/ G71024 5

3.00/4.00
PU



GB Rubber wheels
DE Räder
RU Koneca
CZ Gumové kolo
SK Gumové koleso
HU Kerék
RO Roată din cauciuc



Koło do wózka 3.00-4 PU/pełne/ G71025 10

3.50/4.00
PU



GB Rubber wheels
DE Räder
RU Koneca
CZ Gumové kolo
SK Gumové koleso
HU Kerék
RO Roată din cauciuc



Koło do wózka 3.50-4 PU/pełne/ G71026 10

4.00/6.00
PU



GB Rubber wheels
DE Räder
RU Koneca
CZ Gumové kolo
SK Gumové koleso
HU Kerék
RO Roată din cauciuc



Koło do taczki 4.00-6 pełne PU G71027 10

3.50/8.00
PU



GB Rubber wheels
DE Räder
RU Koneca
CZ Gumové kolo
SK Gumové koleso
HU Kerék
RO Roată din cauciuc



Koło do taczki 3.50-8 pełne PU Flower G71028 5

3.50/8.00
2PR
2.4bar



GB Rubber wheels
DE Räder
RU Koneca
CZ Gumové kolo
SK Gumové koleso
HU Kerék
RO Roată din cauciuc



Koło do taczki 3.50-8/2PR G71040 1

3.25/8.00
2PR
1.7bar



GB Rubber wheels
DE Räder
RU Koneca
CZ Gumové kolo
SK Gumové koleso
HU Kerék
RO Roată din cauciuc



Koło do taczki 3.25-8/2PR G71041 5

4.00/8.6
2PR

2bar



GB Rubber wheels
DE Räder
RU Колеса
CZ Gumové kolo
SK Gumové koleso
HU Kerék
RO Roată din cauciuc

Kod EAN
5903418300470

Kod produktu
G71029 1

Koło do taczki 4.00-8 6PR fi 20mm (bez ośki)

3.50/4.00
4PR

2.07bar



GB Rubber wheels
DE Räder
RU Колеса
CZ Gumové kolo
SK Gumové koleso
HU Kerék
RO Roată din cauciuc

Kod EAN
5901477158087

Kod produktu
G71046 10

Koło do wózka 3.50-4 20mm - dł.piastry 70mm (G7102)

4.00/10
4PR

350kg



GB Rubber wheels
DE Räder
RU Колеса
CZ Gumové kolo
SK Gumové koleso
HU Kerék
RO Roată din cauciuc

Kod EAN
5901477158124

Kod produktu
G71047 1

Koło pneumatyczne z dętką do zgrabiarki 4.00-10

4.00/10
4PR

350kg





GB Rubber wheels
DE Räder
RU Колеса
CZ Gumové kolo
SK Gumové koleso
HU Kerék
RO Roată din cauciuc

Kod EAN
5901477158131

Kod produktu
G71048 1

Koło pneumatyczne z dętką do zgrabiarki 4.00-10 z piastą

4.00/8.00
TYP A

GB Bearings
DE die Radlager
RU Подшипники колес
CZ Ložiska
SK Ložiská
HU Kerékcsapágy
RO Rulmenti

Kod EAN
5901477120244

Kod produktu
G71010 500

Łożysko do kół 4.00-8 TYP A

4.00/8.00
2PR



GB Tyres, inner tubes
DE Reifen, Schläuchen
RU Шины, камеры
CZ Pneumatiky, duše
SK Pneumatiky, duše
HU Gumiabroncsok
RO Anvelope

Kod EAN
5901477113659

Kod produktu
G71000 20

Opona z dętką 4.80/4.00-8 2PR

4.00/6.00
2PR



GB Tyres, inner tubes
DE Reifen, Schläuchen
RU Шины, камеры
CZ Pneumatiky, duše
SK Pneumatiky, duše
HU Gumiabroncsok
RO Anvelope

Kod EAN
5901477115172

Kod produktu
G71009 20

Opona z dętką 4.00-6/2PR

4.00/8.00
6PR



GB Tyres, inner tubes
DE Reifen, Schläuchen
RU Шины, камеры
CZ Pneumatiky, duše
SK Pneumatiky, duše
HU Gumiabroncsok
RO Anvelope

Kod EAN
5901477129902

Kod produktu
G71018 20

Opona z dętką 4.00-8/6PR

4.00/8.00
4PR



GB Tyres, inner tubes
DE Reifen, Schläuchen
RU Шины, камеры
CZ Pneumatiky, duše
SK Pneumatiky, duše
HU Gumiabroncsok
RO Anvelope

Kod EAN
5901477120299

Kod produktu
G71020 20

Opona z dętką 4.00-8/4PR romb

3.00/4.00
2PR



GB Tyres, inner tubes
DE Reifen, Schläuchen
RU Шины, камеры
CZ Pneumatiky, duše
SK Pneumatiky, duše
HU Gumiabroncsok
RO Anvelope

Kod EAN
5901477126222

Kod produktu
G71030 20

Opona z dętką 3.00-4/2PR

3.50/4.00
2PR



GB Tyres, inner tubes
DE Reifen, Schläuchen
RU Шины, камеры
CZ Pneumatiky, duše
SK Pneumatiky, duše
HU Gumiabroncsok
RO Anvelope

Kod EAN
5901477143335

Kod produktu
G71031 15

Opona z dętką 3.50-4/2PR

4.00/4.00
2PR



GB Tyres, inner tubes
DE Reifen, Schläuchen
RU Шины, камеры
CZ Pneumatiky, duše
SK Pneumatiky, duše
HU Gumiabroncsok
RO Anvelope

Kod EAN
5901477126239

Kod produktu
G71032 20

Opona z dętką 4.00-4/2PR

3.25/8.00
2PR



GB Tyres, inner tubes
DE Reifen, Schläuchen
RU Шины, камеры
CZ Pneumatiky, duše
SK Pneumatiky, duše
HU Gumiabroncsok
RO Anvelope

Kod EAN
5901477134302

Kod produktu
G71042 20

Opona z dętką 3.25-8 2PR

3.50/8.00
2PR



GB Tyres, inner tubes
DE Reifen, Schläuchen
RU Шины, камеры
CZ Pneumatiky, duše
SK Pneumatiky, duše
HU Gumiabroncsok
RO Anvelope

Kod EAN
5901477134319

Kod produktu
G71043 20

Opona z dętką 3.50-8 2PR

4.00/8.00
2PR



GB Tyres, inner tubes
DE Reifen, Schläuchen
RU Шины, камеры
CZ Pneumatiky, duše
SK Pneumatiky, duše
HU Gumiabroncsok
RO Anvelope

Kod EAN
5901477126703

Kod produktu
G71035 20

Opona do taczki 4.00-8 2PR

4.00/8.00
4PR



GB Tyres, inner tubes
DE Reifen, Schläuchen
RU Шины, камеры
CZ Pneumatiky, duše
SK Pneumatiky, duše
HU Gumiabroncsok
RO Anvelope

Kod EAN
5901477126727

Kod produktu
G71036 20

Opona do taczki 4.00-8 4PR

4.00/8.00



GB Tyres, inner tubes
DE Reifen, Schläuchen
RU Шины, камеры
CZ Pneumatiky, duše
SK Pneumatiky, duše
HU Gumiabroncsok
RO Anvelope

Kod EAN
5901477120220

Kod produktu
G71007 50

Dętka 4.00-8

3.00-4



GB Tyres, inner tubes
DE Reifen, Schläuchen
RU Шины, камеры
CZ Pneumatiky, duše
SK Pneumatiky, duše
HU Gumiabroncsok
RO Anvelope

Kod EAN
5901477120237

Kod produktu
G71008 100

Dętka 3 - 4

4.00-6



GB Tyres, inner tubes
DE Reifen, Schläuchen
RU Шины, камеры
CZ Pneumatiky, duše
SK Pneumatiky, duše
HU Gumiabroncsok
RO Anvelope

Kod EAN
5901477120275

Kod produktu
G71015 50

Dętka 4.00-6

3.25-8



GB Tyres, inner tubes
DE Reifen, Schläuchen
RU Шины, камеры
CZ Pneumatiky, duše
SK Pneumatiky, duše
HU Gumiabroncsok
RO Anvelope

Kod EAN
5901477161902

Kod produktu
G71033 1

Dętka 3.25-8



3.50-8



GB Tyres, inner tubes
DE Reifen, Schläuchen
RU Шины, камеры
CZ Pneumatiky, duše
SK Pneumatiky, duše
HU Gumiabroncsok
RO Anvelope

Kod EAN
5901477161919

Kod produktu
G71034 1

Dętka 3.50-8

4.00-4 80kg



GB Rubber wheels
DE Räder
RU Колеса
CZ Gumové kolo
SK Gumové koleso
HU Kerék
RO Roată din cauciuc

Kod EAN
5901477191442

Kod produktu
G71049 10

Koło pełne gładkie 4.00-4 do owijarki belarki

Silniki elektryczne / Electric Engines



GB Electric engine
 DE Elektromotor
 RU Электрический двигатель
 CZ Elektrický motor
 SK Elektrický motor
 HU Elektromos motor
 RO Motoare electrice



5901477150913

Kod produktu

Silnik elektryczny 1.5KW/2KM 230V 1 fazowy G80360 1

GB Electric engine
 DE Elektromotor
 RU Электрический двигатель
 CZ Elektrický motor
 SK Elektrický motor
 HU Elektromos motor
 RO Motoare electrice



5901477150920

Kod produktu

Silnik elektryczny 2.2KW/3KM 230V 1 fazowy G80361 1



GB Electric engine
 DE Elektromotor
 RU Электрический двигатель
 CZ Elektrický motor
 SK Elektrický motor
 HU Elektromos motor
 RO Motoare electrice



5901477150937

Kod produktu

#Silnik elektryczny 3KW/4KM 230V 1 fazowy G80362 1



5901477166396



5901477166389



5901477166372

GB Pulley wheel
 DE Riemenscheibe
 RU Шкив колеса
 CZ Kladkové kolo
 SK Kladkové koleso
 HU Szíjtárcsa kerék
 RO Roata scripete

Kod produktu

Koło pasowe do silnika elektrycznego 1,5KW/2KM CG80360A 1
Koło pasowe do silnika elektrycznego 2,2KW/3KM CG80361A 1
Koło pasowe do silnika elektrycznego 3KW/4KM CG80362A 1

Silniki spalinowe / Gas Engines



389cc
13KM

3600obr/min



196cc
7KM

3600obr/min



GB Gasoline four-stroke engine
DE 4-Takt-Verbrennungsmotor
RU Бензин четырехтактный двигатель
CZ Benzínový motor čtyřtákní
SK Benzínový motor štvortákný
HU Vízszintes tengelyű motor
RO Motor pe benzina

GB Gasoline four-stroke engine
DE 4-Takt-Verbrennungsmotor
RU Бензин четырехтактный двигатель
CZ Benzínový motor čtyřtákní
SK Benzínový motor štvortákný
HU Vízszintes tengelyű motor
RO Motor pe benzina

Kod EAN
5901477177088

Kod EAN
5901477129070

Silnik spalinowy 13HP Loncin G390F 25mm (rozruch manualny) G80249 1

Silnik spalinowy czterosuwowy 7KM G80250 1

389cc 13KM

3600obr/min



GB Gasoline four-stroke engine
DE 4-Takt-Verbrennungsmotor
RU Бензин четырехтактный двигатель
CZ Benzinový motor čtyřtákní
SK Benzinový motor štvortákný
HU Vízszintes tengelyű motor
RO Motor pe benzina

Kod EAN
5901477129087

Kod produktu 1
#Silnik spalinowy czterosuwowy 13KM G80251



196cc 6.5KM

3600obr/min



GB Gasoline four-stroke engine
DE 4-Takt-Verbrennungsmotor
RU Бензин четырехтактный двигатель
CZ Benzinový motor čtyřtákní
SK Benzinový motor štvortákný
HU Vízszintes tengelyű motor
RO Motor pe benzina

Kod EAN
5901477153402

Kod produktu 1
Silnik spalinowy 6.5HP czujnik oleju G80252



196cc 6.5KM

3600obr/min



GB Gasoline four-stroke engine
DE 4-Takt-Verbrennungsmotor
RU Бензин четырехтактный двигатель
CZ Benzinový motor čtyřtákní
SK Benzinový motor štvortákný
HU Vízszintes tengelyű motor
RO Motor pe benzina

Kod EAN
5901477154218

Kod produktu 1
Silnik spalinowy 6,5HP Loncin 196cc 19mm EURO 5 G80253



196cc 6.5KM

3600obr/min



GB Gasoline four-stroke engine
DE 4-Takt-Verbrennungsmotor
RU Бензин четырехтактный двигатель
CZ Benzinový motor čtyřtákní
SK Benzinový motor štvortákný
HU Vízszintes tengelyű motor
RO Motor pe benzina

Kod EAN
5901477177071

Kod produktu 1
Silnik spalinowy 6,5HP Loncin 196cc 20mm EURO 5 G80254



Oleje / oils



100ml



GB Two-stroke oil
DE Zweitaktöl
RU Масло для двухтактных двигателей
CZ Dvoutaktní olej
SK Dvojťaktný olej
HU Kétütemű motorolaj
RO Ulei de amestec pentru motoare în 2 timpi

Kod EAN
5901477121777

Kod produktu
G82010 24

Olej do silników dwusuwowych czerwony 100ml

1L



GB Two-stroke oil
DE Zweitaktöl
RU Масло для двухтактных двигателей
CZ Dvoutaktní olej
SK Dvojťaktný olej
HU Kétütemű motorolaj
RO Ulei de amestec pentru motoare în 2 timpi

Kod EAN
5901477121760

Kod produktu
G82011 12

Olej do silników dwusuwowych czerwony 1L

100ml



GB Two-stroke oil
DE Zweitaktöl
RU Масло для двухтактных двигателей
CZ Dvoutaktní olej
SK Dvojťaktný olej
HU Kétütemű motorolaj
RO Ulei de amestec pentru motoare în 2 timpi

Kod EAN
5901477171758

Kod produktu
G82012 24

Olej do silników dwusuwowych zielony 100ml

5L



GB Oil for chain bars and chains
DE Öl für Führungsschiene und Ketten
RU Масло для цепи и цепи
CZ Olej na mazání řetězů
SK Olej na mazanie reťazi
HU Láncenkő olaj
RO Ulei de lanț

Kod EAN
5901477127625

Kod produktu
G82016 4

Olej do smarowania prowadnic i łańcuchów GEKO 5L

1L



GB Oil for chain bars and chains
DE Öl für Führungsschiene und Ketten
RU Масло для цепи и цепи
CZ Olej na mazání řetězů
SK Olej na mazanie reťazi
HU Láncenkő olaj
RO Ulei de lanț

Kod EAN
5901477127618

Kod produktu
G82015 12

Olej do smarowania prowadnic i łańcuchów GEKO 1L

600ml



GB Oil for four-stroke engines
DE Öl für Viertaktmotoren
RU Масло для четырехтактных двигателей
CZ Olej pro čtyřtákní motory
SK Olej pre štvortaktné motory
HU Motorolaj 4 ütemű
RO Ulei pentru motoare in 4 timpi

Kod EAN
5901477160721

Kod produktu
G82024 16

Olej do silników czterosuwowych GEKO 0,6L

1L



GB Oil for four-stroke engines
DE Öl für Viertaktmotoren
RU Масло для четырехтактных двигателей
CZ Olej pro čtyřtákní motory
SK Olej pre štvortaktné motory
HU Motorolaj 4 ütemű
RO Ulei pentru motoare in 4 timpi

Kod EAN
5901477127656

Kod produktu
G82025 15

Olej do silników czterosuwowych GEKO 1L

Kanistry / Petrol Cans



5L Steel



GB Canister
DE Kanister
RU Канистра
CZ Kanistr
SK Kanister
HU Marmonkanna
RO Canistră



5901477146565

Kanister metalowy blaszany 5L G03230 8

10L Steel



GB Canister
DE Kanister
RU Канистра
CZ Kanistr
SK Kanister
HU Marmonkanna
RO Canistră



5901477146541

Kanister metalowy blaszany 10L G03231 5

20L Steel



GB Canister
DE Kanister
RU Канистра
CZ Kanistr
SK Kanister
HU Marmonkanna
RO Canistră



5901477146558

Kanister metalowy blaszany 20L G03232 4

Steel



GB Funnel
DE Trichter
RU Воронка гибкая
CZ Nálévka
SK Lievik
HU Kétrészes tölcser
RO Pálnie



5901477147555

Lejek metalowy do kanistra G03233 50

10L Alu



GB Canister
DE Kanister
RU Канистра
CZ Kanistr
SK Kanister
HU Marmonkanna
RO Canistră



Kod EAN
5901477173066

Kod produktu 3
Kanister aluminiowy 10L G03236

10L Alu



GB Canister
DE Kanister
RU Канистра
CZ Kanistr
SK Kanister
HU Marmonkanna
RO Canistră



Kod EAN
5901477173073

Kod produktu 3
Kanister aluminiowy 20L G03237

5L PE-HD



GB Canister
DE Kanister
RU Канистра
CZ Kanistr
SK Kanister
HU Marmonkanna
RO Canistră



Kod EAN
5901477147586

Kod produktu 12
Kanister plastik 5L + lejek G03240

10L PE-HD



GB Canister
DE Kanister
RU Канистра
CZ Kanistr
SK Kanister
HU Marmonkanna
RO Canistră



Kod EAN
5901477147562

Kod produktu 5
Kanister plastik 10L + lejek G03241

20L PE-HD



GB Canister
DE Kanister
RU Канистра
CZ Kanistr
SK Kanister
HU Marmonkanna
RO Canistră



Kod EAN
5901477147579

Kod produktu 5
Kanister plastik 20L + lejek G03242

Plastic



GB Funnel
DE Trichter
RU Воронка гибкая
CZ Nálévka
SK Lievik
HU Kétrészes tölcsér
RO Pálnie



Kod EAN
5901477183911

Kod produktu 100
Lejek długi do paliwa 12.5x45.5cm G02153

Grille / Grills



11.6 kW
Ilość palników: 3 + 1
piezo



14.5 kW
Ilość palników: 4 + 1
piezo



GB Gas BBQ grill
DE Der Gasgrill
RU Газовый гриль
CZ Plynový gril
SK Plynový gril
HU Gázgrill
RO Grătarul cu gaz



5901477177149

#Grill gazowy 4 palniki (3+1) 11,6kW
Kod produktu G80515 1

GB Gas BBQ grill
DE Der Gasgrill
RU Газовый гриль
CZ Plynový gril
SK Plynový gril
HU Gázgrill
RO Grătarul cu gaz



5901477177156

#Grill gazowy 5 palników (4+1) 14,5kW
Kod produktu G80516 1

GB Grill cover
DE Grillabdeckung
RU Крышка гриля
CZ Kryt grilu
SK Kryt grilu
HU Grill fedél
RO Capac gratar



5901477177187

Pokrowiec na grill G80515
Kod produktu CG80515-0 10

GB Grill cover
DE Grillabdeckung
RU Крышка гриля
CZ Kryt grilu
SK Kryt grilu
HU Grill fedél
RO Capac gratar



5901477177217

Pokrowiec na grill G80516
Kod produktu CG80516-0 10

3szt.



GB Grill Aromatizers
DE Grill-Aromatisierer
RU Ароматизаторы для гриля
CZ Aroma do grilu
SK Arómatisézy na gril
HU Grillaromák
RO Aromatizatoare pentru grătar



5901477177200

Aromatyzery do grilla G80515 (zestaw 3 szt)
Kod produktu CG80515-4 15

4szt.



GB Grill Aromatizers
DE Grill-Aromatisierer
RU Ароматизаторы для гриля
CZ Aroma do grilu
SK Arómatisézy na gril
HU Grillaromák
RO Aromatizatoare pentru grătar



5901477177231

Aromatyzery do grilla G80516 (zestaw 4 szt)
Kod produktu CG80516-4 15

RUSZT CHROMOWANY
CHROME-PLATED GRATE

POJEMNIK NA POPIÓŁ
ASH CONTAINER

71x45cm



RUSZT CHROMOWANY
CHROME-PLATED GRATE

POKROWIEC
COVER

39 cm



GB Charcoal grill
DE Holzkohlegrill
RU Угольный гриль
CZ Gril na dřevěné uhlí
SK Gril na drevěné uhlie
HU Faszén grill
RO Grătar cu cărbune

Kod EAN
5901477187728

Grill węglowy typu becзка z pokrywą – ruszt 71x35cm G80514 1

GB Round charcoal grill with cover
DE Runder Holzkohlegrill mit Deckel
RU Круглый угольный гриль с крышкой
CZ Kulatý gril na dřevěné uhlí s krytem
SK Okrúhly gril na drevěné uhlie s krytom
HU Kerek faszéngrill fedővel
RO Grătar rotund cu cărbune cu capac

Kod EAN
5901477187773

Grill węglowy okrągły z pokrywą i pokrowcem – ruszt średnica 39cm G80512 1

RUSZT CHROMOWANY
CHROME-PLATED GRATE

REGULACJA WYSOKOŚCI RUSZTU
ADJUSTMENT GRATE HEIGHT

40x40cm



58cm

23cm



GB Charcoal grill with adjustable
DE Holzkohlegrill mit einstellbarer
RU Гриль с регулируемым углем
CZ Gril na dřevěné uhlí s možností nastavení
SK Gril na drevěné uhlie s nastaviteľným
HU Charcoal grill állítható
RO Grătar cu cărbune cu grătar reglabil

Kod EAN
5901477187766

Grill węglowy z pokrywą i regulacją rusztu – ruszt 40x40cm G80513 1

GB Garden fireplace
DE Gartenkamin
RU Садовый камин
CZ Zahradní krb
SK Záhradný krb
HU Kerti kandalló
RO Semineu de gradina

Kod EAN
5901477187421

Palenisko ogrodowe 58cm G80519 1

3w1

gąbka
druziak
skrobak
prosty



31cm

GB Barbecue grill brush
DE Barbecue-Grillbürste
RU Щетка для гриля для барбекю
CZ Kartáč na grilování
SK Kefa na grilovanie
HU Barbecue grill kefe
RO Perie pentru grătar

Kod EAN
5901477185441

Szczotka drucziana ze skrobakiem i gąbką 3w1 – do czyszczenia grilla G80509 50/60

GB Barbecue grill brush
DE Barbecue-Grillbürste
RU Щетка для гриля для барбекю
CZ Kartáč na grilování
SK Kefa na grilovanie
HU Barbecue grill kefe
RO Perie pentru grătar

Kod EAN
5901477185458

Szczotka drucziana 31x17cm – do czyszczenia grilla G80511 100

Pozostałe / Other Garden Tools

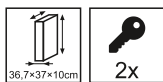

GB Mailbox
DE Briefkasten
RU Почтовый ящик
CZ Schránka na dopisy
SK Schránka na listy
HU Levélláda
RO Cutie poștală



Kod EAN
5903418300241

Skrzynka na listy 36,7x37x10cm /Antracyt **G10922** **5**

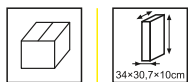

GB Mailbox
DE Briefkasten
RU Почтовый ящик
CZ Schránka na dopisy
SK Schránka na listy
HU Levélláda
RO Cutie poștală



Kod EAN
5903418300302

Skrzynka na listy 34x30,7x10cm /Czarna **G10923** **5**

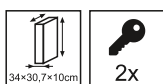

GB Mailbox
DE Briefkasten
RU Почтовый ящик
CZ Schránka na dopisy
SK Schránka na listy
HU Levélláda
RO Cutie poștală



Kod EAN
5903418300319

Skrzynka na listy 34x30,7x10cm /Szara **G10924** **5**

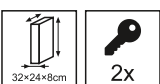

GB Mailbox
DE Briefkasten
RU Почтовый ящик
CZ Schránka na dopisy
SK Schránka na listy
HU Levélláda
RO Cutie poștală



Kod EAN
5901477160509

Skrzynka na listy 320x240x80mm **G10921** **10**

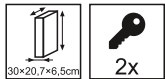

GB Mailbox
DE Briefkasten
RU Почтовый ящик
CZ Schránka na dopisy
SK Schránka na listy
HU Levélláda
RO Cutie poștală



Skrzynka na listy 300x207x65mm Kod produktu **G10920** **20**



4000 kg

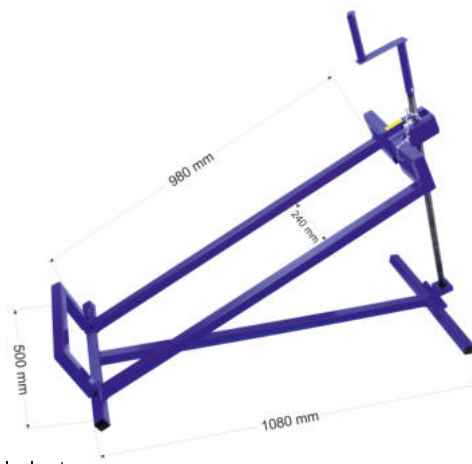

GB Motorcycle elevator
DE Motorradheberzeug
RU Мотоциклетный домкрат
CZ Stojan na motocykl, nosnost
SK Stojan na motocykel, nosnosť
HU Motorkerékprár alátámasztó
RO Elevatoare pentru Motociclete



Podnošnik ATV kosiarki, quada, traktorka Kod produktu **G02183** **1**



2mm x 20m



GB Hand-driven maize sheller
DE Hand bedient mais
RU Измельчитель кукурузы с ручным приводом
CZ Lupačka na kukurici
SK Lupačka na kukuricu
HU Kézi hajtású kukorica morzsoló
RO Batoza curatat porumb stiuleti manuala cu coarba



Łuszczarka do kukurydzy Kod produktu **G73187** **1**



GB Clothesline
DE Wäscheleine
RU Веревка для белья
CZ Šňůra na prádlo
SK Šňůra na prádlo
HU Ruhaszárító kötél
RO Coarda rufe



Linka stalowa do bielizny 2mm x 20m Kod produktu **G73190** **48**



3mm x 30m



GB Clothesline
DE Wäscheleine
RU Веревка для белья
CZ Šňůra na prádlo
SK Šňůra na prádlo
HU Ruhaszárító kötél
RO Coarda rufe



Linka stalowa do bielizny 3mm x 30m Kod produktu **G73191** **24**



GB 2in1 barbecue grill brush with scraper
DE 2in1 Grillbürste mit Schaber
RU Щетка для гриля 2 в 1 со скребком
CZ Kartáč na grilování 2v1 se škrabkou
SK Kefa na grilovanie 2v1 so škrabkou
HU Kefa na grilovanie 2v1 so škrabkou
RO 2az1-ben grillkefe kaparóval



Szczotka drucziana ze skrobakiem 2w1 – do czyszczenia grilla Kod produktu **G80508** **90**



GB Barbecue grill accessories set
DE Grillzubehör-Set
RU Набор аксессуаров для барбекю
CZ Sada příslušenství ke grilu
SK Sada príslušenstva na grilovanie
HU Sada príslušenstva na grilovanie
RO Set accesorii gratar gratar



Zestaw sztućców do grilla 10el. Kod produktu **G80510** **12**



GB Mini greenhouse
DE Mini-Gewächshaus
RU Мини теплица
CZ Mini skleník
SK Mini skleník
HU Mini üvegház
RO Mini sera



Mini szklarnia ogrodowa - balkonowa 5 półek Kod produktu **G73291** **1**



GB Garden greenhouse
DE Gartengewächshaus
RU Садовая теплица
CZ Zahradní skleník
SK Záhradný skleník
HU Kerti üvegház
RO Seră de grădină



5903418305765

Szklarnia – tunel foliowy ogrodowy 3x4x2m UV **G73295** **1**



GB Garden greenhouse
DE Gartengewächshaus
RU Садовая теплица
CZ Zahradní skleník
SK Záhradný skleník
HU Kerti üvegház
RO Seră de grădină



5903418305772

Szklarnia – tunel foliowy ogrodowy 3x6x2m UV **G73296** **1**



GB Garden greenhouse
DE Gartengewächshaus
RU Садовая теплица
CZ Zahradní skleník
SK Záhradný skleník
HU Kerti üvegház
RO Seră de grădină



5901477186707

Szklarnia – tunel foliowy ogrodowy 3x2x2m UV **G73293** **1**

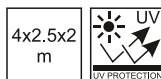

GB Garden greenhouse
DE Gartengewächshaus
RU Садовая теплица
CZ Zahradní skleník
SK Záhradný skleník
HU Kerti üvegház
RO Seră de grădină



5901477186691

Szklarnia – tunel foliowy ogrodowy 4x2.5x2m UV **G73294** **1**

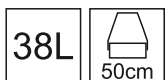

GB Garden roller
DE Gartenwalze
RU Садовый валик
CZ Zahradní válec
SK Záhradný valec
HU Kerti henger
RO Tavalug gradina



5901477160592

Walec ogrodowy 50cm 38L **G73320** **1**

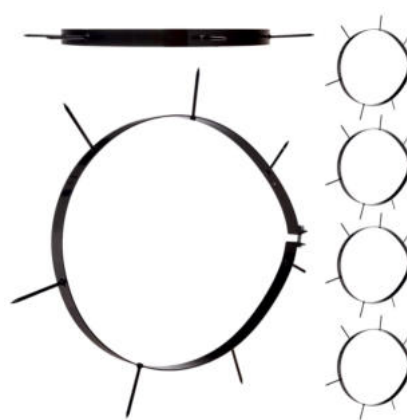

GB Ring with Spikes Mounting on Garden Roller
DE Ring mit Spikes Montage auf Gartenrolle
RU Кольцо с шипами для установки на садовый каток
CZ Kroužek s hroty pro montáž na zahradní válec
SK Krúžok s hrotmi na upevnenie na záhradný valec
HU Tűskés gyűrű kerti görgőre szerelve
RO Inel cu spițe Montare pe role de grădină



5901477183225

Kolce do walca ogrodowego 32cm 5szt. **G73321** **1**

76L
60x40cm



320 mm

7TPI
12TPI



GB Fertilizer and compost spreader
DE Dünger- und Kompoststreuer
RU Разбрасыватель удобрений и компоста
CZ Rozmetadlo hnojiva a kompostu
SK Rozmetadlo hnojiva a kompostu
HU Műtrágya- és komposztoszóró
RO Împrăștiător de îngrășământ și compost



Kod EAN
5903418300272

Rozsiewacz nawozu, kompostu 76L
Kod produktu G73322 1

GB Japanese style double-sided saw
DE Doppelseitige Säge im japanischen Stil
RU Двусторонняя пила в японском стиле.
CZ Oboustranná pila japonského stylu
SK Oboustranná pila v japonskom štyle
HU Japán stílusú kétoldalas fűrész
RO Ferăstrău dublu în stil japonez



Kod EAN
5901477178214

Pila dwustronna japońska 320mm
Kod produktu G33114 40

60cm



60cm



GB Garden machete
DE Garten Machete
RU Садовый мачете
CZ Zahradní mačeta
SK Záhradná mačeta
HU Kerti machete
RO Maceta de gradina



Kod EAN
5901477178023

Maczeta ogrodowa 60cm JG
Kod produktu G82955 48

GB Garden machete
DE Garten Machete
RU Садовый мачете
CZ Zahradní mačeta
SK Záhradná mačeta
HU Kerti machete
RO Maceta de gradina



Kod EAN
5901477178030

Maczeta ogrodowa z kaburą 60cm JG
Kod produktu G82956 48

PCV
UV PROTECTION
500L
3/4"
PRZYŁĄCZA I KRÓTCE



70x60cm
272L
145g/m²



GB Collapsible rainwater tank
DE Zusammenklappbarer Regenwassertank
RU Складной резервуар для дождевой воды
CZ Skládací nádrž na dešťovou vodu
SK Skladacia nádrž na dažďovú vodu
HU Összecsukható esőviztartály
RO Rezervor de apă de ploaie plabil



Kod EAN
5901477186738

Zbiornik składany PVC na wodę deszczową 500L
Kod produktu G73298 4

GB Garden leaf bag
DE Gartenabfallsack für Laub
RU Садовый мешок для листьев
CZ Zahradní koš na listie
SK Záhradný koš na listie
HU Kerti lombgyűjtő zsák
RO Coș de grădină pentru frunze



Kod EAN
5901477199400

Kosz ogrodowy na liście 272L
Kod produktu G73285 40



75L



GB Garden transport cart
DE Garten-Transportwagen
RU Садовая транспортная тележка
CZ Zahradní přepravní vozík
SK Záhradný prepravný vozík
HU Kerti szállítókosci
RO Cărucior de transport pentru grădină



Kod EAN
5903418300265

Wózek transportowy ogrodowy 75L Kod produktu **G71126** 1

100kg

127L



GB Foldable garden cart
DE Zusammenklappbarer Gartenwagen
RU Складная садовая тележка
CZ Skládací zahradní vozík
SK Skladací záhradný vozík
HU Összecsukható kerti kocsi
RO Cărucior de grădină pliant



Kod EAN
5901477183041

Wózek ogrodowy – plażowy składany 127L 100kg Kod produktu **G71109** 1

65cm



GB Manual sweeper for paving stones and driveways
DE Handkehrmaschine für Pflastersteine und Einfahrten
RU Ручная подметальная машина для брусчатки
CZ Ruční zametač na dlažbu a příjezdové cesty
SK Ručný zametač na dlažbu a príjazdové cesty
HU Kézi seprőgép térkőhöz és felhajtókhoz
RO Măturătoare manuală pentru pavaj și alei



Kod EAN
5901477168949

Zamiatarka ręczna do kostki/podjazdów 65cm JG Kod produktu **G83041** 1

53cm



GB Manual leaf sweeper
DE Handkehrmaschine für Laub
RU Ручная подметальная машина для листьев
CZ Ruční zametač na listí
SK Ručný zametač na listie
HU Kézi lombseprő
RO Măturătoare manuală pentru frunze



Kod EAN
5901477168932

Zamiatarka ręczna do liści 53cm JG Kod produktu **G83040** 1



GB Exhaust pipe cutter
DE Auspuff schneider
RU Резец выхлопной трубы
CZ Řezačka výfukových trubek
SK Rezačka výfukových potrubí
HU Kipufogócső-vágó
RO Evacuare-tăiere



Kod EAN
5901477160318

Kwasomierz- Miernik pH gleby, temperatury i oświetlenia Kod produktu **G73195** 35

150kg



GB Sawhorse - saw frame for chainsaws
DE Sawhorse - Sägegatter für Kettensägen
RU Пилорама - рама для бензопил
CZ Sawhorse - rám pily pro řetězové pily
SK Sawhorse - rám pre reťazové pily
HU Fűrészváz - fűrészkeret láncfűrészhez
RO Sawhorse - cadru pentru ferăstrăie cu lanț



Kod EAN
5901477188664

Kozioł składany do piłowania drewna 150kg Kod produktu **G10877** 1



75x25cm



GB Manual lawn level
DE Manueller Bodenplanierer
RU Ручной выравниватель грунта
CZ Ruční srovnávač terénu
SK Ručný vyrovnávač terénu
HU Kézi talajkiegyenlítő
RO Nivelator manual pentru teren



Kod EAN
5903418302030

Ręczny niwelator terenu 75x25cm Kod produktu **G73331** 1



90x30cm

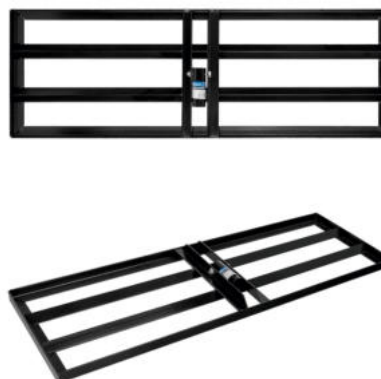

GB Manual lawn level
DE Manueller Bodenplanierer
RU Ручной выравниватель грунта
CZ Ruční srovnávač terénu
SK Ručný vyrovnávač terénu
HU Kézi talajkiegyenlítő
RO Nivelator manual pentru teren



Kod EAN
5903418302047

Ręczny niwelator terenu 90x30cm Kod produktu **G73332** 1



120x30cm

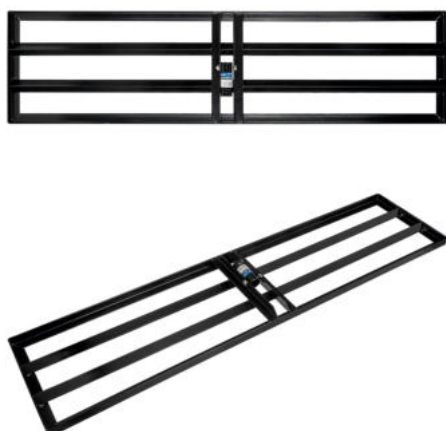

GB Manual lawn level
DE Manueller Bodenplanierer
RU Ручной выравниватель грунта
CZ Ruční srovnávač terénu
SK Ručný vyrovnávač terénu
HU Kézi talajkiegyenlítő
RO Nivelator manual pentru teren



Kod EAN
5903418302054

Ręczny niwelator terenu 120x30cm Kod produktu **G73333** 1



GB Weed snatcher
DE Unkrauträuber
RU Похититель сорняков
CZ Chytač plevelu
SK Chytač buriny
HU Weed snatcher
RO Weed snatcher



Kod EAN
5901477186578

Skrobak do usuwania trawy i chwastów Kod produktu **G72077** 40



77cm



GB Pick up tool
DE Aufnahmewerkzeug
RU Инструмент для подбора
CZ Nástroj pro vyzvednutí
SK Nástroj na vyzdvihnutie
HU Vedd fel a szerszámot
RO Instrumentul de ridicare



Kod EAN
5901477184024

Chwytnak aluminiowy 77cm Kod produktu **G03208** 120



10L



GB Universal collapsible silicone bucket
DE Universeller faltbarer Silikon-eimer
RU Универсальное складное ведро из силикона
CZ Univerzální skládací silikonové vědro
SK Univerzálne skládacie vedro zo silikónu
HU Összecsukható univerzális szilikon vödör
RO Găleată universală de silicon pliabilă



Kod EAN
5901477189241

Wiadro silikonowe uniwersalne składane 10L Kod produktu **G02633** 50



50mm
2x53mm
2x53mm



Kod EAN
5901477188602
Kod EAN
5901477188619
Kod EAN
5901477188626

GB Knee garden mat
DE Knie-Gartenmatte
RU Садовый коврик на коленях
CZ Zahradní podložka pod kolena
SK Záhradná podložka na kolena
HU Térd kerti szőnyeg
RO Covoraș de grădină pentru genunchi

Kod EAN
5901477189876

John Gardener Kod produktu
Mata – podkładka ogrodnicza pod kolana 400x200x20mm G72078 40

John Gardener Kod produktu
Ostrzałka do noży kosiarek na wiertarkę/wkrętarke 50mm G83060 150
Ostrzałka do noży kosiarek na wiertarkę/wkrętarke 2x53mm G83061 100
Ostrzałka podwójna do noży kosiarek na wiertarkę/wkrętarke 2x53mm G83062 100



6x4mm 10000 szt.

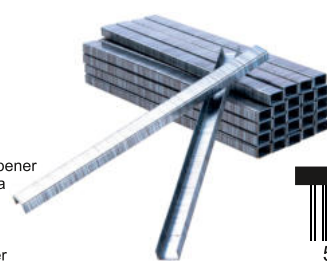

GB Staples for tapener
DE Hefklammern für Tapener
RU Скобы для тапенера
CZ Sponky do tapeneru
SK Sponky do tapenera
HU Kapcsok tapenerhez
RO Capse pentru tapener

Kod EAN
5901477198243

John Gardener Kod produktu
Zszywki do tapenera G72009 10000szt G72009A 100

GB Garden tapener for tying plants
DE Garten-Tapener zum Binden von Pflanzen
RU Садовый тапeнер для подвязки растений
CZ Zahradnický tapener pro vázání rostlin
SK Záhradnický tapener na viazanie rastlín
HU Kerti kötözógép növényekhez
RO Tapener pentru legarea plantelor

Kod EAN
5901477198229

John Gardener Kod produktu
Zszywacz ogrodniczy – tapener szkółkarski do wiązania roślin G72009 20

10mm 22 m



GB Green tape for tapener
DE Grünes Band für Tapener
RU Зелёная лента для тапенера
CZ Zelená páska do tapeneru
SK Zelená páska do tapenera
HU Zöld szalag tapenerhez
RO Bandă verde pentru tapener

Kod EAN
5901477198236

John Gardener Kod produktu
Taśma zielona 22m do tapenera G72009 G72009B 10/100

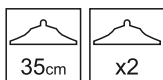

14.5x11 cm



GB Plastic manure scraper
DE Kunststoff-Mistschaber
RU Пластиковый скребок для навоза
CZ Plastová stěrka na hnůj
SK Plastová stierka na hnoj
HU Műanyag trágyakaparó
RO Racletă din plastic pentru gunoi de grajd

Kod EAN
5903418300555

John Gardener Kod produktu
Zgniacz plastikowy do obornika 35cm G66544 2/50

GB Guillotine trap for moles and voles
DE Guillotinfalle für Maulwürfe und Wühlmäuse
RU Гильотинная ловушка для кротов и полёвок
CZ Gilotinová past na krtky a hraboše
SK Gilotinová pasca na krtkov a hraboše
HU Guillotine csapda vakondokhoz és pockokhoz
RO Carpană ghilotină pentru cârțițe și șoareci de câmp

Kod EAN
5903418305321

John Gardener Kod produktu
Pułapka – gilotylna na krety i normice 14,5x11cm K02519 10/40



GB Glue mouse trap
DE Klebmausfalle
RU Ловушка для мышей из клея
CZ Lepicí past na myši
SK Lepiaca pasca na myši
HU Ragasztó egércsapda
RO Capcană pentru șoareci cu lipici



Kod EAN
5901477188374

pułapka lep na myszy i szczury Kod produktu **K02500** **200**



GB Human live catch mouse trap
DE Lebendfangmausfalle für Menschen
RU Человеческая ловушка для живых мышей
CZ Past na lidské myši
SK Ľudská živá pasca na myši
HU Emberi élő egércsapda
RO Capcană pentru șoareci cu capcană umană vie



Kod EAN
5901477188510

Pułapka żywołapka na myszy i szczury 2szt Kod produktu **K02508** **30**



GB Strong classic mouse trap
DE Starke klassische Mausfalle
RU Сильная классическая мышеловка
CZ Silná klasická past na myši
SK Silná klasická pasca na myši
HU Erős klasszikus egércsapda
RO Capcană clasică puternică pentru șoareci



Kod EAN
5901477188497

Pułapka klasyczna na myszy i szczury Kod produktu **K02505** **140**



GB Human live catch mouse trap
DE Lebendfangmausfalle für Menschen
RU Человеческая ловушка для живых мышей
CZ Past na lidské myši
SK Ľudská živá pasca na myši
HU Emberi élő egércsapda
RO Capcană pentru șoareci cu capcană umană vie



Kod EAN
5901477188527

Pułapka żywołapka metalowa na myszy i szczury Kod produktu **K02510** **20**

60x21x18
cm



GB Human live catch mouse trap
DE Lebendfangmausfalle für Menschen
RU Человеческая ловушка для живых мышей
CZ Past na lidské myši
SK Ľudská živá pasca na myši
HU Emberi élő egércsapda
RO Capcană pentru șoareci cu capcană umană vie



Kod EAN
5901477189869

Pułapka żywołapka metalowa składana na kuny, lasice i szczury Kod produktu **K02513** **8**



GB Electric fly swatter
DE Elektro-Fliegenklatsche
RU Электромухобойка
CZ Elektrická plácačka na mouchy
SK Elektrická plácačka na muchy
HU Elektromos légycsapó
RO Pălărie electrică pentru muște



Kod EAN
5901477188404

Elektryczna packa na owady Kod produktu **K02524** **100**



GB UV insect killer lamp
DE UV-Insektenvernichter Lampe
RU УФ-лампа для борьбы с насекомыми
CZ UV lampa proti hmyzu
SK UV žiarovka proti hmyzu
HU UV rovarirtó lámpa
RO Lampa ucigașă pentru insecte UV



Kod EAN
5901477189968

Lampa owadobójcza UV 20W Kod produktu **G80492** **10**



GB UV insect killer lamp
DE UV-Insektenvernichter Lampe
RU УФ-лампа для борьбы с насекомыми
CZ UV lampa proti hmyzu
SK UV žiarovka proti hmyzu
HU UV rovarirtó lámpa
RO Lampa ucigașă pentru insecte UV



Kod EAN
5901477189975

Lampa owadobójcza UV 30W Kod produktu **G80493** **10**



GB Fly swatter
DE Fliegenklatsche
RU Мухобойка
CZ Plácačka na mouchy
SK Plátačka na muchy
HU Légycsapó
RO Pălărie de muște



Kod EAN
5901477188398

Packa – łapka na muchy – mix kolor Kod produktu **K02521** **500**



GB Fly swatter
DE Fliegenklatsche
RU Мухобойка
CZ Plácačka na mouchy
SK Plátačka na muchy
HU Légycsapó
RO Pălărie de muște



Kod EAN
5901477188381

Packa na muchy – mix kolor Kod produktu **K02520** **1000**



GB Bug & Fly trap with attractant
DE Wanzen- und Fliegenfalle mit Lockstoff
RU Ловушка для клопов и мух с аттрактантом
CZ Past na brouky a mouchy s atraktantem
SK Pasca na chrobáky a muchy s atraktantom
HU Bogár- és légycsapda csalogatószerrel
RO Capcană pentru insecte și muște cu atractant



Kod EAN
5901477188534

Pułapka z wabikiem na muchy i inne owady latające Kod produktu **K02529** **40**



GB Sticky fly paper
DE Klebriges Fliegenpapier
RU Липкая бумага для мух
CZ Lepicí papír na mouchy
SK Lepkavý muškársky papier
HU Ragadós légyapír
RO Hârtie lipicioasă pentru muște



Kod EAN
5901477188565

Lep na muchy i inne owady latające 4szt x 80cm Kod produktu **K02527** **288**



GB Raschel bag
DE Rascheltasche
RU Сумка рашель
CZ Rašlová taška
SK Rašlová taška
HU Raschel táska
RO Geanta raschel



Kod produktu	100/2000 /6000
Worek raszlowy z zaciągami 30x50cm 5kg /Biały G71980A	100/2000 /6000
Worek raszlowy z zaciągami 42x60cm 15kg /Biały G71981A	100/2000 /6000
Worek raszlowy z zaciągami 50x80cm 30kg /Biały G71982A	100/2000 /6000



GB Raschel bag
DE Rascheltasche
RU Сумка рашель
CZ Rašlová taška
SK Rašlová taška
HU Raschel táska
RO Geanta raschel



Kod produktu	100/2000 /6000
Worek raszlowy z zaciągami 30x50cm 5kg /Pomarańczowy G71980B	100/2000 /6000
Worek raszlowy z zaciągami 42x60cm 15kg /Pomarańczowy G71981B	100/2000 /6000
Worek raszlowy z zaciągami 50x80cm 30kg /Pomarańczowy G71982B	100/2000 /6000



GB Polypropylene bag
DE Beutel aus Polypropylen
RU Полипропиленовый мешок
CZ Polypropylenový sáček
SK Polypropylénové vrecko
HU Polipropilén táska
RO Geanta din polipropilena



Kod produktu	100/1000
Worek polipropylenowy 50x80cm 30kg /Biały G71983A	100/1000
Worek polipropylenowy 65x105cm 50kg /Biały G71984A	100/500
Worek polipropylenowy 80x125cm 80kg /Biały G71985A	100/500



GB Polypropylene bag
DE Beutel aus Polypropylen
RU Полипропиленовый мешок
CZ Polypropylenový sáček
SK Polypropylénové vrecko
HU Polipropilén táska
RO Geanta din polipropilena

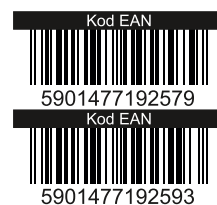

Kod produktu	100/1000
Worek polipropylenowy 50x80cm 30kg /Niebiesko-czerwony G71983B	100/1000
Worek polipropylenowy 65x105cm 50kg /Niebiesko-czerwony G71984B	100/500

Oświetlenie / Lighting



4500K



GB UFO LED high bay light
 DE LED-Industrieleuchte Typ UFO
 RU Промышленный LED-светильник типа UFO
 CZ Průmyslové LED svítidlo typu UFO
 SK Priemyselné LED svietidlo typu UFO
 HU UFO típusú ipari LED lámpa
 RO Lampă industrială LED tip UFO

keltin	Kod produktu	
Lampa przemysłowa LED typu UFO 100W 12000LM	K02073	10
Lampa przemysłowa LED typu UFO 150W 18000LM	K02074	10
Lampa przemysłowa LED typu UFO 200W 24000LM	K02075	10

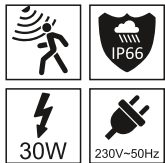

GB LED lamp with motion detector
 DE Diodenscheinwerfer mit Bewegungsmelder
 RU Светодиодный прожектор с датчиком движения
 CZ LED refl ektor se snímačem pohybu
 SK LED reflektor so snímačom pohybu
 HU Diódás refl ektor mozgásérzékelővel
 RO Refl ector diodă cu senzor de mișcare

keltin	Kod produktu	
Naświetlacz LED 30W z czujnikiem ruchu-biała zimna 6500K	K02010	40
Naświetlacz LED 30W z czujnikiem ruchu-biała neutralna 4500K	K02011	40
Naświetlacz LED 30W z czujnikiem ruchu-biała ciepła 2700K	K02012	40



GB LED lamp with motion detector
 DE Diodenscheinwerfer mit Bewegungsmelder
 RU Светодиодный прожектор с датчиком движения
 CZ LED refl ektor se snímačem pohybu
 SK LED reflektor so snímačom pohybu
 HU Diódás refl ektor mozgásérzékelővel
 RO Refl ector diodă cu senzor de mișcare

keltin	Kod produktu	
Naświetlacz LED 50W z czujnikiem ruchu-biała zimna 6500K	K02013	20
Naświetlacz LED 50W z czujnikiem ruchu-biała neutralna 4500K	K02014	20
Naświetlacz LED 50W z czujnikiem ruchu-biała ciepła 2700K	K02015	20



GB LED lamp with motion detector
 DE Diodenscheinwerfer mit Bewegungsmelder
 RU Светодиодный прожектор с датчиком движения
 CZ LED refl ektor se snímačem pohybu
 SK LED reflektor so snímačom pohybu
 HU Diódás refl ektor mozgásérzékelővel
 RO Refl ector diodă cu senzor de mișcare

keltin	Kod produktu	
Naświetlacz LED 100W z czujnikiem ruchu-biała zimna 6500K	K02016	10
Naświetlacz LED 100W z czujnikiem ruchu-biała neutralna 4500K	K02017	10
Naświetlacz LED 100W z czujnikiem ruchu-biała ciepła 2700K	K02018	10



GB LED lamp with motion detector
 DE Diodenscheinwerfer mit Bewegungsmelder
 RU Светодиодный прожектор с датчиком движения
 CZ LED reflektor se snímačem pohybu
 SK LED reflektor so snímačom pohybu
 HU Diódás reflektor mozgásérzékelővel
 RO Reflector diodă cu senzor de mișcare

keltin	Kod produktu	
Lampa solarna z czujnikiem zmierzchu i ruchu 50W	K02025	100

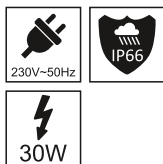

GB LED lamp
DE Diodenscheinwerfer
RU Светодиодный прожектор
CZ LED refl ektor
SK LED reflektor
HU Diódás refl ektor
RO Refl ector diodă



Keltin		Kod produktu	
Naświetlacz LED 30W – barwa biała zimna 6500K	K02030	80	
Naświetlacz LED 30W – barwa biała neutralna 4500K	K02031	80	
Naświetlacz LED 30W – barwa biała ciepła 2700K	K02032	80	

GB LED lamp
DE Diodenscheinwerfer
RU Светодиодный прожектор
CZ LED refl ektor
SK LED reflektor
HU Diódás refl ektor
RO Refl ector diodă



Keltin		Kod produktu	
Naświetlacz LED 50W – barwa biała zimna 6500K	K02033	40/50	
Naświetlacz LED 50W – barwa biała neutralna 4500K	K02034	40/50	
Naświetlacz LED 50W – barwa biała ciepła 2700K	K02035	40/50	

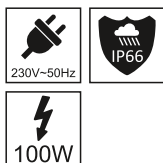

GB LED lamp
DE Diodenscheinwerfer
RU Светодиодный прожектор
CZ LED refl ektor
SK LED reflektor
HU Diódás refl ektor
RO Refl ector diodă



Keltin		Kod produktu	
Naświetlacz LED 100W –barwa biała zimna 6500K	K02036	20	
Naświetlacz LED 100W –barwa biała neutralna 4500K	K02037	20	
Naświetlacz LED 100W –barwa biała ciepła 2700K	K02038	20	

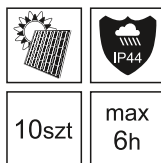

GB Solar garden lamp
DE Solar-Gartenlampe
RU Садовый фонарь на солнечных батареях
CZ Solární zahradní lampa
SK Solárna záhradná lampa
HU Napelemes kerti lámpa
RO Lampă solară de grădină



Keltin		Kod produktu	
Lampa solarna ogrodowa gruntowa wbijana 4,5x4,5cmx30cm	K02027	300	

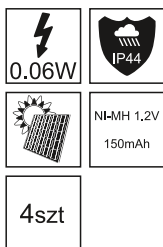

GB Solar garden lamp
DE Solar-Gartenlampe
RU Садовый фонарь на солнечных батареях
CZ Solární zahradní lampa
SK Solárna záhradná lampa
HU Napelemes kerti lámpa
RO Lampă solară de grădină



Keltin		Kod produktu	
Lampa solarna ogrodowa gruntowa wbijana 6x6x40cm	K02029	60	

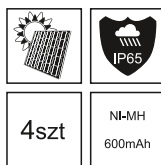

GB Solar garden lamp set
DE Solar-Gartenlampen-Set
RU Набор садовых ламп на солнечных батареях
CZ Sada solárních zahradních lamp
SK Súprava solárnych záhradných lamp
HU Napelemes kerti lámpa készlet
RO Set de lămpi solare pentru grădină



Keltin		Kod produktu	
Lampa solarna ogrodowa 16LED gruntowa najazdowa (4szt.)	K02028	6	

Myjki ciśnieniowe i akcesoria

/ Pressure Washers and accessories



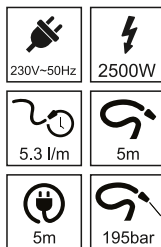
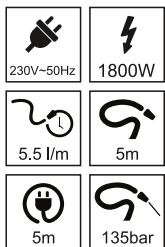

GB High pressure washer
DE Hochdruckreiniger
RU Мойка высокого давления
CZ Vysokotlaké myčky
SK Vysokotlaková umývačka
HU Magasnyomású mosó
RO Spălător de înaltă presiune



John Gardēner
Myjka ciśnieniowa JG 90/135 BAR 1800W
Kod produktu G81665 1

GB High pressure washer
DE Hochdruckreiniger
RU Мойка высокого давления
CZ Vysokotlaké myčky
SK Vysokotlaková umývačka
HU Magasnyomású mosó
RO Spălător de înaltă presiune



John Gardēner
Myjka ciśnieniowa z dodatk. wyposażeniem JG 130/195 BAR
Kod produktu G81666 1



GB Pressure washer foam spray nozzle
DE Hochdruckreiniger schaum sprühdüse
RU Пенная насадка
CZ Šampónovací tryska
SK Šampónovací tryska
HU Habosító fúvóka
RO Dispozitiv de spumare cu rezervor



PIANOWNICA do myjek ciśnieniowych serii HD z adapterem 1L
Kod produktu G73140 20



GB Pressure washer foam spray nozzle
DE Hochdruckreiniger schaum sprühdüse
RU Пенная насадка
CZ Šampónovací tryska
SK Šampónovací tryska
HU Habosító fúvóka
RO Dispozitiv de spumare cu rezervor



PIANOWNICA do myjek ciśnieniowych serii K2-K7 z adapterem 1L
Kod produktu G73141 30



GB Pressure washer foam spray nozzle
DE Hochdruckreiniger schaum sprühdüse
RU Пенная насадка
CZ Šampónovací tryska
SK Šampónovací tryska
HU Habosító fúvóka
RO Dispozitiv de spumare cu rezervor



PIANOWNICA do myjek ciśnieniowych serii K
Kod produktu G73142 40



GB Pressure washer foam spray nozzle
DE Hochdruckreiniger schaum sprühdüse
RU Пенная насадка
CZ Šampónovací tryska
SK Šampónovací tryska
HU Habosító fúvóka
RO Dispozitiv de spumare cu rezervor



PIANOWNICA do myjek ciśnieniowych Hobby
Kod produktu G73143 40



GB Strainer
DE Sieb
RU Стяжка
CZ Sedník
SK Cedidlo
HU Szűrő
RO Strecurătoare



SITKO do pianownic profesjonalnych
Kod produktu G73144 250



GB Universal brush
DE Universalbürste
RU Универсальная щетка
CZ Univerzální kartáč
SK Univerzálna kefa
HU Univerzális kefe
RO Perie universală



Szczotka uniwersalna do myjki ciśnieniowej
Kod produktu G81620 30



GB Rotary brush
DE Drehbürste
RU Вращающаяся щетка
CZ Rotační kartáč
SK Rotačná kefa
HU Forgó kefe
RO Pensulă rotativă



Szczotka rotacyjna do myjki ciśnieniowej
Kod produktu G81621 20



GB Nozzle
DE Düse
RU Сопло
CZ Tryska
SK Tryska
HU Fúvóka
RO Duză



Dysza turbo do myjki ciśnieniowej
Kod produktu G81622 1



GB Patio cleaner
DE Flächenreiniger
RU Насадки для мойки плоских
CZ Čistič teras
SK Čistič terás
HU Felületisztító
RO Curățător de terasă

Kod EAN
5901477140068

Kod produktu
G81623 25

Patio Cleaner do myjki ciśnieniowej



GB Reduction
DE Reduzierung
RU Сокращение
CZ Redukce
SK Redukcia
HU Csökkentés
RO Reducere

Kod EAN
5901477141232

Kod produktu
G73104 50

Adapter do podłączenia akcesoriów z serii K do Myjek HD/HDS



GB Nozzle
DE Düse
RU Conno
CZ Tryska
SK Tryska
HU Fúvóka
RO Duză

Kod EAN
5901477141140

Kod produktu
G73106 100

Dysza trójstopniowa przestawna do myjki z gwintem 1/4"



GB Nozzle
DE Düse
RU Conno
CZ Tryska
SK Tryska
HU Fúvóka
RO Duză

Kod EAN
5901477141133

Kod produktu
G73107 500

Dysza wody do myjek ciśnieniowych serii HD/HDS



GB Nozzle
DE Düse
RU Conno
CZ Tryska
SK Tryska
HU Fúvóka
RO Duză

Kod EAN
5901477141126

Kod produktu
G73108 100

Dysza wody+ nakrętka do myjek ciśnieniowych serii HD/HDS



GB Nozzle
DE Düse
RU Conno
CZ Tryska
SK Tryska
HU Fúvóka
RO Duză

Kod EAN
5901477141119

Kod produktu
G73109 50

Kompletny zestaw naprawczy turbodyszy myjek ciśnieniowych



GB Nozzle
DE Düse
RU Conno
CZ Tryska
SK Tryska
HU Fúvóka
RO Duză

Kod EAN
5901477141089

Kod produktu
G73110 150

Obudowa dyszy rotacyjnej serii K



GB Lance rotating
DE Lanze drehend
RU Копье вращающееся
CZ Trubice s rotující tryskou
SK Trubica s rotujúcou tryskou
HU Lándzsa forgó
RO Lance pentru pistol

Kod EAN
5901477141065

Kod produktu
G73112 100

Dysza rotacyjna turbodysza



GB Lance rotating
DE Lanze drehend
RU Копье вращающееся
CZ Trubice s rotující tryskou
SK Trubica s rotujúcou tryskou
HU Lándzsa forgó
RO Lance pentru pistol

Kod EAN
5901477141058

Kod produktu
G73113 50

Dysza rotacyjna turbodysza do Karcher K2-K6



GB Lance rotating
DE Lanze drehend
RU Копье вращающееся
CZ Trubice s rotující tryskou
SK Trubica s rotujúcou tryskou
HU Lándzsa forgó
RO Lance pentru pistol

Kod EAN
5901477141041

Kod produktu
G73114 50

Lanca kątowa do podwozi myjki Karcher K2-K7



GB Pressure cleaning gun
DE Spritzlanze für Rückenspritzgerät
RU Профессиональная насадка к опрыскивателю
CZ Tlakové pistole
SK Tlakové pištole
HU Magasnyomású pisztoly
RO Pistol pentru aparat de spălat cu presiune

Kod EAN
5901477141034

Kod produktu
G73115 10

Profesjonalna lanca do myjki wysokociśnieniowej M22 345 BAR



GB High pressure washer gun
DE Hochdruckpistole
RU Пистолет высокого давления
CZ Vysokotlaká ostříkovač
SK Vysokotlakové ostrekovač
HU Nagynyomású mosó pisztoly
RO Pistol inalta presiune

Kod EAN
5901477141027

Kod produktu
G73116 25

Pistolet do myjki wysokociśnieniowej 345 BAR



GB High pressure washer gun
DE Hochdruckpistole
RU Пистолет высокого давления
CZ Vysokotlaká ostříkovač
SK Vysokotlakové ostrekoávač
HU Nagynyomású mosó pisztoly
RO Pistol inalta presiune

Kod EAN
5901477141010

Kod produktu
G73117 20

Pistolet do myjki wysokociśnieniowej 280 BAR



GB Pressure cleaning gun
DE Spritzlanze für Rückenspritzgerät
RU Профессиональная насадка к опрыскивателю
CZ Tlakové pistole
SK Tlakové pištole
HU Magasnyomású pisztoly
RO Pistol pentru aparat de spalat cu presiune

Kod EAN
5901477126246

Kod produktu
G73118 20

Profesjonalna lanca do myjki wysokociśnieniowej M22 280BAR



GB Pressure cleaning gun
DE Spritzlanze für Rückenspritzgerät
RU Профессиональная насадка к опрыскивателю
CZ Tlakové pistole
SK Tlakové pištole
HU Magasnyomású pisztoly
RO Pistol pentru aparat de spalat cu presiune

Kod EAN
5901477120961

Kod produktu
G73119 25

Lanca do myjki ciśnieniowej metal złącze 150 BAR



GB Pressure cleaning gun
DE Spritzlanze für Rückenspritzgerät
RU Профессиональная насадка к опрыскивателю
CZ Tlakové pistole
SK Tlakové pištole
HU Magasnyomású pisztoly
RO Pistol pentru aparat de spalat cu presiune

Kod EAN
5901477117831

Kod produktu
G73120 25

Lanca do myjki wysokociśnieniowej gwint 14mm

5m



GB High pressure cleaning hose
DE Schlange für Rückenspritzgerät
RU Шланг высокого давления
CZ Tlaková hadice pro vysokotlaký čistič
SK Tlaková hadica pre vysokotlakový čistič
HU Magasnyomású tömlő magasnyomású mosóhoz
RO Furtun de inalta presiune pentru

Kod EAN
5901477117848

Kod produktu
G73121 25

Wąż do myjki wysokociśnieniowej 5m

10m



GB High pressure cleaning hose
DE Schlange für Rückenspritzgerät
RU Шланг высокого давления
CZ Tlaková hadice pro vysokotlaký čistič
SK Tlaková hadica pre vysokotlakový čistič
HU Magasnyomású tömlő magasnyomású mosóhoz
RO Furtun de inalta presiune pentru

Kod EAN
5901477117855

Kod produktu
G73122 20

Wąż do myjki wysokociśnieniowej 10m

10m



GB High pressure cleaning hose
DE Schlange für Rückenspritzgerät
RU Шланг высокого давления
CZ Tlaková hadice pro vysokotlaký čistič
SK Tlaková hadica pre vysokotlakový čistič
HU Magasnyomású tömlő magasnyomású mosóhoz
RO Furtun de inalta presiune pentru

Kod EAN
5901477141164

Kod produktu
G73123 5

Wąż wysokociśnieniowy 10m do myjek serii HD/HDS

10m



GB High pressure cleaning hose
DE Schlange für Rückenspritzgerät
RU Шланг высокого давления
CZ Tlaková hadice pro vysokotlaký čistič
SK Tlaková hadica pre vysokotlakový čistič
HU Magasnyomású tömlő magasnyomású mosóhoz
RO Furtun de inalta presiune pentru

Kod EAN
5901477141171

Kod produktu
G73124 20

Wąż wysokociśnieniowy 10m do myjek serii K

15m



GB High pressure cleaning hose
DE Schlange für Rückenspritzgerät
RU Шланг высокого давления
CZ Tlaková hadice pro vysokotlaký čistič
SK Tlaková hadica pre vysokotlakový čistič
HU Magasnyomású tömlő magasnyomású mosóhoz
RO Furtun de inalta presiune pentru

Kod EAN
5901477141188

Kod produktu
G73125 20

Wąż do czyszczenia kanalizacji 15m dla myjek serii K



GB Filter
DE Filter
RU Фильтр
CZ Filtr
SK Filter
HU Szűrő
RO Filtru

Kod EAN
5901477141096

Kod produktu
G73130 700

Filtr wody złączka do myjki na kran 3/4" serii K





GB Filter
DE Filter
RU Фильтр
CZ Filtr
SK Filter
HU Szűrő
RO Filtru

Kod EAN
5901477141102

Kod produktu
G73131 175

Filtr wody do myjek ciśnieniowych 3/4"

GB Taper reducer
DE Verlängerungsstück
RU Ниппель
CZ Vsvukva s kuželovým závitom
SK Vsvukva s kuželovým závitom
HU Kúpos menet
RO Reducție

Kod EAN
5901477143076

Kod produktu
G73132 100

Nypel 1/4" - 1/4" redukcja złączka do pianownicy



GB Plug
DE Stecker
RU Штпсель
CZ Svíčka
SK Sviečka
HU Dugó
RO Dop



Wtyk do węży myjek ciśnieniowych serii K dn6 G73133 300



GB Plug
DE Stecker
RU Штпсель
CZ Svíčka
SK Sviečka
HU Dugó
RO Dop



Wtyk do węży myjek ciśnieniowych Nilfisk ST dn6 G73134 1



GB Reduction
DE Reduzierung
RU Сокращение
CZ Redukce
SK Redukcia
HU Csökkentés
RO Reducere



Redukcja Bayonet do myjek ciśnieniowych serii K 1/4" G73135 150



GB Reduction
DE Reduzierung
RU Сокращение
CZ Redukce
SK Redukcia
HU Csökkentés
RO Reducere



Redukcja Bayonet do myjek ciśnieniowych serii K 1/4" mosiądz G73136 1



GB Lance rotating
DE Lanze drehend
RU Конь вращающееся
CZ Trubice s rotující tryskou
SK Trubica s rotujúcou tryskou
HU Lándzsá forgó
RO Lance pentru pistol



Lanca gięta 15° + komplet 5 dysz G73145 100

1L



GB Pressure washer foam spray nozzle
DE Hochdruckreiniger schaum sprühdüse
RU Пенная насадка
CZ Šamponovací tryska
SK Šamponovací tryska
HU Habosító fúvóka
RO Dispozitiv de spumare cu rezervor



Pianownica 1000ml na szybkozłącze G73147 50



GB Nozzle
DE Düse
RU Сопло
CZ Tryska
SK Tryska
HU Fúvóka
RO Duză



Kpl. dysz na szybkozłącze do myjek ciśnieniowych 5el. G73146 200



GB Pressure washer motor
DE Motor für Hochdruckreiniger
RU Двигатель для мойки высокого давления
CZ Motor pro vysokotlaký čistič
SK Motor pre vysokotlakový čistič
HU Motor magasnyomású mosóhoz
RO Motor pentru aparat de spălat cu presiune



Silnik do myjki ciśnieniowej JG 90/135 BAR 1800W G81665A 2



Sprzęt i akcesoria turystyczne

/ Tourist Equipment & Accessories



GB Multifunctional multitool
 DE Multifunktionswerkzeug
 RU Многофункциональный мультитул
 CZ Multifunkční multitool
 SK Multifunkčný multitool
 HU Multifunkciós szerszám
 RO Multitool multifuncțional



Kod EAN
 5903418300395
 Kod produktu

Multitool wielofunkcyjny GRIP BLACK SURVIVAL SERIES G01905 48



GB Multifunctional multitool
 DE Multifunktionswerkzeug
 RU Многофункциональный мультитул
 CZ Multifunkční multitool
 SK Multifunkčný multitool
 HU Multifunkciós szerszám
 RO Multitool multifuncțional



Kod EAN
 5903418300388
 Kod produktu

Multitool wielofunkcyjny SPARK BLACK SURVIVAL SERIES G01904 40



GB Tactical knife with holster
 DE Taktisches Messer mit Holster
 RU Тактический нож с кобурой
 CZ Taktický nůž s pouzdem
 SK Taktický nůž s puzdrom
 HU Taktikai kés tokban
 RO Cuțit tactic cu teacă



Kod EAN
 5901477193545
 Kod produktu

Nóż taktyczny 275/135mm z kaburą BLACK SURVIVAL SERIES G01890 6/24



GB Tactical knife with holster
 DE Taktisches Messer mit Holster
 RU Тактический нож с кобурой
 CZ Taktický nůž s pouzdem
 SK Taktický nůž s puzdrom
 HU Taktikai kés tokban
 RO Cuțit tactic cu teacă



Kod EAN
 5901477193552
 Kod produktu

Szczyroryk taktyczny 200/85mm BLACK SURVIVAL SERIES G01891 12/72



GB Tactical knife with holster
 DE Taktisches Messer mit Holster
 RU Тактический нож с кобурой
 CZ Taktický nůž s pouzdrém
 SK Taktický nůž s puzdrom
 HU Taktikai kés tokban
 RO Cuțit tactic cu teacă



Kod EAN
 5901477193569

Nóż finka taktyczny 215/105mm z kaburą BLACK SURVIVAL SERIES G01892 12/48



GB Tactical knife with holster
 DE Taktisches Messer mit Holster
 RU Тактический нож с кобурой
 CZ Taktický nůž s pouzdrém
 SK Taktický nůž s puzdrom
 HU Taktikai kés tokban
 RO Cuțit tactic cu teacă



Kod EAN
 5901477193576

Nóż finka taktyczny 215/105mm z kaburą BLACK SURVIVAL SERIES – kartonik wystawowy G01892A 12/48



GB Multifunctional shovel
 DE Kombi-faltschaufel
 RU Многофункциональная лопата
 CZ Lopatka víceúčelová
 SK Lopatka viacúčelová
 HU Többfunkciós ásó
 RO Lopata multifunctionala



Kod EAN
 5901477193583

Saperka składana 2w1 taktyczna BLACK SURVIVAL SERIES G01901 40



GB Multifunctional shovel
 DE Kombi-faltschaufel
 RU Многофункциональная лопата
 CZ Lopatka víceúčelová
 SK Lopatka viacúčelová
 HU Többfunkciós ásó
 RO Lopata multifunctionala



Kod EAN
 5901477193590

Saperka składana 5w1 taktyczna BLACK SURVIVAL SERIES G01902 24



GB Multifunctional shovel – entrenching tool
 DE Multifunktionsschaufel – Klappspaten
 RU Многофункциональная лопата – сапёрная лопатка
 CZ Multifunkční lopata – rolní lopatka
 SK Multifunkčná lopata – saperka
 HU Többfunkciós ásó – saperka
 RO Lopată multifuncțională – lopată de infanterie



Kod EAN
 5903418301729

Łopata wielofunkcyjna – saperka 70cm HARD-LINE G66554 6



GB Multifunctional shovel
 DE Kombi-faltschaufel
 RU Многофункциональная лопата
 CZ Lopatka víceúčelová
 SK Lopatka viacúčelová
 HU Többfunkciós ásó
 RO Lopata multifunctionala



Kod EAN
 5901477193606

Saperka składana wielozadaniowa taktyczna BLACK SURVIVAL SERIES G01903 20



GB Multifunctional shovel
 DE Kombi-faltschaufel
 RU Многофункциональная лопата
 CZ Lopatka víceúčelová
 SK Lopatka viacúčelová
 HU Többfunkciós ásó
 RO Lopata multifunctionala



5901477168482

Saperka - narzędzie wielofunkcyjne Kod produktu **G02420** 30



15W
 IPX8



GB Tactical flashlight
 DE Taktische Taschenlampe
 RU Тактический фонарь
 CZ Taktická svítilna
 SK Taktická baterka
 HU Taktikai zseblámpa
 RO Lanternă tactică



5901477192753

Latarka taktyczna LED XHP50 15W 1800mAh 1500lm IPX3 G15122 30



GB LED head lamp
 DE LED kopflampe
 RU Налобный светодиодный фонарь
 CZ LED montážní lampa - čelovka
 SK LED montážna lampa - čelovka
 HU LED fejlámpa
 RO Lampa cu LED



5901477163524

Lampa czołowa CREE XM-L T6 LED 1000lm Kod produktu **G15115** 50



GB Led neck light
 DE LED-Nackenlicht
 RU Светодиодный фонарь на шею
 CZ LED světlo na krk
 SK Led svetlo na krk
 HU LED nyaki lámpa
 RO Lumină LED pentru gât



5901477174032

Wielofunkcyjna lampka LED na szyję Kod produktu **G15112** 80

300 lm 6W COB
 500 mAh IPX4



GB Mini pocket flashlight with magnet
 DE Mini-Taschenlampe mit Magnet
 RU Мини-фонарь карманный с магнитом
 CZ Mini kapesní svítilna s magnetem
 SK Mini vrecková baterka s magnetom
 HU Mini zseblámpa mágnessel
 RO Mini lanternă de buzunar cu magnet



5901477192876

Latarka mini - kieszonkowa z magnesem LED COB 6W 500mAh Kod produktu **K02004** 18/216

500 lm 10W COB
 500 mAh IPX5



GB Mini tactical flashlight
 DE Mini-Taschenlampe taktisch
 RU Мини-тактический фонарь
 CZ Mini taktická svítilna
 SK Mini taktická baterka
 HU Mini taktikai zseblámpa
 RO Mini lanternă tactică



5901477192883

Latarka mini - taktyczna LED COB 10W 500mAh 500lm IPX5 Kod produktu **K02005** 12/96



GB Tourist gas stove
DE Touristischer Gashernd
RU Туристическая газовая плита
CZ Turistický plynový sporák
SK Turistický plynový sporák
HU Turisztikai gáztűzhely
RO Aragaz turistic

Kod EAN
5901477173929

Kod produktu
G80518 48



GB Butan Gas Cartridge
DE Butangaskartusche
RU Бутановый газовый баллончик
CZ Butanová plynová kazeta
SK Butánová plynová kazeta
HU Bután gázpatron
RO Cartuş cu gaz butan

Kod EAN
5903240385003

Kod produktu
G20076 28



GB Butan Gas Cartridge
DE Butangaskartusche
RU Бутановый газовый баллончик
CZ Butanová plynová kazeta
SK Butánová plynová kazeta
HU Bután gázpatron
RO Cartuş cu gaz butan

Kod EAN
5201811001049

Kod produktu
G20075 4



GB Grill
DE Grill
RU Гриль
CZ Gril
SK Gril
HU Rostély
RO Grătar

Kod EAN
5901477156717

Kod produktu
G80523 12



GB Tourist gas stove
DE Touristischer Gashernd
RU Туристическая газовая плита
CZ Turistický plynový sporák
SK Turistický plynový sporák
HU Turisztikai gáztűzhely
RO Aragaz turistic

Kod EAN
5901477133619

Kod produktu
G80521 30



GB Tourist gas stove
DE Touristischer Gashernd
RU Туристическая газовая плита
CZ Turistický plynový sporák
SK Turistický plynový sporák
HU Turisztikai gáztűzhely
RO Aragaz turistic

Kod EAN
5901477140327

Kod produktu
G80522 6



GB Tourist shower
DE Touristendusche
RU Туристический душ
CZ Turistická sprcha
SK Turistická sprcha
HU Turisztikai zuhany
RO Duş turistic

Kod EAN
5901477176739

Kod produktu
K00400 50



52cc
3200-3300rpm
25 : 1
1100ml

GB Boat engine
DE Bootsmotor
RU Лодочный мотор
CZ Lodní motor
SK Lodný motor
HU Csónakmotor
RO Motor de barca

Kod EAN
5901477136474

John Gardener
Kod produktu
G81045 1



GB Tourist shower
DE Touristendusche
RU Туристический душ
CZ Turistická sprcha
SK Turistická sprcha
HU Turisztikai zuhany
RO Duş turistic

Kod EAN
5901477176746

Kod produktu
K00401 25

190x80 cm

200kg

GB Garden hammock
DE Garten-Hängematte
RU Садовый гамак
CZ Zahradní houpačí síť
SK Záhradná hojďacia sieť
HU Kerti függőágy
RO Hamac de grădină

Kod EAN
5901477188473

Kod produktu
K02390 20

Hamak ogrodowy 190x80cm 200kg

190x150 cm

200kg

GB Garden two-bed hammock
DE Garten-Hängematte mit zwei Betten
RU Двухместный гамак в саду
CZ Zahradní houpačí síť se dvěma lůžky
SK Záhradná hojďacia sieť s dvoma lôžkami
HU Kerti kétágyas függőágy
RO Hamac de grădină cu două paturi

Kod EAN
5901477188466

Kod produktu
K02391 15

Hamak ogrodowy 2os z drewnianym stabilizatorem 190x150cm 200kg

200x100 cm

200kg

GB Garden hammock with frame
DE Gartenhängematte mit Gestell
RU Садовый гамак с каркасом
CZ Zahradní houpačí síť s rámem
SK Záhradná hojďacia sieť s rámom
HU Kerti függőágy kerettel
RO Hamac de grădină cu cadru

Kod EAN
5901477188589

Kod produktu
K02392 1

Hamak ogrodowy ze stelażem 200x100cm 200kg

12V

MAX 60W

10 litr/min

GB Tourist shower
DE Touristische Dusche
RU Туристический душ
CZ Turistická sprcha
SK Turistická sprcha
HU Turisztikai zuhanyzó
RO Duș turistic

Kod EAN
5901477184963

Kod produktu
K00403 10

Prysznic turystyczny 12V

GB Folding tourist chair
DE Faltbarer Touristenstuhl
RU Складной стул для туристов
CZ Skládací turistické křeslo
SK Skladacia turistická stolička
HU Összecsukható turista szék
RO Scaun turistic pliabil

Kod EAN
5901477189418

Kod produktu
K00409A 10

Krzesło składane turystyczne + pokrowiec (czarne)

GB Folding tourist chair
DE Faltbarer Touristenstuhl
RU Складной туристический стул
CZ Skládací turistické křeslo
SK Skladacia turistická stolička
HU Összecsukható turista szék
RO Scaun turistic pliabil

Kod EAN
5901477189425

Kod produktu
K00409B 10

Krzesło składane turystyczne + pokrowiec (zielone)

GB Folding tourist chair
DE Faltbarer Touristenstuhl
RU Складной стул для туристов
CZ Skládací turistické křeslo
SK Skladacia turistická stolička
HU Összecsukható turista szék
RO Scaun turistic pliabil

Kod EAN
5901477189432

Kod produktu
K00409C 10

Krzesło składane turystyczne + pokrowiec (moro)

GB Folding tourist stool
DE Faltbarer Touristenhocker
RU Складной туристический стул
CZ Skládací turistická stolička
SK Skladacia turistická stolička
HU Összecsukható turistaszék
RO Scaun turistic pliabil

Kod EAN
5901477189197

Kod produktu
K00408A 50

Krzeselko – mini taboret składany turystyczny (czarny)



200x200
cm

GB Folding tourist stool
DE Faltbarer Touristenhocker
RU Складной туристический стул
CZ Skládací turistická stolička
SK Skladacia turistická stolička
HU Összecsukható turisztaszék
RO Scaun turistic pliabil



Krzeselko – mini taboret składany turystyczny (zielony) K00408B 50



GB Folding tourist stool
DE Faltbarer Touristenhocker
RU Складной туристический стул
CZ Skládací turistická stolička
SK Skladacia turistická stolička
HU Összecsukható turisztaszék
RO Scaun turistic pliabil



Krzeselko – mini taboret składany turystyczny (moro) K00408C 50



GB Insulated beach blanket
DE Isoliertes Stranddecke
RU Изолированное пляжное одеяло
CZ Izolovaná plážová deka
SK Izolovaná plážová deka
HU Szigetelt strandtakaró
RO Pătură de plajă izolată



Koc plážowy z izolacją 200x200 (szaro-niebieski) K00420A 12

5.5L

23x11x19
cm



GB Thermal bag
DE Thermosack
RU Термосумка
CZ Termotaška
SK Termotaška
HU Hőtasák
RO Geantă termică



Torba termiczna 5.5L K00428 100

18L

35x28x20
cm



GB Thermal bag with two cooling inserts
DE Thermotasche mit zwei Kühlinsätzen
RU Термосумка с двумя охлаждающими вкладышами
CZ Termotaška s dvěma chladiacími vložkami
SK Termotaška s dvomi chladiacími vložkami
HU Hőtasák két hűtőbetéttel
RO Pungă termică cu două inserții de răcire



Torba termiczna 18L + dwa wkłady chłodzące K00430 1

28L

40x28x30
cm



GB Thermal bag with two cooling inserts
DE Thermotasche mit zwei Kühlinsätzen
RU Термосумка с двумя охлаждающими вкладышами
CZ Termotaška s dvěma chladiacími vložkami
SK Termotaška s dvomi chladiacími vložkami
HU Hőtasák két hűtőbetéttel
RO Pungă termică cu două inserții de răcire



Torba termiczna 28L + dwa wkłady chłodzące K00431 1

30L

45x27x22
cm



GB Thermal foldable picnic basket
DE Thermischer faltbarer Picknickkorb
RU Термическая складная корзина для пикника
CZ Tepelný skládací piknikový koš
SK Tepelný skládací piknikový koš
HU Termikus összecsukható piknikkosár
RO Coș de picnic pliabil termic



Koszyk termiczny składany piknikowy 30L K00425 20



GB Aluminum bicycle phone holder
DE Aluminium-Fahrrad-Telefonhalter
RU Алюминиевый держатель для телефона на велосипеде
CZ Hliníkový držák telefonu na kolo
SK Hliníkový držák telefónu na bicykel
HU Alumínium kerékpáros telefontartó
RO Suport de telefon din aluminiu pentru biciclete



Aluminiowy uchwyt rowerowy G-81 na telefon Kod produktu **K02341** 100



GB Aluminum bicycle phone holder
DE Aluminium-Fahrrad-Telefonhalter
RU Алюминиевый держатель для телефона на велосипеде
CZ Hliníkový držák telefonu na kolo
SK Hliníkový držák telefónu na bicykel
HU Alumínium kerékpáros telefontartó
RO Suport de telefon din aluminiu pentru biciclete



Aluminiowy uchwyt rowerowy G-85 na telefon Kod produktu **K02342** 100



GB Waterproof bicycle bag
DE Wasserdichte Fahrradtasche
RU Водонепроницаемая сумка для велосипеда
CZ Vodotěsná brašna na kolo
SK Vodotesná taška na bicykel
HU Vízálló kerékpáros táská
RO Geantă impermeabilă pentru biciclete



Wodoodporna torba-sakwa rowerowa na rzep z uchwytem na tel. Kod produktu **K02324** 40



GB Wall hanger for a bicycle
DE Wandhalterung für ein Fahrrad
RU Настенная вешалка для велосипеда
CZ Nástěnný věšák na jízdní kolo
SK Nástenný vešiak na bicykel
HU Falra akasztó kerékpárhoz
RO Cârlig de perete pentru o bicicletă



Torba – sakwa rowerowa tylna pod siodełko Kod produktu **K02325** 100



GB Waterproof bicycle saddle bag
DE Wasserdichte Fahrradsatteltasche
RU Водонепроницаемая сумка для велосипедного седла
CZ Vodotěsná brašna pod sedlo jízdního kola
SK Vodotesná taška na sedlo bicykla
HU Vízálló kerékpár nyereg táská
RO Geantă de șa de bicicletă impermeabilă



Wodoodporna torba – sakwa rowerowa tylna pod siodełko Kod produktu **K02326** 70



GB Thermal bicycle rack bag
DE Thermische Fahrradträger tasche
RU Термосумка для велосипедного багажника
CZ Termobrašna na nosič jízdního kola
SK Tepelná taška na nosič bicykla
HU Termikus kerékpártartó táská
RO Geantă termică pentru rack de bicicletă



Torba termiczna na bagażnik rowerowy Kod produktu **K02329** 35



GB Triangular velcro bicycle frame bag
DE Dreieckige Fahrradrahmentasche mit Klettverschluss
RU Треугольная сумка на липучке для велосипедной рамы
CZ Trojúhelníková brašna na rám jízdního kola na suchý zip
SK Trojhranná taška na rám bicykla na suchý zips
HU Háromszögletes tépőzáras kerékpár táská
RO Geantă triunghiulară cu velcro pentru cadru de bicicletă



Torba – sakwa rowerowa na rzep pod ramę Kod produktu **K02321** 300



GB Aluminum bicycle bottle holder
DE Fahrradflaschenhalter aus Aluminium
RU Алюминиевый держатель для велосипедных бутылок
CZ Hliníkový držák na fľašu na bicykel
SK Hliníkový držák na fľašu na bicykel
HU Alumínium kerékpáros palacktartó
RO Suport pentru sticle de bicicletă din aluminiu



Aluminiowy uchwyt rowerowy na bidon + śruby montażowe Kod produktu **K02371** 300



GB Adjustable bicycle water bottle holder
DE Verstellbarer Fahrradflaschenhalter
RU Регулируемый держатель бутылки для воды на велосипеде
CZ Nastavitelný držák lahve na vodu na kolo
SK Nastavitelný držák na fľašu na vodu na bicykli
HU Állítható kerékpáros palacktartó
RO Suport reglabil pentru sticlă de apă pentru bicicletă



Uchwyt rowerowy na bidon – regulowany + śruby montażowe Kod produktu **K02372** 120



GB Rear aluminium bicycle rack
DE Hinterer Aluminium-Fahrradträger
RU Задний алюминиевый багажник для велосипедов
CZ Zadní hliníkový nosič jízdních kol
SK Zadný hliníkový nosič na bicykel
HU Hátsó alumínium kerékpártartó
RO Suport pentru biciclete din aluminiu din spate



Bagażnik rowerowy tylny aluminiowy 50kg Kod produktu **K02353** 18



GB Adjustable bicycle kickstand
DE Verstellbarer Fahrradständer
RU Регулируемая стойка для велосипеда
CZ Nastavitelný stojan na kolo
SK Nastavitelný stojan na bicykel
HU Állítható kerékpár állvány
RO Suport reglabil pentru biciclete



Stopka rowerowa centralna - regulowana 24"-29" Kod produktu **K02357** 50



GB Aluminum bicycle bell
DE Aluminium Fahrradklingel
RU Алюминиевый велосипедный звонок
CZ Hliníkový zvonček na kolo
SK Hliníkový zvonček na bicykel
HU Alumínium kerékpáros csengő
RO Clopot de bicicletă din aluminiu



Dzwonek rowerowy aluminiowy Kod produktu **K02359** 1000



GB Foam bicycle seat
DE Fahrradsitz aus Schaumstoff
RU Сиденье велосипеда из пеноматериала
CZ Pěnová sedačka na kolo
SK Penové sedadlo na bicykel
HU Hab bicikliülés
RO Scaun de bicicletă din spuma



5901477186752

Siodelko rowerowe piankowe z odblaskiem Kod produktu **K02328** 30



GB Gel cover for a bicycle saddle
DE Gelüberzug für einen Fahrradsattel
RU Гелевый чехол для велосипедного седла
CZ Gelový potah na sedlo jízdní kola
SK Gélový potah na sedlo bicykla
HU Gél borítás kerékpár nyereghez
RO Înveliș cu gel pentru o șa de bicicletă



5901477186066

Pokrowiec – nakładka żelowa na siodełko rowerowe Kod produktu **K02327** 100



GB Foldable wall hanger for a bicycle
DE Zusammenklappbarer Wandaufhänger für ein Fahrrad
RU Складная настенная вешалка для велосипеда
CZ Skládací nástěnný věšák na jízdní kolo
SK Skládací nástěnný vešiak na bicykel
HU Összecsukható falí fogás kerékpárhoz
RO Cârlig de perete pliabil pentru o bicicletă



5901477185212

Wieszak ścienny składany na rower 36x30x48cm Kod produktu **K02385** 10

GB Bicycle floor stand
DE Fahrradbodenständer
RU Напольная подставка для велосипеда
CZ Podlahový stojan na jízdní kolo
SK Podlahový stojan na bicykel
HU Kerékpár állvány
RO Suport de podea pentru bicicletă



5901477187797

Stojak rowerowy serwisowy – uchwyt na koło 16-29" Kod produktu **K02387** 10

GB Wall hanger for a bicycle
DE Wandhalterung für ein Fahrrad
RU Настенная вешалка для велосипеда
CZ Nástěnný věšák na jízdní kolo
SK Nástěnný vešiak na bicykel
HU Falra akasztó kerékpárhoz
RO Cârlig de perete pentru o bicicletă



5901477185229

Uchwyt – wieszak ścienny na rower Kod produktu **K02382** 100



GB Wall hanger for a bicycle
DE Wandhalterung für ein Fahrrad
RU Настенная вешалка для велосипеда
CZ Nástěnný věšák na jízdní kolo
SK Nástěnný vešiak na bicykel
HU Falra akasztó kerékpárhoz
RO Cârlig de perete pentru o bicicletă



5901477185250

Wieszak rowerowy na ścianę – uchwyt na koło Kod produktu **K02381** 50



GB Bicycle cable lock
DE Kabelschloss für Fahrräder
RU Велосипедный тросовый замок
CZ Kabelový zámek na kolo
SK Káblový zámek na bicykel
HU Kerékpár kábelzár
RO Încuietoare cu cablu pentru bicicletă



5901477185090

Zapięcie rowerowe – łańcuch na klucz 6/900mm Kod produktu **K02306** 20



GB Bicycle cable lock
DE Kabelschloss für Fahrräder
RU Велосипедный тросовый замок
CZ Kabelový zámek na kolo
SK Káblový zámek na bicykel
HU Kerékpár kábelzár
RO Încuietoare cu cablu pentru bicicletă



5901477185182

Zapięcie rowerowe – łańcuch na klucz 8/1200mm Kod produktu **K02307** 20



GB Bicycle cable lock
DE Kabelschloss für Fahrräder
RU Велосипедный тросовый замок
CZ Kabelový zámek na kolo
SK Káblový zámek na bicykel
HU Kerékpár kábelzár
RO Încuietoare cu cablu pentru bicicletă



5901477185076

Zapięcie rowerowe na 4 cyfrowy szyfr 12x800mm Kod produktu **K02300** 60



GB Bicycle cable lock
DE Kabelschloss für Fahrräder
RU Велосипедный тросовый замок
CZ Kabelový zámek na kolo
SK Káblový zámek na bicykel
HU Kerékpár kábelzár
RO Încuietoare cu cablu pentru bicicletă



5901477185083

Zapięcie rowerowe na klucz 12x800mm Kod produktu **K02303** 60



GB Bicycle cable lock
DE Kabelschloss für Fahrräder
RU Велосипедный тросовый замок
CZ Kabelový zámek na kolo
SK Káblový zámek na bicykel
HU Kerékpár kábelzár
RO Încuietoare cu cablu pentru bicicletă



5901477185144

Zapięcie rowerowe na klucz 12x1200mm Kod produktu **K02304** 60

Kalosze / Rubber boots



Kod EAN
5901477184475
Kod EAN
5901477184482
Kod EAN
5901477184499
Kod EAN
5901477184505
Kod EAN
5901477184512
Kod EAN
5901477184529
Kod EAN
5901477184536
Kod EAN
5901477184543

GB Men's rain boots
 DE Herren - Gummistiefel
 RU Галоши мужские
 CZ Pánské galoše
 SK Pánske galoše
 HU Férfi gumicsizma
 RO Cizme bărbați

Kod produktu		
Kalosze męskie czarne r.39	G90547-39	5
Kalosze męskie czarne r.40	G90547-40	5
Kalosze męskie czarne r.41	G90547-41	5
Kalosze męskie czarne r.42	G90547-42	5
Kalosze męskie czarne r.43	G90547-43	5
Kalosze męskie czarne r.44	G90547-44	5
Kalosze męskie czarne r.45	G90547-45	5
Kalosze męskie czarne r.46	G90547-46	5



GB Women's rain boots
 DE Damen - Gummistiefel
 RU Галоши женские
 CZ Dámské galoše
 SK Dámske galoše
 HU Női gumicsizma
 RO Cizme damă

Kod produktu		
Kalosze damskie EVA r.36	G90548-36	7
Kalosze damskie EVA r.37	G90548-37	7
Kalosze damskie EVA r.38	G90548-38	7
Kalosze damskie EVA r.39	G90548-39	7
Kalosze damskie EVA r.40	G90548-40	7

Kod EAN
5901477184550
Kod EAN
5901477184567
Kod EAN
5901477184574
Kod EAN
5901477184581
Kod EAN
5901477184598



GB Men's rain boots
 DE Herren - Gummistiefel
 RU Галоши мужские
 CZ Pánské galoše
 SK Pánske galoše
 HU Férfi gumicsizma
 RO Cizme bărbați

Kod produktu		
Kalosze męskie EVA r.41	G90549-41	6
Kalosze męskie EVA r.42	G90549-42	6
Kalosze męskie EVA r.43	G90549-43	6
Kalosze męskie EVA r.44	G90549-44	6
Kalosze męskie EVA r.45	G90549-45	6
Kalosze męskie EVA r.46	G90549-46	6

Kod EAN
5901477184604
Kod EAN
5901477184611
Kod EAN
5901477184628
Kod EAN
5901477184635
Kod EAN
5901477184642
Kod EAN
5901477184659

Gumofilce / Rubber boots with felt lining



Kod EAN

5901477184666

Kod EAN

5901477184673

Kod EAN

5901477184680

Kod EAN

5901477184697

Kod EAN

5901477184703

Kod EAN

5901477184710

Kod EAN

5901477184727

GB Felt PVC boots
 DE Gummistiefel mit Filtz
 RU Сапоги резиновые с войлоком
 CZ Holinky s filcem
 SK Čizmy s filcom
 HU Gumi - filc csizma
 RO Cizme PVC



Kod EAN

5901477184734

Kod EAN

5901477184741

Kod EAN

5901477184758

Kod EAN

5901477184765

Kod EAN

5901477184772

Kod EAN

5901477184789

Kod EAN

5901477184796

Kod EAN

5901477184802

GB Felt PVC boots
 DE Gummistiefel mit Filtz
 RU Сапоги резиновые с войлоком
 CZ Holinky s filcem
 SK Čizmy s filcom
 HU Gumi - filc csizma
 RO Cizme PVC

	Kod produktu	
Gumofilce męskie EVA r.40	G90550-40	6
Gumofilce męskie EVA r.41	G90550-41	6
Gumofilce męskie EVA r.42	G90550-42	6
Gumofilce męskie EVA r.43	G90550-43	6
Gumofilce męskie EVA r.44	G90550-44	6
Gumofilce męskie EVA r.45	G90550-45	6
Gumofilce męskie EVA r.46	G90550-46	6

	Kod produktu	
Gumofilce męskie r.39	G90551-39	6
Gumofilce męskie r.40	G90551-40	6
Gumofilce męskie r.41	G90551-41	6
Gumofilce męskie r.42	G90551-42	6
Gumofilce męskie r.43	G90551-43	6
Gumofilce męskie r.44	G90551-44	6
Gumofilce męskie r.45	G90551-45	6
Gumofilce męskie r.46	G90551-46	6

Chodaki / Clogs



GB Clogs
DE Holzschuhe
RU Сабо
CZ Dřeváky
SK Dreváky
HU Facipők
RO Saboți

GB Clogs
DE Holzschuhe
RU Сабо
CZ Dřeváky
SK Dreváky
HU Facipők
RO Saboți

	Kod produktu	
Chodaki EVA r.36	G90555-36	16
Chodaki EVA r.37	G90555-37	16
Chodaki EVA r.38	G90555-38	16
Chodaki EVA r.39	G90555-39	16
Chodaki EVA r.40	G90555-40	16

	Kod produktu	
Chodaki EVA r.41	G90555-41	16
Chodaki EVA r.42	G90555-42	16
Chodaki EVA r.43	G90555-43	16
Chodaki EVA r.44	G90555-44	16
Chodaki EVA r.45	G90555-45	16
Chodaki EVA r.46	G90555-46	16

Kod EAN

5903418308094

Kod EAN

5903418308100

Kod EAN

5903418308117

Kod EAN

5903418308124

Kod EAN

5903418308131

Kod EAN

5903418308148

Kod EAN

5903418308155

Kod EAN

5903418308162

Kod EAN

5903418308179

Kod EAN

5903418308186

Kod EAN

5903418308193

Kod produktu	Strona	Kod produktu	Strona	Kod produktu	Strona	Kod produktu	Strona	Kod produktu	Strona	Kod produktu	Strona	Kod produktu	Strona	Kod produktu	Strona
CG74096A	91	G70016	90	G71000	123	G72901	75	G73245	58	G73995	20	G81065F	11	G82001	69
CG80360A	122	G70020	90	G71002	118	G72902A	76	G73246	58	G73995-1	20	G81065F	13	G81524	69
CG80361A	122	G70021	90	G71005	118	G72903	76	G73247	55	G73995-2	20	G81065S	13	G81525	70
CG80362A	122	G70022	90	G71006	118	G72903A	76	G73249	55	G73996	20	G81065Z	14	G81526	69
CG80515-0	128	G70025	89	G71007	121	G72907	76	G73251	54	G73997	20	G81066	16	G81527	70
CG80515-4	128	G70026	89	G71008	121	G72907A	76	G73252	54	G73998	20	G81066C	11	G81528	69
CG80516-0	128	G70027	89	G71009	120	G72910	80	G73253	56	G73998-1	20	G81066D	12	G81529	73
CG80516-4	128	G70028	89	G71010	120	G72911	79	G73256	57	G73998-2	20	G81066E	12	G81620	69
CG80668E	9	G70033	89	G71012	118	G72915	79	G73257	57	G73998-3	20	G81066W	12	G81621	142
CG80668F	9	G70034	89	G71014	119	G72919	79	G73263	55	G73998-4	20	G81066X	12	G81622	142
CG80668G	9	G70035	89	G71015	121	G72920	79	G73265	56	G73998-5	20	G81066Y	16	G81623	142
CG80668H	9	G70040	90	G71017	119	G72925	76	G73265-2	56	G73999	20	G81067G	12	G81665	143
CG83015-1	8	G70041	90	G71018	120	G72926	76	G73266	57	G74000	27	G81067S	12	G81665A	142
CG83016-1	9	G70042	91	G71019	120	G72931	79	G73267	57	G74001	27	G81067Y	12	G81666	142
D00001	106	G70072	72	G71020	120	G72931A	77	G73271	55	G74002	28	G81067Y	13	G82001	142
D00002	106	G70075	72	G71022	119	G72932	77	G73273	55	G74003	28	G81068A	11	G82002	26
D00003	106	G70100	91	G71023	119	G72932A	77	G73274	55	G74006	28	G81068B	12	G82005	26
D00004	106	G70101	91	G71024	119	G72933	77	G73275	55	G74008	28	G81068C	12	G82007	26
D00005	107	G70102	91	G71025	119	G72933A	77	G73291	131	G74009	28	G81068D	15	G82008	27
D00006	107	G70102A	91	G71026	119	G72934	77	G73293	132	G74010	28	G81068E	12	G82009	27
D00007	107	G70102B	91	G71027	119	G72934A	77	G73294	132	G74011	28	G81068G	12	G82010	32
D00008	107	G70104	91	G71028	119	G72935	79	G73295	132	G74012	28	G81068J	13	G82011	125
D00009	107	G70104A	91	G71029	120	G72939	79	G73296	132	G74018	28	G81068M	13	G82012	125
D00010	107	G70105	91	G71030	120	G72939A	78	G73298	133	G74019	28	G81068N	14	G82015	125
G00649	16	G70106	91	G71031	120	G72940	77	G73320	132	G74026	28	G81068O	14	G82016	125
G01890	146	G70107	91	G71032	121	G72940A	77	G73321	132	G74027	28	G81068P	17	G82024	125
G01891	146	G70108	91	G71033	121	G72941	77	G73322	133	G74028	28	G81068U	13	G82025	125
G01892	147	G70109	91	G71034	121	G72941A	77	G73331	135	G74030	29	G81068W	13	G82955	125
G01892A	147	G70110	84	G71035	121	G72945	78	G73332	135	G74040	29	G81068X	13	G82956	133
G01901	147	G70111	84	G71036	121	G72945A	78	G73333	135	G74050	29	G81068Z	11	G83003	133
G01902	147	G70112	84	G71040	119	G72946	78	G73502A	111	G74060	29	G81069B	13	G83004	23
G01903	147	G70120	84	G71041	119	G72946A	78	G73502C	111	G74070	29	G81069D	14	G83005	23
G01904	146	G70121	84	G71042	119	G72947	78	G73503	112	G74080	29	G81069E	17	G83007	23
G01905	146	G70122	84	G71043	121	G72949	78	G73504	111	G74090	29	G81069F	13	G83008	35
G01927	93	G70123	84	G71046	120	G72949A	78	G73507	111	G74092	30	G81069G	14	G83009	26
G01928	93	G70124	84	G71047	120	G72950	78	G73511	111	G74093	30	G81069H	14	G83011	35
G01930	93	G70125	85	G71048	120	G72950A	78	G73512	111	G74094	30	G81069J	14	G83012	35
G01931	93	G70126	85	G71049	121	G72951	78	G73513	111	G74095	30	G81069K	14	G83013	35
G01932	93	G70130	85	G71109	134	G72951A	78	G73521	112	G74096	30	G81069L	14	G83014	35
G01933	93	G70131	85	G71126	134	G72952	79	G73522	112	G74097	31	G81069M	16	G83015	35
G01934	93	G70132	85	G71980A	138	G72955	81	G73523	112	G74098	31	G81069N	16	G83016	8
G01935	93	G70133	85	G71980B	138	G72956	81	G73530	112	G74099	31	G81069N	16	G83018	8
G01936	93	G70140	85	G71981A	138	G72959	79	G73531	112	G75000	114	G81069O	14	G83025	15
G01937	93	G70141	85	G71981B	138	G72962	77	G73532	112	G75001	114	G81069P	14	G83026	5
G01938	93	G70150	84	G71982A	138	G72965	80	G73533	112	G75002	114	G81069R	14	G83027	5
G01939	93	G70151	84	G71982B	138	G72966	81	G73534	112	G75003	114	G81069S	16	G83028	5
G01940	93	G70152	84	G71983A	138	G72967	80	G73542	112	G75010	114	G81069T	15	G83040	5
G01960	93	G70153	84	G71983B	138	G72970	79	G73543	112	G75011	114	G81069U	17	G83041	134
G01962	93	G70156	85	G71984A	138	G72980	71	G73552	112	G75012	114	G81069V	15	G83050	134
G01964	93	G70157	85	G71984B	138	G72981	71	G73553	112	G75013	114	G81069X	17	G83051	2
G01966	93	G70180	85	G71985A	138	G73000	75	G73572	113	G75014	114	G81069Y	17	G83052	2
G01968	93	G70181	85	G71985B	138	G73008	75	G73573	113	G75015	114	G81069Z	17	G83053	3
G01971	93	G70182	86	G72001	43	G73009	75	G73585	113	G75021	114	G81069A	13	G83054	3
G01972	93	G70183	85	G72002	43	G73012	75	G73586	113	G75022	114	G81070	25	G83055	3
G01973	93	G70184	86	G72003	43	G73020	73	G73587	113	G75023	115	G81071	25	G83056	3
G01974	93	G70185	86	G72005	43	G73021	73	G73590	113	G75024	115	G81075	52	G83059	3
G02153	127	G70186	86	G72006	39	G73022	73	G73591	113	G75031	115	G81080	53	G83060	3
G02183	131	G70187	86	G72007	39	G73023	73	G73592	113	G75035	115	G81081	53	G83061	136
G02420	148	G70188	86	G72008	39	G73025	73	G73595	113	G75043	115	G81082	53	G83062	136
G02633	135	G70189	86	G72009	136	G73026	73	G73596	113	G75060	111	G81106	15	G84001	136
G03208	135	G70190	86	G72009A	136	G73027	73	G73597	113	G75061	111	G81107	32	G84002	22
G03230	126	G70191	86	G72009B	136	G73030	73	G73599	113	G75062	111	G81108	32	G84005	21
G03231	126	G70192	87	G72011	43	G73030B	74	G73691	73	G75063	111	G81109	32	G84007	21
G03232	126	G70193	87	G72012	42	G73031	74	G73692	72	G75064-L	115	G81110	15	G84008	15
G03233	126	G70194	87	G72014	42	G73031B	74	G73693	72	G75200-M	115	G81111	32	G84009	22
G03236	127	G70198	86	G72017	40	G73032	74	G73694	72	G75200-S	115	G81112	32	G84010	23
G03237	127	G70199	86	G72018	40	G73032B	74	G73695	73	G75200-XXL	115	G81113	32	G84011	24
G03240	127	G72020	40	G72020	40	G73033	74	G73696	73	G75200-XXL	115	G81114	32	G84012	24
G03241	127	G72021	40	G72021	40	G73033B	74	G73697	73	G75201-L	115	G81115	32	G84015	25
G03242	127	G72025	40	G72022	40	G73035	74	G73698	73	G75201-M	115	G81116	32	G84016	21
G03247	134	G72026	40	G72023	40	G73036	74	G73699	73	G75201-L	115	G81117	32	G84020	22
G10920	131	G72021	40	G72024	41	G73037	74	G73780	72	G75201-XXL	115	G81119	33	G84021	97
G10921	130	G72022	40	G72025	41	G73038	74	G73781	72	G75201-XXL	115	G81120	33	G84022	97
G10922	130	G72023	40	G72026	41	G73039	74	G73782	72	G78180	16	G81121	33	G84023	98
G10923	130	G72024	40	G72027	41	G73040	75	G73783	72	G78181	16	G81122	33	G84024	99
G10924	130	G72025	40	G72028	41	G73041	75	G73785	72	G78182	16	G81123	33	G90547-39	99
G15112	148	G72026	40	G72029	41	G73042	75	G73786	72	G80249	123	G81124	33	G90547-40	154
G15115	148	G72027	88	G72040	108	G73043	75	G73787	72	G80250	124	G81125	33	G90547-41	154
G15122	148	G72028	87	G72041	108	G73047	75	G73788	72	G80251	124	G81126	33	G90547-42	154
G20035	58	G70305	94	G72042	108	G73048	75	G73789	72	G80252	124	G81130	33	G90547-43	154
G20036	58	G70306	94	G72043	108	G73050	79	G73800	81	G80253	124	G81131	33	G90547-44	154
G20075	149	G70310	94	G72044	108	G73051	79	G73801	81	G80254	124	G81135	33	G90547-45	154
G20076	149	G70311	94	G72045	109	G73056	80	G73802	81	G80360	122	G81136	33	G90547-46	154
G30124	32	G70312	94	G72046	109	G73064	82	G73							



Box / Karton



Blister card / Blister



Polybag with header card / Torebka foliowa z kartonową zawieszką



Polybag / Woreczek foliowy



Header card / Kartonowa zawieszka



Flag tied on card / Zawieszka flaga



Bulk / Luz



Shrink bag / Worek termokurczliwy



Sleeve / Rękaw



Pocket case / Kieszon typu piórnik



Plastikowa zawieszka / Plastic hanger



Współpracujemy z Partnerami z całej Polski jak i zagranicy, zapewniając im atrakcyjne warunki handlowe. Dodatkowo oferujemy wsparcie merytoryczne, sprzedażowe oraz marketingowe.

Kooperujemy ze sklepami, hurtowniami na rynku tradycyjnym jak i e-commerce.

We cooperate with Partners from all over Poland and abroad, providing them with attractive trading conditions. Additionally, we offer substantive, sales and marketing support. We cooperate with shops, wholesalers on the traditional market as well as e-commerce.

Z wieloma partnerami współpracujemy od początku naszego istnienia. Przekazujemy naszą wiedzę oraz rozwiązania a także stale się uczymy najnowszych metod komunikacji, które przekazujemy naszym partnerom.

We have been working with many partners since the beginning of our existence. We share our knowledge and solutions and also constantly learn the latest communication methods, which we pass on to our partners.

Jeżeli szukasz stabilnego dostawcę, który:

- jest właścicielem marek, które oferuje
- nieustannie rozwija portfolio produktowe
- oferuje produkty z różnych przedziałów jakościowo cenowych
- udziela atrakcyjne warunki handlowe z którym możesz zbudować
- ekspozycję handlową w swoim lokalu
- zapewnia ciągłość dostaw pozwoli Ci na rozwój Twojej działalności

If you are looking for a stable supplier who:

- is the owner of the brands he offers
- constantly develops his product portfolio
- offers products from different quality and price ranges
- grants attractive trading conditions with which you can build
- a commercial exposure in your premises
- ensures continuity of supplies that will allow you to develop your business

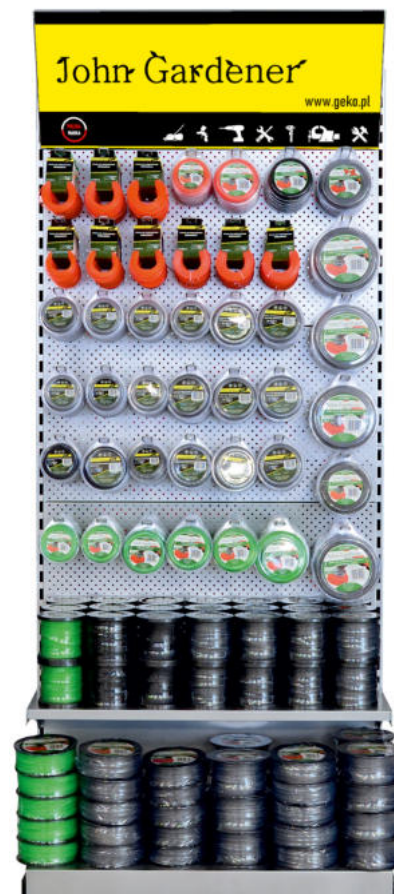

John Gardener



Kontakt

GEKO SPÓŁKA Z OGRANICZONĄ ODPOWIEDZIALNOŚCIĄ SPÓŁKA KOMANDYTOWA
ul. Spacerowa 3
97-500 Kietlin
Polska
(+48) 44 682 40 04
geko@geko.pl

NIP PL7722420459
384981078

Spółka zarejestrowana jest przez Sąd Rejonowy dla Łodzi-Śródmieścia w Łodzi, XX Wydział Krajowego Rejestru Sądowego pod numerem KRS 0000849187

Biuro obsługi klienta

tel.: (+48) 44 682 40 04 | e-mail: geko@geko.pl

Serwis gwarancyjny i pogwarancyjny GEKO

tel.: (+48) 698-642-358 | e-mail: serwis@geko.pl

